

V&V Valli&Valli

ASSA ABLOY



CATALOGO | *CATALOGUE*

Experience a safer
and more open world



Beautiful & Italian handles



Indice generale | *General index*

Gamma finiture <i>Range of Finishes</i>	pag. 10
Zirtanio - PVD	pag. 12
Rosetta fine <i>Slim Rosette</i>	pag. 14
Le nostre collezioni <i>Our collections</i>	pag. 15
Catalogo Prodotti <i>Product Catalogue</i>	pag. 16
Informazioni tecniche <i>Technical information</i>	pag. 159
Programma kit porte blindate <i>Kits set for security doors</i>	pag. 177
Sistemi di fissaggio <i>Fixing versions available</i>	pag. 187
Legenda codici <i>Legend of articles identification codes</i>	pag. 188
Certificazioni <i>Certification</i>	pag. 190



Hand made & Made in Italy

Rinascere ogni giorno con oltre 85 anni di storia alle spalle, con le radici nella tradizione italiana, dove la realtà artigianale si fonde con quella industriale. Guardare al futuro ogni giorno, in modo differente, ispirati all'arte, ai paesaggi e alle meraviglie che ci circondano.

Queste sono le attitudini di Valli&Valli, adagiata nel cuore della Brianza, nella terra fertile che genera tendenze e primeggia nel design internazionale.

Perché per primi, nel dopoguerra, esprimiamo il concetto di maniglia come pezzo unico, come scultura da prendere in mano.

Per primi, nel 1968, ci discostiamo dalle linee semplici e dirette, cambiamo completamente il design, studiamo una forma rivoluzionaria e diamo vita alla serie Medicea, la maniglia che ottiene il più alto record di vendite, destinata ad essere la più imitata al mondo.

Per primi attraversiamo gli oceani e diffondiamo l'eccellenza della maniglia made in Italy nel mondo.

Successful after more than 85 years of history rooted in Italian tradition, Valli&Valli is where the artisan rubs shoulders with industry.

Looking to the future with fresh eyes, the company is inspired by art, landscapes, and the wonders of this world.

This is Valli&Valli's mindset. The company is based in the heart of Brianza, a fertile trendsetting land that excels in international design.

During the post-war period, Valli&Valli was the first to see the handle as a unique piece of sculpture to be held and touched.

In 1968, it was the first to distance itself from simple, direct lines, and in its Medicea range completely revolutionised the design of handles.

This innovative product broke all sales records and became the world's most imitated handle.

Valli&Valli was the first to cross the oceans and spread the excellence of the Italian-made handle worldwide.

Technology & Innovation

Valli&Valli è la ricerca del bello in ogni cosa, in ogni progetto, in ogni dettaglio. È lo studio dell'equilibrio e dell'armonia tra materia e design, estetica e funzione, tecnologia e artigianato. È la sintesi di prestazioni, affidabilità, forma e durata nel tempo: in una parola, qualità. Un valore vero, in cui crediamo profondamente e che rinnoviamo ogni giorno grazie all'innovativo processo di ingegnerizzazione che permette di declinare la concezione totalmente industriale in infinite personalizzazioni di materiali, finiture e colori.

L'attenzione verso l'innovazione è fondamentale per un approccio completo al prodotto e alla sua destinazione d'uso. Ogni maniglia è realizzata in Italia utilizzando metalli e materie prime selezionate, con la forza del Gruppo Assa Abloy che dal 2008 alimenta il DNA tecnologico e l'eccellenza tutta italiana di Valli&Valli.

Valli&Valli is synonymous with the pursuit of beauty, in every project and in all details; It involves a study of balance, harmony, material, design, aesthetics, function, technology and crafts. It is a combination of performance, reliability, shape and durability and quality.

We believe deeply in these values, which we maintain with our innovative engineering process that transmutes an industrial conception into an infinite array of customisations of materials, finishes and colours. Innovation is the key to adopting a comprehensive approach to products and their intended use.

Each handle is made in Italy using selected metals and raw materials, drawing on the strength of the Assa Abloy Group which has been enhancing Valli&Valli's technological strength and all-Italian excellence since 2008.





Sensitivity & Sustainability

L'attenzione per l'ambiente che ci circonda non è una frase fatta.
È un impegno profondo dedicato a tutti, dall'idea al prodotto finito, dal concept al brevetto perché ogni opera sia unica e tutelata.
È lo studio diligente dell'ergonomia, dell'interazione tra le persone e l'utilizzo quotidiano della maniglia.
È la responsabilità per la salute che si traduce in prodotti antimicrobici affinché ogni gesto sia sempre accompagnato dalla serenità.
È la sensibilità per un mondo più pulito, è l'ecosostenibilità come missione aziendale.
È anche la piena compatibilità con la bioarchitettura e con tutti gli attori di una progettazione consapevole e responsabile.

We do not just pay lip service to protecting the environment.
We have a profound, all-round commitment, encompassing the process from the initial idea to the finished product so that every item is unique and protected.
This involves the diligent study of ergonomics, of the interaction between people and the handle's daily use.
Safeguarding health, which results in the development of antimicrobial products which ensure that every action is accompanied by peace of mind.
With environmental sustainability as our corporate mission, we are driving a change for a cleaner world.
It is fully compatible with sustainable architecture and all those involved in developing an aware and responsible design.

Personality & Tailor-made

Scegliere è esplorazione, movimento di pensiero, libertà.

Scegliere significa vestire la propria personalità, rendere tangibile il proprio stile.

Valli&Valli esprime questi concetti offrendo la più pura espressione di scelta, presentando 34 finiture in grado di regalare un immenso panorama di possibilità, capaci di adeguarsi a ogni esigenza di stile e di progetto.

Having a choice means exploring, enjoying freedom of thought and expression.

Having a choice means enhancing your personality and making your style tangible.

Valli&Valli expresses these concepts by offering a wide range of choices, 34 finishes providing a wealth of possibilities which adapt to every style and project.



Personalizzazione Finiture | *Finishings Customisation*

ACCAIO INOX LUCIDO	POLISHED STAINLESS STEEL
ACCAIO INOX SATINATO	SATIN STAINLESS STEEL
OROLUCIDO ***	*** POLISHED BRASS
OROLUCIDO - PVD	POLISHED BRASS - PVD
ORSATIN ***	*** SATIN BRASS
ORSATIN - PVD	SATIN BRASS - PVD
ORSATOP ***	*** MATT BRASS
OROLUX	BRASS PLATED
ORANSAT ***	*** ANTIQUE GOLD/SATIN BRASS
OTTONE NATURALE	NATURAL BRASS
OTTONE ANTICO ***	*** ANTIQUE BRASS
PATINÈ ***	*** PATINÈ
BRUNITO ***	*** BRUNISHED
ANTICATO ***	*** ANTIQUE
CROMO	POLISHED CHROME
CROMO - PVD	POLISHED CHROME - PVD
CROMOSAT	SATIN CHROME

Ogni maniglia Valli&Valli è disponibile a listino in una determinata selezione di finiture STANDARD presente nella corrispondente pagina di prodotto.

Personalizzazione GAMMA FINITURE

1. È possibile personalizzare scegliendo una finitura NON STANDARD tra le 34 finiture disponibili in questa pagina alle seguenti condizioni:

- **Quantitativo minimo ordinabile:** 24 set
- **Tempi di consegna:** minimo 8 settimane, da concordare
- **Sovrapprezzo:** da concordare con il commerciale

La direzione commerciale si riserva di confermare la fattibilità, i quantitativi e le condizioni commerciali:

- previa visione del campione e/o del riferimento del colore specifico

2. È possibile personalizzare ulteriormente le maniglie Valli&Valli, per progetti, alle seguenti condizioni:

- su disegno specifico
- con finiture speciali

La direzione commerciale si riserva di confermare la fattibilità, i quantitativi e le condizioni commerciali:

- previa visione del campione e/o del riferimento del colore specifico

*** In collaborazione con Biocote®, offriamo uno specifico trattamento Antimicrobico, a protezione delle maniglie contro il proliferarsi di batteri. Il trattamento è disponibile solo sulle finiture selezionate, con tempi di consegna e prezzi, che variano in base al design del prodotto. Per maggiori dettagli contattare il Servizio clienti.

CROMOSAT - PVD	SATIN CHROME - PVD
NICKEL ***	*** NICKEL
NIKMAT ***	*** NIKMATT
NIKSATAN ***	*** ANTIQUE SATIN NICKEL
NICKEL NERO ***	*** NICKEL BLACK
BRONZSAT ***	*** BRONZSAT
BRONZSAT - PVD	BRONZSAT - PVD
BRONZOP ***	*** MATT BRONZE
BRONZO SCURO ***	*** DARK BRONZE
BRONZO - PVD	BRONZE - PVD
NEROPACO ***	*** MATT BLACK
BIANCOPACO ***	*** MATT WHITE
TITANIUM - PVD	TITANIUM - PVD
RAMEMATT ***	*** MATT COPPER
LIGHT BLACK ***	*** LIGHT BLACK
METALLO RAME LUCIDO	POLISHED PURE COPPER
METALLO RAME SATINATO	SATIN PURE COPPER

Every Valli&Valli handle is available in the price list with a certain selection of STANDARD finishes described in the corresponding product page.

Personalised RANGE OF FINISHES

1. Products can be personalised by choosing a NON STANDARD finish among the 34 finishes available on this page at the following conditions:

- Minimum quantity for orders: 24 set
- Delivery times: minimum 8 weeks, to be agreed
- Surcharge: to be agreed with the Business Management

The Business Management reserves the right to confirm feasibility, quantities and terms of sale:

- after seeing the sample and/or the specific colour code

2. Valli&Valli handles can be further personalised for projects at the following conditions:

- with a specific design
- with special finishes

The Business Management reserves the right to confirm feasibility, quantities and terms of sale:

- after seeing the sample and/or the specific colour code

*** In cooperation with BioCote®, we offer a specific anti-microbial surface treatment that ensures protection of the handles against bacteria colonies. This transparent anti-microbial treatment is available on request on selected finishes. Prices, and lead times vary based on lever design and product selection. For details please contact our customer service.

ZIRTANIO®

Breve descrizione del processo

La decorazione di particolari con la tecnica PVD (Physical Vapour Deposition) avviene mediante una deposizione di materiali pregiati che vengono trasferiti sulla superficie dell'oggetto con un processo fisico-chimico in condizioni di vuoto quasi assoluto. Il controllo dei numerosi parametri interessanti il processo può avvenire solo con strumentazioni elettroniche molto sofisticate: solamente con un controllo severo ed accurato di tali parametri è possibile ottenere caratteristiche decorative (lucentezza, colore) costanti nel tempo e caratteristiche meccaniche (aderenza, durezza) elevate.

Durata nel tempo

Il trattamento PVD è, allo stato attuale dell'arte, quello che garantisce la maggior resistenza agli attacchi atmosferici. I test di nebbia salina effettuati sui particolari di nostra produzione e condotti secondo la Norma Europea UNI EN 1906:2012 (e in modo ancor più specifico in conformità alla EN 1670 come descritto al punto 4.1.7) hanno superato il grado 5, che rappresenta il più alto grado raggiungibile e che determina la resistenza estremamente elevata alla corrosione. La prova è stata anche effettuata in modalità e in accordo alla norma UNI ISO 9227 (ITO-V-002) che ne attesta la resistenza effettiva a 1500 ore in nebbia salina, presso i nostri laboratori interni. Questo consente di garantire sui prodotti trattati PVD una maggior durata nel tempo di gran lunga superiori ai prodotti trattati galvanicamente o verniciati.

Attestato di qualità

Si attesta che il trattamento della superficie di tutte le colorazioni vengono sottoposte a rigorosi controlli interni secondo le Istruzioni Tecniche Operative e controlli di processo.

Tale trattamento ha superato i seguenti test:

- Resistenza alla Nebbia Salina secondo la norma UNI ISO 9227 (ITO-V-002)
- Shock termico secondo la norma UNI ISO 2819 (ITO-V-003)
- Cross Cut secondo la norma UNI ISO 2409 (ITO-V-008)
- Esposizione esterna (ITO-V-014)
- Resistenza di solidità alla luce senza alterazioni secondo la norma UNI ISO 9397 (ITO-V-013)

Per la pulizia consigliamo l'utilizzo di un panno inumidito con alcool.

* Si declina ogni responsabilità per un utilizzo negligente od improprio dei prodotti.



La maniglia ed i suoi coordinati, ormai divenuti veri complementi d'arredo, sono comunque oggetti di uso quotidiano e quindi, inevitabilmente, soggetti ad una naturale usura. Inoltre, particolari situazioni climatiche, agenti atmosferici come salsedine e umidità o l'utilizzo in situazioni gravose, possono accelerare questi processi, intaccando lo strato protettivo e generando effetti corrosivi con conseguenze antiestetiche.

Grazie al trattamento Zirtanio, che viene effettuato sulla superficie dei prodotti, Assa Abloy Italia garantisce la protezione. Trattandosi di una finitura a richiesta gli uffici commerciali restano a completa disposizione per ogni ulteriore informazione e chiarimento.

PVD

Physical Vapour Deposition

Short process description

The decoration of products by means of the PVD (Physical Vapour Deposition) technique is a coating process, that involves the deposition of precious materials on to the surface of the object following a physical-chemical process, in conditions which are next to absolute vacuum. The control of the various parameters of the process may be done through very sophisticated electronic instruments: only this severe and accurate control of these parameters guarantees decorative characteristics (brightness, colour) that last in time and high mechanical characteristics (adhesion, hardness).

Last in time

PVD treatment is, in the current state of the art, the surface granting the greatest resistance to atmospheric attacks. The salt spray tests carried out on our products in accordance with the European Standard UNI EN 1906: 2012 (and even more specifically in accordance with EN 1670 as described in 4.1.7) reached grade 5, which represents the highest achievable grade and which determines the extremely high corrosion resistance. The test was also performed at our internal laboratories using the methods of and in accordance with the UNI ISO 9227 (ITO-V-002) standard, which certifies its actual resistance to 1,500 hours in salt spray. This allows to guarantee on PVD-treated products a greater duration in time far superior to galvanic treatment or lacquered products.

Quality Certificate

It is hereby certified that the treatment of the surface of all the finishes is subject to strict internal controls according to the Operating Technical Instructions and process controls.

This treatment has passed the following tests:

- Resistance to salt spray according to standard UNI ISO 9227 (ITO-V-002)
- Thermal shock according to standard UNI ISO 2819 (ITO-V-003)
- Cross cut according to standard UNI ISO 2409 (ITO-V-008)
- Outdoor exposure (ITO-V-014)
- Lightfastness without alterations according to standard UNI ISO 9397 (ITO-V-013)

For cleaning we advise using a cloth dampened with alcohol.

* We disclaim all responsibility if there is negligent or inappropriate use of products.

The door handle and its accessories, which have become part of the furnishing of the home, are subject to daily use, and consequently to natural wear and tear. In addition, certain climatic conditions, or atmospheric agents such as salt-air or high humidity, or use in detrimental conditions can accelerate the ageing process, damaging the protective coating and causing corrosion with un-aesthetic results.

Thanks to the Zirtanio treatment, applied to the surface of the products, Assa Abloy Italia guarantees protection.

This finish is applied on request. For any further information or explanation you may require, please feel free to contact our offices.

Rosetta fine (50 x 5 mm) applicabile alle serie descritte: | (50 x 5 mm) slim rosette applicable to the following series:

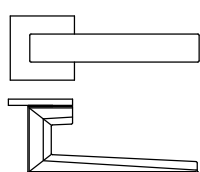

H 1068
Serie **Moon**
pag.18

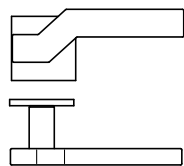

H 1066
Serie **Zeus**
pag.22

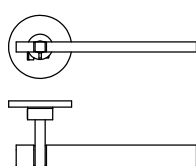

H 1065
Serie **Naked Due**
pag.24

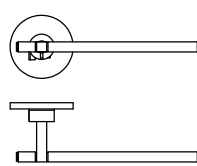

H 1064
Serie **Naked**
pag.26

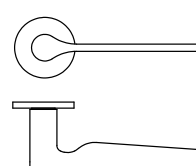

H 1062
Serie **Carmen**
pag.28

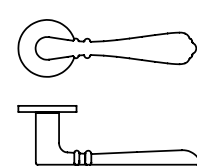

H 1061
Serie **Generentola**
pag.30

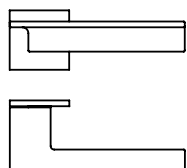

H 1060
Serie **Alina**
pag.32

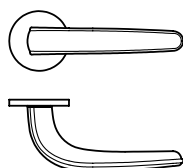

H 1058
Serie **Amica**
pag.34

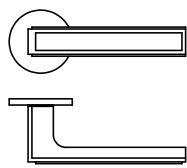

H 1056 T
Serie **Quadra**
pag.38

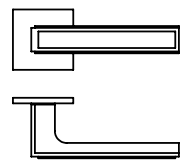

H 1056
Serie **Quadra**
pag.40

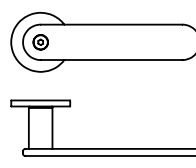

H 1055
Serie **Words**
pag.42

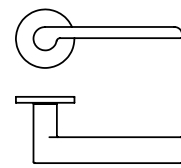

H 1054
Serie **W.W.**
pag.44

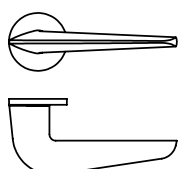

H 1052
Serie **Supersonic**
pag.46

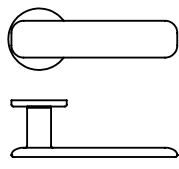

H 1050
Serie **Giasone**
pag.48

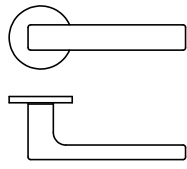

H 1049 T
Serie **Divara**
pag.50

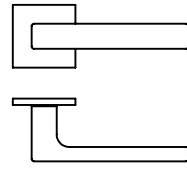

H 1049
Serie **Divara**
pag.52

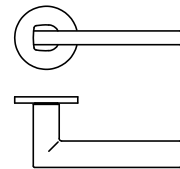

H 1046 T
Serie **Nais**
pag.54

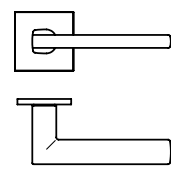

H 1046
Serie **Nais**
pag.56

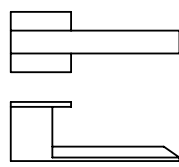

H 1045
Serie **Bess**
pag.58

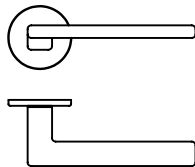

H 1044
Serie **Oberon**
pag.60

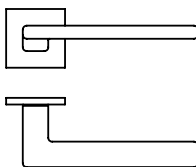

H 1044 Q
Serie **Oberon**
pag.64

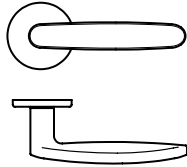

H 1043
Serie **Alcina**
pag.68

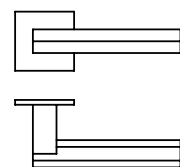

H 1040
Serie **Siberia**
pag.70

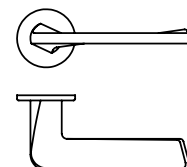

H 1039
Serie **Fedra**
pag.72

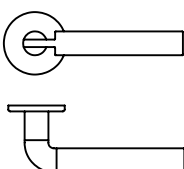

H 1026
Serie **Dido**
pag.80

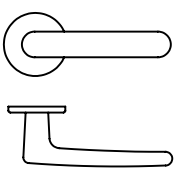

H 1024
Serie **Lolita**
pag.82

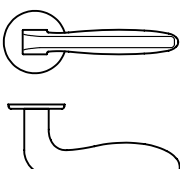

H 1022
Serie **Ernani**
pag.84

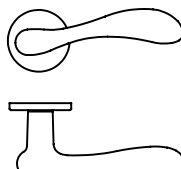

H 1003
Serie **Croco**
pag.92

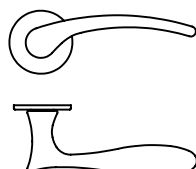

H 198
Serie **Mizar**
pag.96

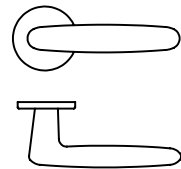

H 192
Serie **Prunus**
pag.98

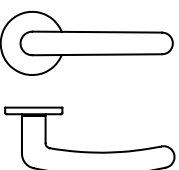

H 163
Serie **Sarissa**
pag.104



H 1068
Serie **Moon**
pag.18



H 1067
Serie **Rose**
pag.20



H 1066
Serie **Zeus**
pag.22



H 1065
Serie **Naked Due**
pag.24



H 1064
Serie **Naked**
pag.26



H 1062
Serie **Carmen**
pag.28



H 1061
Serie **Cenerentola**
pag.30



H 1060
Serie **Alina**
pag.32



H 1058
Serie **Amica**
pag.34



H 1057
Serie **Retrò**
pag.36



H 1056 T
Serie **Quadra**
pag.38



H 1056
Serie **Quadra**
pag.40



H 1055
Serie **Words**
pag.42



H 1054
Serie **W.W.**
pag.44



H 1052
Serie **Supersonic**
pag.46



H 1050
Serie **Giasone**
pag.48



H 1049 T
Serie **Divara**
pag.50



H 1049
Serie **Divara**
pag.52



H 1046 T
Serie **Nais**
pag.54



H 1046
Serie **Nais**
pag.56



H 1045
Serie **Bess**
pag.58



H 1044
Serie **Oberon**
pag.60



H 1044 U
Serie **Oberon**
pag.62



H 1044 Q
Serie **Oberon**
pag.64



H 1044 Q U
Serie **Oberon**
pag.66



H 1043
Serie **Alcina**
pag.68



H 1040
Serie **Siberia**
pag.70



H 1039
Serie **Fedra**
pag.72



H 1037
Serie **Teseo**
pag.74



H 1034
Serie **Polis**
pag.76



H 1027
Serie **Dafne**
pag.78



H 1026
Serie **Dido**
pag.80



H 1024
Serie **Lolita**
pag.82



H 1022
Serie **Ermani**
pag.84



H 1018
Serie **Otello**
pag.86



H 1016
Serie **Nabucco**
pag.88



H 1004
Serie **Antares**
pag.90



H 1003
Serie **Croco**
pag.92



H 914/8
Serie **Medicea**
pag.94



H 198
Serie **Mizar**
pag.96



H 192
Serie **Prunus**
pag.98



H 176
Serie **Spiga**
pag.100



H 165
Serie **Germana**
pag.102



H 163
Serie **Sarissa**
pag.104



H 123
Serie **Luigi XVI**
pag.106



H 419
Serie **Bordeaux**
pag.108



H 416
Serie **Garnet**
pag.110



H 414
Serie **Amber**
pag.112



Collezione V&V | *V&V Collection*



H 1068 Serie Moon

Materiale Ottone | Material Brass

design Pembroke & Ives

V&V Valli&Valli
ASSA ABLOY

Maniglia per porta | Door handle

Finiture | Finishes

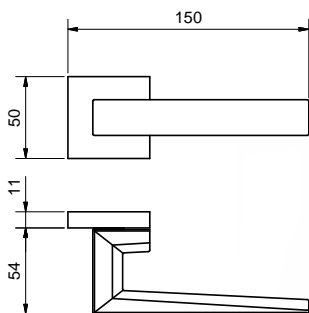

Cromo

Cromosat

Cromo/Cromosat



Disponibile anche in versione antincendio secondo normativa **Ö-NORM B 3859:2011**
Available also in the fire-proof version according **Ö-NORM B 3859:2011** standards



Disponibile anche **CLASSE 4 su R8 - RG8** secondo la norma **DIN EN 1906 - Digit 4 7 - 0 0 - 0 B**
Available also **CLASS 4 on R8 - RG8** according to the **DIN Standard EN 1906 - Digit 4 7 - 0 0 - 0 B**



K 1143 / K 1143 Y
Pag. 136



K 1225 RG6-7-8 50 BZG - 75
Pag. 152



K 1068 300 / 600
Pag. 124

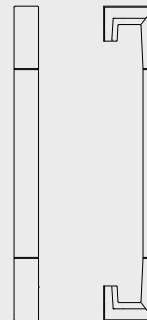

K 1143 CP / K 1143 CP Y
Pag. 136



K 1225 R6-7-8 50 BZG - 75
Pag. 155



In abbinamento sono disponibili | Coordinated accessories

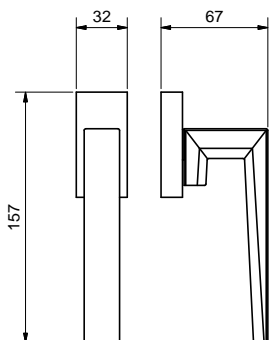

H 1068 FRS-41





H 1067 Serie Rose

Materiale Rame | Material Copper

design Valli Workshop

Valli&Valli
ASSA ABLOY

Maniglia per porta | Door handle

Finiture | Finishes

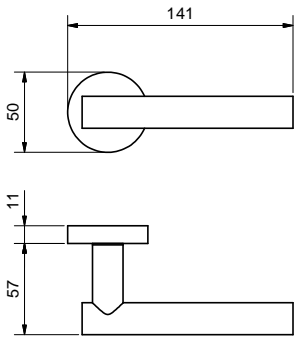

Metallo rame lucido

Metallo rame satinato



K 1197 / K 1197 Y
Pag. 134



K 1867 R6-7-8 50 BZG - 85
Pag. 150



K 1867 RS6-7-8 50 BZG - 85
Pag. 150



K 1067 300
Pag. 124

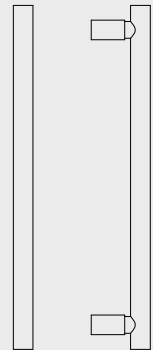

K 1067 R8 / K 1067 R8 Y
Pag. 119



In abbinamento sono disponibili | Coordinated accessories

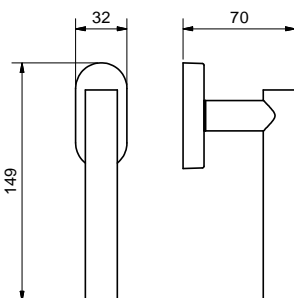

H 1067 FRS-41





H 1066 Serie Zeus

Materiale Ottone | Material Brass

design Bertone Design

Valli&Valli
ASSA ABLOY

Maniglia per porta | Door handle

Finiture | Finishes

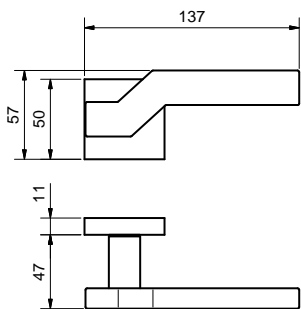

Orsatop

Cromosat

Nikelnero

Titanium - PVD



K 1143 / K 1143 Y
Pag. 136



K 1225 RG6-7-8 50 BZG - 75
Pag. 152



K 1066 300
Pag. 125

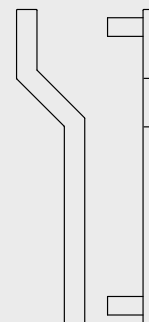

K 1143 CP / K 1143 CP Y
Pag. 136



K 1225 R6-7-8 50 BZG - 75
Pag. 155



In abbinamento sono disponibili | Coordinated accessories

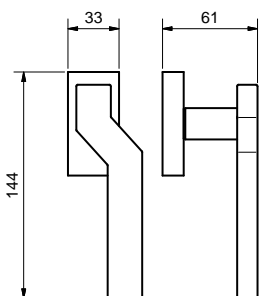

H 1066 FRS-41





H 1065 Serie Naked Due

Materiale Acciaio C40 + Ottone | Material Steel C40 + Brass

design Valli Workshop

Valli&Valli
ASSA ABLOY

Maniglia per porta | Door handle

Finiture | Finishes

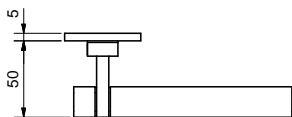
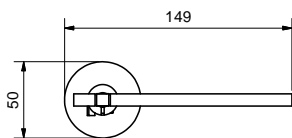

Cromo

Cromosat

Nikelnero



K 1121 B / K 1121 BY
Pag. 138



K 1865 R8 BZG
Pag. 150



In abbinamento sono disponibili | Coordinated accessories

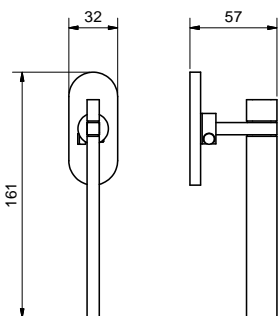

H 1065 FRS B-41





H 1064 Serie Naked

Materiale Acciaio C40 | Material Steel C40

design Valli Workshop

V&V Valli&Valli
ASSA ABLOY

Maniglia per porta | Door handle

Finiture | Finishes

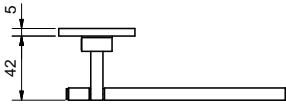
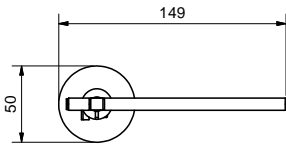

Cromosat

Neropaco

Biancopaco



K 1121 B / K 1121 BY
Pag. 138



K 1864 R8 50 BZG
Pag. 151



In abbinamento sono disponibili | Coordinated accessories

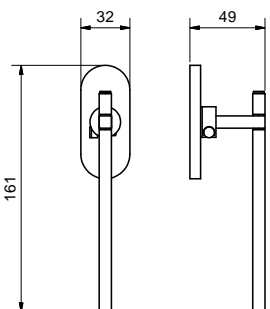

H 1064 FRS B-41





H 1062 Serie Carmen

Materiale Ottone | Material Brass

design Valli Workshop

Valli&Valli
ASSA ABLOY

Maniglia per porta | Door handle

Finiture | Finishes

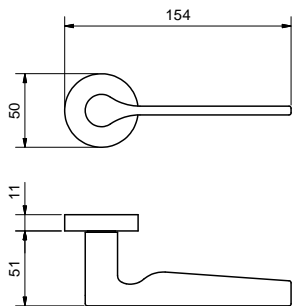

Cromosat

Bronzopaco

Nikelnero

Neropaco



Disponibile anche in versione antincendio secondo normativa Ö-NORM B 3859:2011
Available also in the fire-proof version according Ö-NORM B 3859:2011 standards



K 1121 / K 1121 Y
Pag. 138



K 1704 R6-7-8 50 BZG - 85
Pag. 153



K 1713 / K 1713 Y
Pag. 134



K 1704 RS6-7-8 50 BZG - 85
Pag. 154



K 1145 / K 1145 Y
Pag. 135



K 1123 RG6-7-8 BZG - 75
Pag. 152



In abbinamento sono disponibili | Coordinated accessories

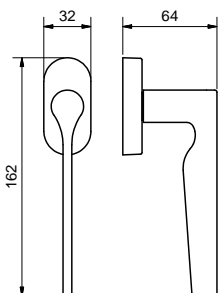

H 1062 FRS-41





H 1061 Serie Cenerentola

Materiale Ottone | Material Brass

design Luciana Di Virgilio
e Gianni Veneziano

V&V Valli&Valli
ASSA ABLOY

Maniglia per porta | Door handle

Finiture | Finishes

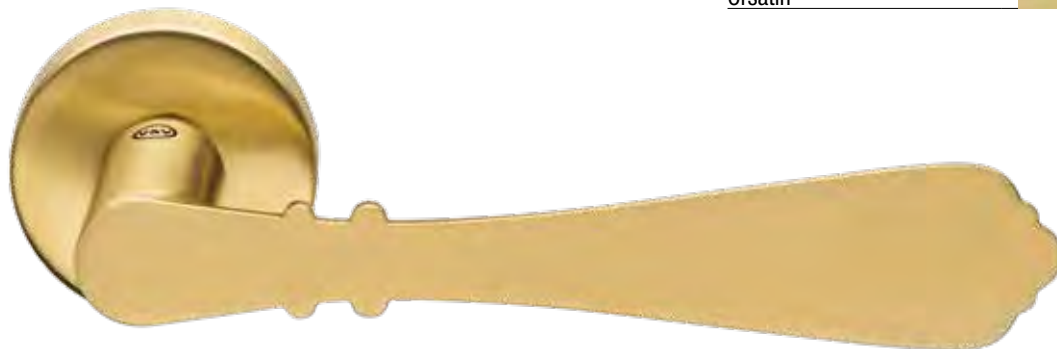
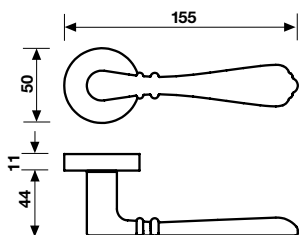

Bronzop

Light Black

Orsatin



Disponibile anche in versione antincendio secondo normativa Ö-NORM B 3859:2011
Available also in the fire-proof version according Ö-NORM B 3859:2011 standards



K 1121 / K 1121 Y
Pag. 138



K 1713 / K 1713 Y
Pag. 134



K 1145 / K 1145 Y
Pag. 135



K 1061 R8 / K 1061 R8 Y
Pag. 120



K 1704 R6-7-8 50 BZG - 85
Pag. 153



K 1704 RS6-7-8 50 BZG - 85
Pag. 154



K 1123 RG6-7-8 BZG - 75
Pag. 152



K 1061 300
Pag. 125

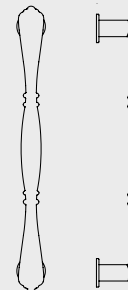

In abbinamento sono disponibili | Coordinated accessories

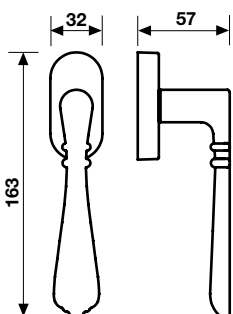

H 1061 FRS-41





H 1060 Serie Alina

Materiale Ottone | Material Brass

design Skidmore
Owings & Merrill

V&V Valli&Valli
ASSA ABLOY

Maniglia per porta | Door handle

Finiture | Finishes

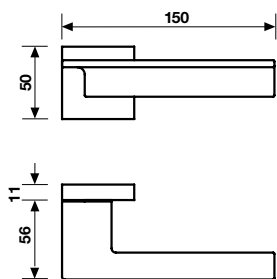

Cromosat

Cromo

Neropaco



Disponibile anche in versione antincendio secondo normativa **Ö-NORM B 3859:2011**
Available also in the fire-proof version according **Ö-NORM B 3859:2011** standards



Solo per materiale ottone disponibile anche **CLASSE 4 su R8 - RG8** secondo la norma **DIN EN 1906 - Digit 4 7 - 0 0 - 0 B**
Only for models in brass available also **CLASS 4 on R8 - RG8** according to the **DIN Standard EN 1906 - Digit 4 7 - 0 0 - 0 B**



K 1143 / K 1143 Y
Pag. 136



K 1225 RG6-7-8 50 BZG - 75
Pag. 152



K 1060 300 / 600
Pag. 126

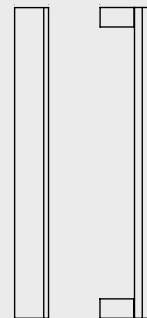

K 1143 CP / K 1143 CP Y
Pag. 136



K 1225 R6-7-8 50 BZG - 75
Pag. 155



K 1060 R8 / K 1060 R8 Y
Pag. 120



In abbinamento sono disponibili | Coordinated accessories

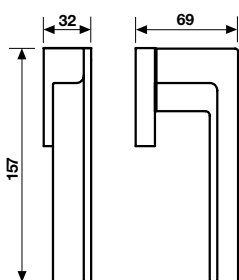

H 1060 FRS-41





H 1058 Serie Amica

design Valli Workshop

Valli&Valli
ASSA ABLOY

Materiale Nikrall Lega Zama UNI 3717 | Material Nikrall Lega Zama UNI 3717

Maniglia per porta | Door handle

Finiture | Finishes

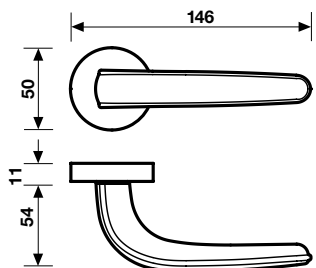

Cromo/Cromosat

Nikelnero

Biancopaco



K 1121 / K 1121 Y
Pag. 138



K 1704 R6-7-8 50 BZG - 85
Pag. 153



K 1713 / K 1713 Y
Pag. 134



K 1704 RS6-7-8 50 BZG - 85
Pag. 154



K 1145 / K 1145 Y
Pag. 135



K 1123 RG6-7-8 BZG - 75
Pag. 152



In abbinamento sono disponibili | Coordinated accessories

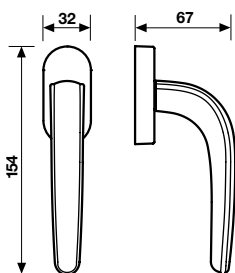

H 1058 FRS-41

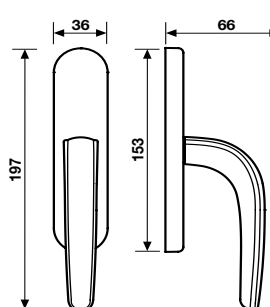

H 1058 F





H 1057 Serie Retrò

Materiale Ottone | Material Brass

design Valli Workshop

Valli&Valli
ASSA ABLOY

Maniglia per porta | Door handle

Finiture | Finishes

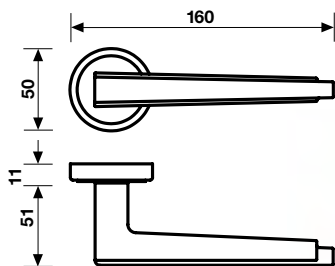

Cromo

Orolucido

Bronzop



Disponibile anche in versione antincendio secondo normativa Ö-NORM B 3859:2011
Available also in the fire-proof version according Ö-NORM B 3859:2011 standards



Solo per materiale ottone disponibile anche CLASSE 4 su R8 - RG8 secondo la norma DIN EN 1906 - Digit 4 7 - 0 0 - 0 B
Only for models in brass available also CLASS 4 on R8 - RG8 according to the DIN Standard EN 1906 - Digit 4 7 - 0 0 - 0 B

K 1122 / K 1122 Y
Pag. 137



K 1704 R6-7-8 50 BZG - 85
Pag. 153



K 1755 / K 1755 Y
Pag. 134



K 1704 RS6-7-8 50 BZG - 85
Pag. 154



K 1145 / K 1145 Y
Pag. 135



In abbinamento sono disponibili | Coordinated accessories

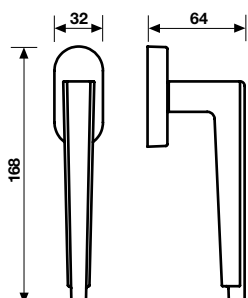

H 1057 FRS-41





H 1056 T Serie Quadra

design Valli Workshop

Valli&Valli
ASSA ABLOY

Materiale Nikrall Lega Zama UNI 3717 | Material Nikrall Lega Zama UNI 3717

Maniglia per porta | Door handle

Finiture | Finishes

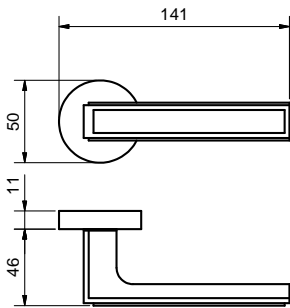

Cromo

Nikelnero

Neropaco



K 1121 / K 1121 Y
Pag. 138



K 1145 / K 1145 Y
Pag. 135



K 1704 R6-7-8 50 BZG - 85
Pag. 153



K 1704 RS6-7-8 50 BZG - 85
Pag. 154



K 1123 RG6-7-8 BZG - 75
Pag. 152



K 1056 300 / 600
Pag. 126

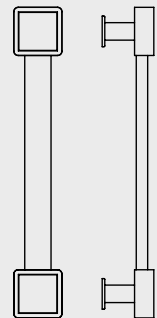

K 1056 T R8 / K 1056 T R8 Y
Pag. 120



In abbinamento sono disponibili | Coordinated accessories

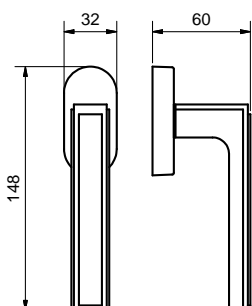

H 1056 T FRS-41





H 1056 Serie Quadra

Materiale Nikrall Lega Zama UNI 3717 | Material Nikrall Lega Zama UNI 3717

design Valli Workshop

Valli&Valli
ASSA ABLOY

Maniglia per porta | Door handle

Finiture | Finishes

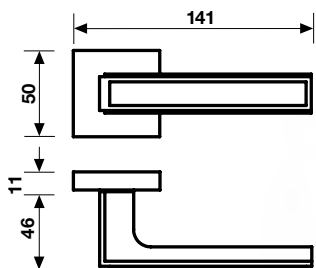

Cromo

Nikelnero

Neropaco



K 1143 / K 1143 Y
Pag. 136



K 1143 CP / K 1143 CP Y
Pag. 136



K 1148 / K 1148 Y
Pag. 135



K 1056 R8 / K 1056 R8 Y
Pag. 121



K 1225 R6-7-8 50 BZG - 75
Pag. 155



K 1225 RG6-7-8 50 BZG - 75
Pag. 152



K 1056 300 / 600
Pag. 126

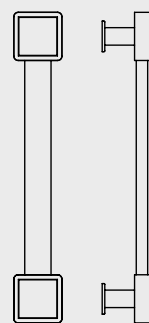

In abbinamento sono disponibili | Coordinated accessories

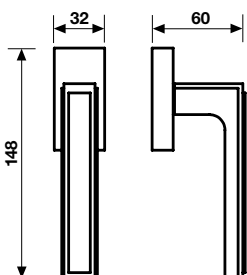

H 1056 FRS-41





H 1055 Serie Words

Materiale Ottone/Alluminio | Material Brass/Aluminium

design Franco Poli

V&V Valli&Valli
ASSA ABLOY

Maniglia per porta | Door handle

Finiture | Finishes

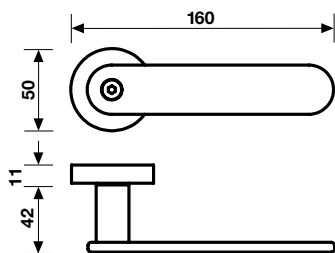

Cromo/Neropaco

Cromosat/Neropaco



K 1121 / K 1121 Y
Pag. 138



K 1704 R6-7-8 50 BZG - 85
Pag. 153



K 1055 300 / 600
Pag. 127

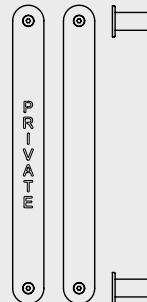

K 1713 / K 1713 Y
Pag. 134



K 1704 RS6-7-8 50 BZG - 85
Pag. 154



K 1145 / K 1145 Y
Pag. 135



K 1123 RG6-7-8 BZG - 75
Pag. 152



K 1055 R8 / K 1055 R8 Y
Pag. 121



In abbinamento sono disponibili | Coordinated accessories

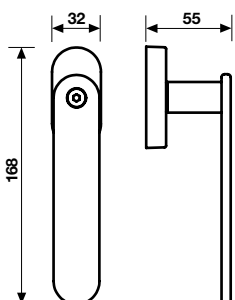

H 1055 FRS-41





H 1054 Serie W.W.

Materiale Ottone | Material Brass

design Valli Workshop

Valli&Valli
ASSA ABLOY

Maniglia per porta | Door handle **Finiture | Finishes**

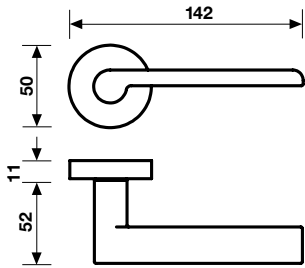

- Cromo
- Nikmatt
- Orsatop
- Ramematt



Disponibile anche in versione antincendio secondo normativa Ö-NORM B 3859:2011
Available also in the fire-proof version according Ö-NORM B 3859:2011 standards



Disponibile anche CLASSE 4 su R8 - RG8 secondo la norma DIN EN 1906 - Digit 4 7 - 0 0 - 0 B
Available also CLASS 4 on R8 - RG8 according to the DIN Standard EN 1906 - Digit 4 7 - 0 0 - 0 B



K 1121 / K 1121 Y
Pag. 138



K 1704 R6-7-8 50 BZG - 85
Pag. 153



K 1054 300 / 600
Pag. 127

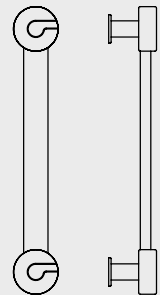

K 1713 / K 1713 Y
Pag. 134



K 1704 RS6-7-8 50 BZG - 85
Pag. 154



K 1145 / K 1145 Y
Pag. 135



K 1123 RG6-7-8 BZG - 75
Pag. 152

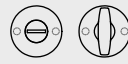

K 1054 R8 / K 1054 R8 Y
Pag. 121



In abbinamento sono disponibili | Coordinated accessories

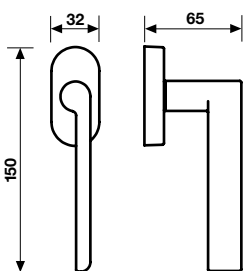

H 1054 FRS-41

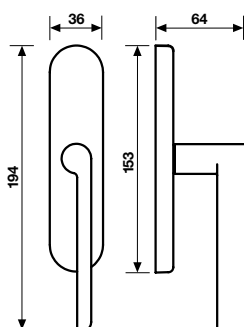

H 1054 F





H 1052 Serie Supersonic

Materiale Ottone | Material Brass

design Mikhail Leykin

Valli&Valli
ASSA ABLOY

Maniglia per porta | Door handle

Finiture | Finishes

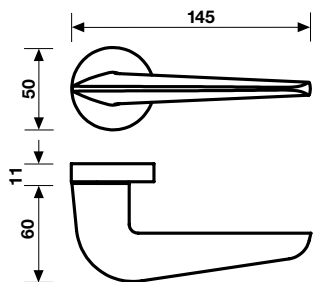

Cromo

Cromosat

Bronzop

Neropaco

Biancopaco



Disponibile anche in versione antincendio secondo normativa Ö-NORM B 3859:2011
Available also in the fire-proof version according Ö-NORM B 3859:2011 standards



Disponibile anche CLASSE 4 su R8 - RG8 secondo la norma DIN EN 1906 - Digit 4 7 - 0 0 - 0 B
Available also CLASS 4 on R8 - RG8 according to the DIN Standard EN 1906 - Digit 4 7 - 0 0 - 0 B



Certificazione GOST di conformità e resistenza al fuoco
GOST Certificate of Conformity and fire resistance



K 1121 / K 1121 Y
Pag. 138

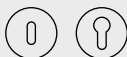

K 1704 R6-7-8 50 BZG - 85
Pag. 153



K 1713 / K 1713 Y
Pag. 134



K 1704 RS6-7-8 50 BZG - 85
Pag. 154



K 1123 RG6-7-8 BZG - 75
Pag. 152



In abbinamento sono disponibili | Coordinated accessories

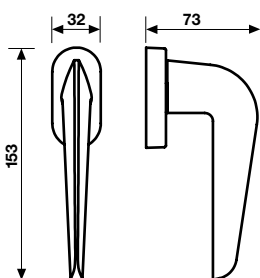

H 1052 FRS-41

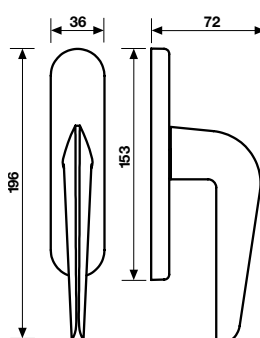

H 1052 F





H 1050 Serie Giasone

Materiale Ottone | Material Brass

design Valli Workshop

Valli&Valli
ASSA ABLOY

Maniglia per porta | Door handle

Finiture | Finishes

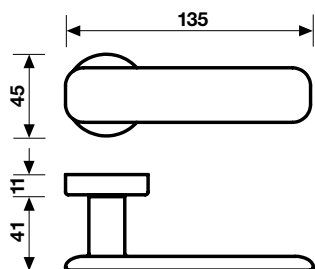

Cromo

Cromosat

Orsatin



Disponibile anche in versione antincendio secondo normativa Ö-NORM B 3859:2011
Available also in the fire-proof version according Ö-NORM B 3859:2011 standards



Disponibile anche CLASSE 4 su R8 - RG8 secondo la norma DIN EN 1906 - Digit 4 7 - 0 0 - 0 B
Available also CLASS 4 on R8 - RG8 according to the DIN Standard EN 1906 - Digit 4 7 - 0 0 - 0 B



K 1121 / K 1121 Y
Pag. 138



K 1704 R6-7-8 50 BZG - 85
Pag. 153



K 1713 / K 1713 Y
Pag. 134



K 1704 RS6-7-8 50 BZG - 85
Pag. 154



K 1145 / K 1145 Y
Pag. 135



K 1123 RG6-7-8 BZG - 75
Pag. 152



K 1168 R8 / K 1168 R8 Y
Pag. 117

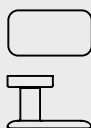

In abbinamento sono disponibili | Coordinated accessories

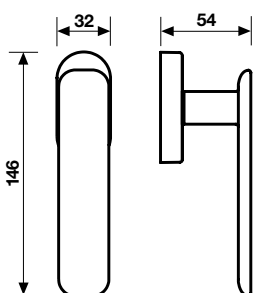

H 1050 FRS-41





H 1049 T Serie Divara

Materiale Ottone | Material Brass

design Valli Workshop

Valli&Valli
ASSA ABLOY

Maniglia per porta | Door handle **Finiture | Finishes**

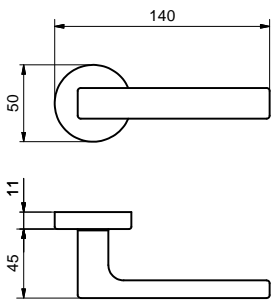

- Cromo
- Cromosat
- Light Black
- Neropaco



Disponibile anche in versione antincendio secondo normativa Ö-NORM B 3859:2011
Available also in the fire-proof version according to Ö-NORM B 3859:2011 standards



Disponibile anche CLASSE 4 su R8 - RG8 secondo la norma DIN EN 1906 - Digit 4 7 - 0 0 - 0 B
Available also CLASS 4 on R8 - RG8 according to the DIN Standard EN 1906 - Digit 4 7 - 0 0 - 0 B



K 1121 / K 1121 Y
Pag. 138



K 1704 R6-7-8 50 BZG - 85
Pag. 153



K 1145 / K 1145 Y
Pag. 135



K 1704 RS6-7-8 50 BZG - 85
Pag. 154



K 1123 RG6-7-8 BZG - 75
Pag. 152



In abbinamento sono disponibili | Coordinated accessories

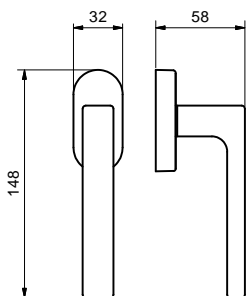

H 1049 T FRS-41





H 1049 Serie Divara

Materiale Ottone | Material Brass

design Valli Workshop

Valli&Valli
ASSA ABLOY

Maniglia per porta | Door handle

Finiture | Finishes

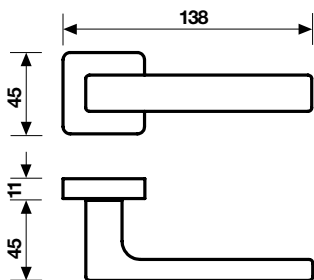

Cromo

Cromosat

Light Black

Neropaco



Disponibile anche in versione antincendio secondo normativa Ö-NORM B 3859:2011
Available also in the fire-proof version according Ö-NORM B 3859:2011 standards



Disponibile anche CLASSE 4 su R8 - RG8 secondo la norma DIN EN 1906 - Digit 4 7 - 0 0 - 0 B
Available also CLASS 4 on R8 - RG8 according to the DIN Standard EN 1906 - Digit 4 7 - 0 0 - 0 B



K 1142 / K 1142 Y
Pag. 136



K 1233 R6-7-8 BZG - 85
Pag. 155



K 1144 CP / K 1144 CP Y
Pag. 135



K 1233 RS6-7-8 BZG - 85
Pag. 155



K 1148 / K 1148 Y
Pag. 135



K 1229 RG6-7-8 BZG - 75
Pag. 151

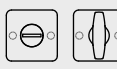

In abbinamento sono disponibili | Coordinated accessories

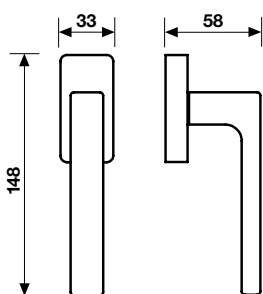

H 1049 FRS-41





H 1046 T Serie Nais

Materiale Ottone | Material Brass

design Valli Workshop

Valli&Valli
ASSA ABLOY

Maniglia per porta | Door handle **Finiture | Finishes**

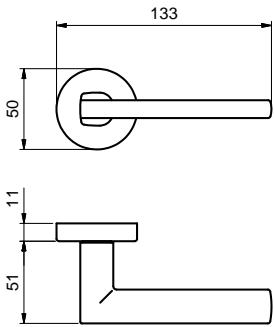

- Cromo
- Cromosat
- Neropaco



Disponibile anche in versione antincendio secondo normativa **Ö-NORM B 3859:2011**
Available also in the fire-proof version according **Ö-NORM B 3859:2011** standards



Disponibile anche **CLASSE 4 su R8 - RG8** secondo la norma **DIN EN 1906 - Digit 4 7 - 0 0 - 0 B**
Available also **CLASS 4 on R8 - RG8** according to the **DIN Standard EN 1906 - Digit 4 7 - 0 0 - 0 B**



K 1121 / K 1121 Y
Pag. 138



K 1704 R6-7-8 50 BZG - 85
Pag. 153



K 1145 / K 1145 Y
Pag. 135



K 1704 RS6-7-8 50 BZG - 85
Pag. 154



K 1123 RG6-7-8 BZG - 75
Pag. 152



In abbinamento sono disponibili | Coordinated accessories

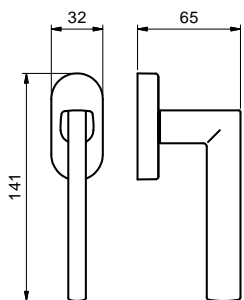

H 1046 T FRS-41

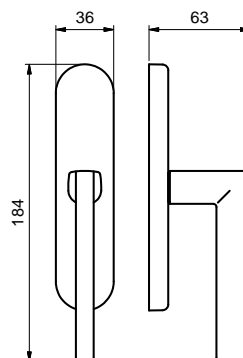

H 1046 T F



H 1046 Serie Nais

Materiale Ottone | Material Brass

design Valli Workshop

Valli&Valli
ASSA ABLOY

Maniglia per porta | Door handle **Finiture | Finishes**

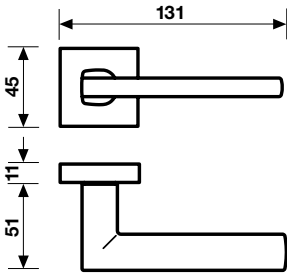

- Cromo
- Cromosat
- Neropaco



Disponibile anche in versione antincendio secondo normativa Ö-NORM B 3859:2011
Available also in the fire-proof version according Ö-NORM B 3859:2011 standards



Disponibile anche CLASSE 4 su R8 - RG8 secondo la norma DIN EN 1906 - Digit 4 7 - 0 0 - 0 B
Available also CLASS 4 on R8 - RG8 according to the DIN Standard EN 1906 - Digit 4 7 - 0 0 - 0 B



K 1139 / K 1139 Y
Pag. 137



K 1740 R6-7-8 BZG - 85
Pag. 153



K 1143 CP / K 1143 CP Y
Pag. 136



K 1225 RG6-7-8 BZG - 75
Pag. 152



K 1148 / K 1148 Y
Pag. 135



In abbinamento sono disponibili | Coordinated accessories

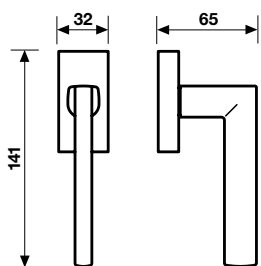

H 1046 FRS-41

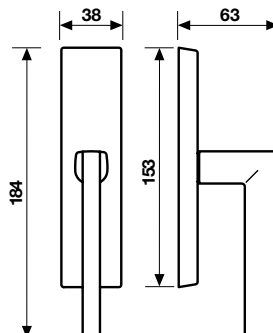

H 1046 F





H 1045 Serie Bess

design Yoshimi Kono

Valli&Valli
ASSA ABLOY

Materiale Nikrall Lega Zama UNI 3717 | Material Nikrall Lega Zama UNI 3717

Maniglia per porta | Door handle

Finiture | Finishes

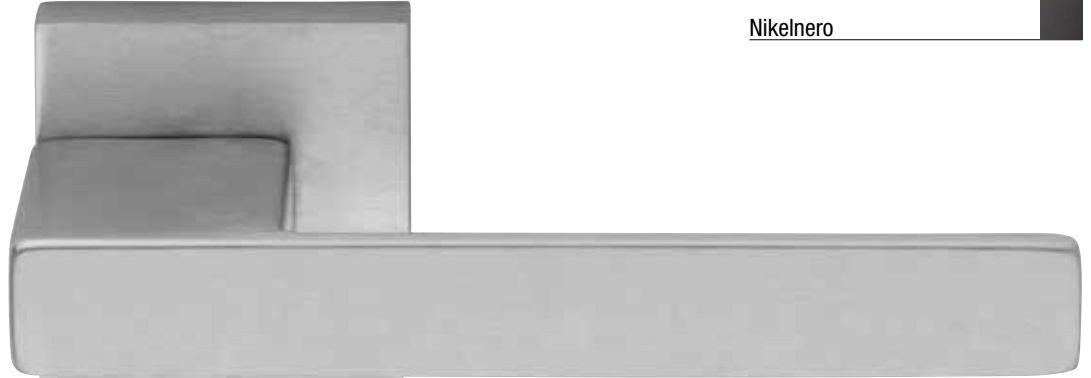
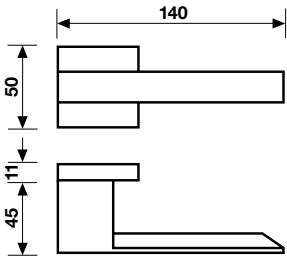

- Cromo
- Cromosat
- Cromosat/Cromo
- Nikelnero



Disponibile anche in versione antincendio secondo normativa Ö-NORM B 3859:2011
Available also in the fire-proof version according Ö-NORM B 3859:2011 standards



Disponibile anche CLASSE 4 su R8 - RG8 secondo la norma DIN EN 1906 - Digit 4 7 - 0 0 - 0 B
Available also CLASS 4 on R8 - RG8 according to the DIN Standard EN 1906 - Digit 4 7 - 0 0 - 0 B



K 1143 / K 1143 Y
Pag. 136



K 1225 RG6-7-8 50 BZG - 75
Pag. 152

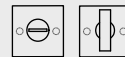

K 1228
Pag. 128

K 169
Pag. 131

K 1143 CP / K 1143 CP Y
Pag. 136



K 1230
Pag. 142



K 1225 R6-7-8 50 BZG - 75
Pag. 155



K 1232
Pag. 142

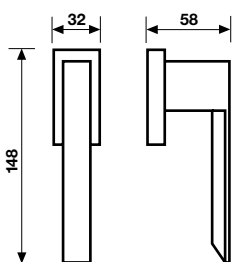
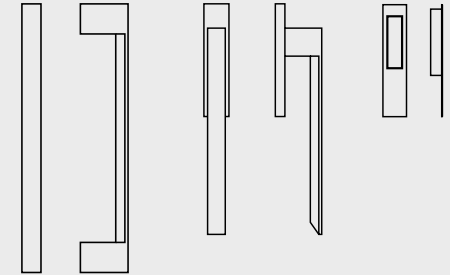

H 1045 FRS-41

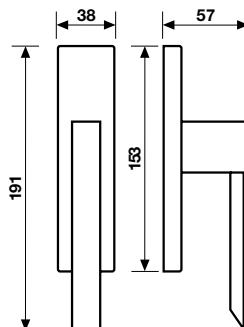

H 1045 F





H 1044 Serie Oberon

design Vincent Van Duysen

Valli&Valli
ASSA ABLOY

Materiale Nikral® Lega Zama UNI 3717 | Material Nikral® Lega Zama UNI 3717

Maniglia per porta | Door handle

Finiture | Finishes

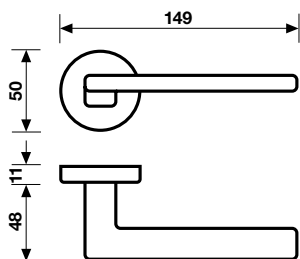

Cromo

Cromosat

Neropaco



K 1121 / K 1121 Y
Pag. 138



K 1704 R6-7-8 50 BZG - 85
Pag. 153



K 1713 / K 1713 Y
Pag. 134



K 1704 RS6-7-8 50 BZG - 85
Pag. 154



K 1145 / K 1145 Y
Pag. 135



K 1123 RG6-7-8 BZG - 75
Pag. 152



In abbinamento sono disponibili | Coordinated accessories

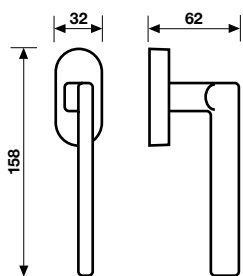

H 1044 FRS-41

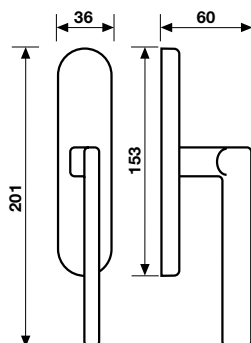

H 1044 F





H 1044 U Serie Oberon

Materiale Ottone | Material Brass

design Vincent Van Duysen

Valli&Valli
ASSA ABLOY

Maniglia per porta | Door handle

Finiture | Finishes

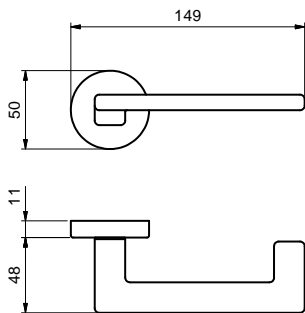

Cromo

Cromosat

Neropaco



Disponibile anche in versione antincendio secondo normativa **Ö-NORM B 3859:2011**

Available also in the fire-proof version according **Ö-NORM B 3859:2011 standards**



Disponibile anche **CLASSE 4 su R8 - RG8 secondo la norma DIN EN 1906 - Digit 4 7 - 0 0 - 0 B**

Available also **CLASS 4 on R8 - RG8 according to the DIN Standard EN 1906 - Digit 4 7 - 0 0 - 0 B**

K 1121 / K 1121 Y
Pag. 138



K 1145 / K 1145 Y
Pag. 135



K 1704 R6-7-8 50 BZG - 85
Pag. 153



K 1704 RS6-7-8 50 BZG - 85
Pag. 154

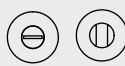

K 1123 RG6-7-8 BZG - 75
Pag. 152





H 1044 Q Serie Oberon

design Vincent Van Duysen

V&V **Valli&Valli**
ASSA ABLOY

Materiale Nikral® Lega Zama UNI 3717 | Material Nikral® Lega Zama UNI 3717

Maniglia per porta | Door handle **Finiture | Finishes**

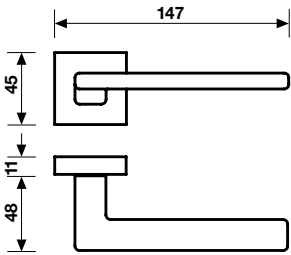

- Cromo
- Cromosat
- Neropaco



K 1139 / K 1139 Y
Pag. 137



K 1740 R6-7-8 BZG - 85
Pag. 153



K 1143 CP / K 1143 CP Y
Pag. 136



K 1225 RG6-7-8 BZG - 75
Pag. 152



K 1148 / K 1148 Y
Pag. 135



In abbinamento sono disponibili | Coordinated accessories

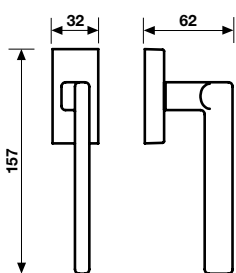

H 1044 FRS-Q-41

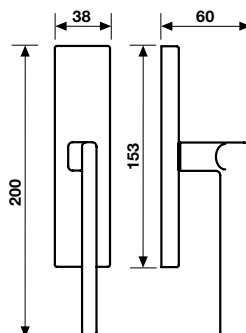

H 1044 F Q





H 1044 Q U Serie Oberon

Materiale Ottone | Material Brass

design Vincent Van Duysen

V&V **Valli&Valli**
ASSA ABLOY

Maniglia per porta | Door handle

Finiture | Finishes

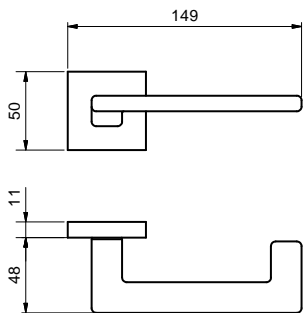

Cromo

Cromosat

Neropaco



Disponibile anche in versione antincendio secondo normativa Ö-NORM B 3859:2011
Available also in the fire-proof version according Ö-NORM B 3859:2011 standards



Disponibile anche CLASSE 4 su R8 - RG8 secondo la norma DIN EN 1906 - Digit 4 7 - 0 0 - 0 B
Available also CLASS 4 on R8 - RG8 according to the DIN Standard EN 1906 - Digit 4 7 - 0 0 - 0 B

K 1139 / K 1139 Y
Pag. 137



K 1740 R6-7-8 BZG - 85
Pag. 153



K 1143 CP / K 1143 CP Y
Pag. 136



K 1225 RG6-7-8 BZG - 75
Pag. 152



K 1148 / K 1148 Y
Pag. 135





H 1043 Serie Alcina

Materiale Nikrall Lega Zama UNI 3717 | Material Nikrall Lega Zama UNI 3717

design Matteo Thun

Valli&Valli
ASSA ABLOY

Maniglia per porta | Door handle

Finiture | Finishes

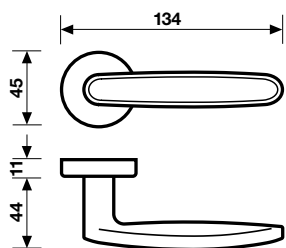

Orolux/Orsatin

Cromo/Cromosat



K 1121 / K 1121 Y
Pag. 138



K 1704 R6-7-8 50 BZG - 85
Pag. 153



K 1713 / K 1713 Y
Pag. 134



K 1704 RS6-7-8 50 BZG - 85
Pag. 154



K 1145 / K 1145 Y
Pag. 135



K 1123 RG6-7-8 BZG - 75
Pag. 152



In abbinamento sono disponibili | Coordinated accessories

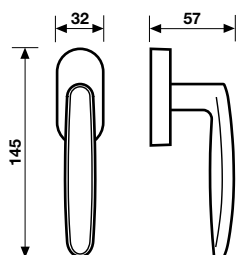

H 1043 FRS-41

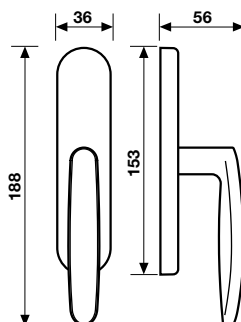

H 1043 F





H 1040 Serie Siberia

Materiale Ottone | Material Brass

design Gabriele e Oscar Buratti

Valli&Valli
ASSA ABLOY

Maniglia per porta | Door handle

Finiture | Finishes

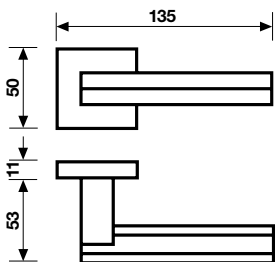

Cromo

Cromosat

Bronzsat



Disponibile anche in versione antincendio secondo normativa Ö-NORM B 3859:2011
Available also in the fire-proof version according Ö-NORM B 3859:2011 standards



K 1143 / K 1143 Y
Pag. 136



K 1225 R6-7-8 BZG - 85
Pag. 155



K 1143 CP / K 1143 CP Y
Pag. 136



K 1225 RG6-7-8 BZG - 75
Pag. 152

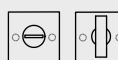

K 1148 / K 1148 Y
Pag. 135



In abbinamento sono disponibili | Coordinated accessories

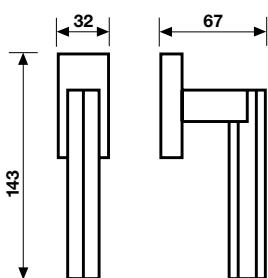

H 1040 FRS-41

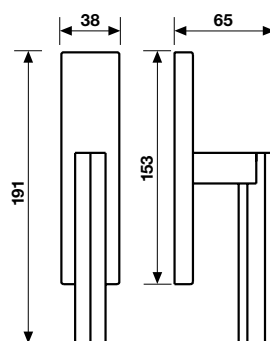

H 1040 F





H 1039 Serie Fedra

Materiale Ottone | Material Brass

design Jean-Baptiste Sibertin Blanc

Valli&Valli
ASSA ABLOY

Maniglia per porta | Door handle

Finiture | Finishes

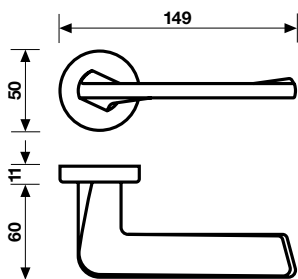

Orolucido

Cromo/Cromosat



Disponibile anche in versione antincendio secondo normativa Ö-NORM B 3859:2011
Available also in the fire-proof version according Ö-NORM B 3859:2011 standards



Disponibile anche CLASSE 4 su R8 - RG8 secondo la norma DIN EN 1906 - Digit 4 7 - 0 0 - 0 B
Available also CLASS 4 on R8 - RG8 according to the DIN Standard EN 1906 - Digit 4 7 - 0 0 - 0 B



K 1121 / K 1121 Y
Pag. 138



K 1704 R6-7-8 50 BZG - 85
Pag. 153



K 1226
Pag. 128

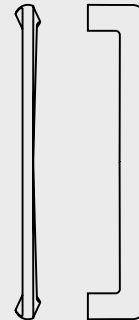

K 1713 / K 1713 Y
Pag. 134



K 1704 RS6-7-8 50 BZG - 85
Pag. 154



K 1145 / K 1145 Y
Pag. 135



K 1123 RG6-7-8 BZG - 75
Pag. 152



In abbinamento sono disponibili | Coordinated accessories

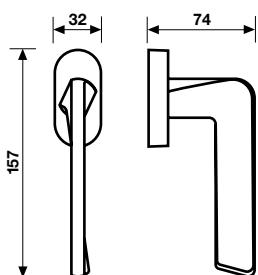

H 1039 FRS-41

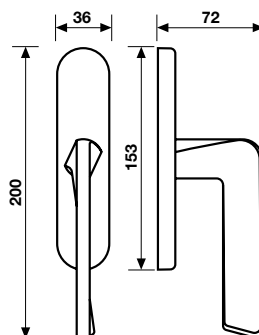

H 1039 F





H 1037 Serie Teseo

Materiale Ottone | Material Brass

design Valli Workshop

Valli&Valli
ASSA ABLOY

Maniglia per porta | Door handle

Finiture | Finishes

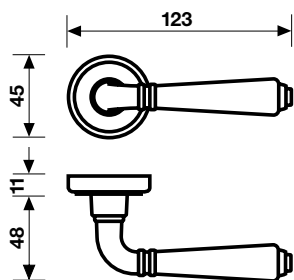

Orolucido

Ottone antico

Brunito



Disponibile anche in versione antincendio secondo normativa Ö-NORM B 3859:2011
Available also in the fire-proof version according Ö-NORM B 3859:2011 standards



K 1110 / K 1110 Y
Pag. 139



K 1704 R6-7-8 50 BZG - 85
Pag. 153



K 1755 / K 1755 Y
Pag. 134



K 1704 RS6-7-8 50 BZG - 85
Pag. 154



K 1145 / K 1145 Y
Pag. 135



K 1123 RG6-7-8 BZG - 75
Pag. 152



In abbinamento sono disponibili | Coordinated accessories

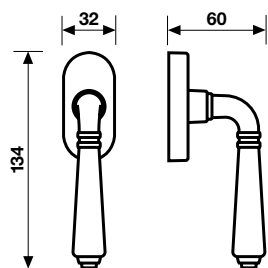

H 1037 FRS-41

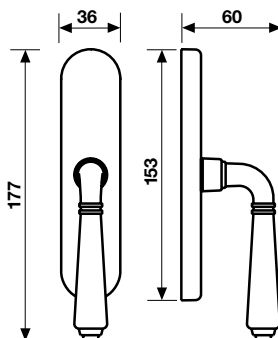

H 1037 F





H 1034 Serie Polis

design Dacoma Design

Valli&Valli
ASSA ABLOY

Materiale Nikrall Lega Zama UNI 3717 | Material Nikrall Lega Zama UNI 3717

Maniglia per porta | Door handle

Finiture | Finishes

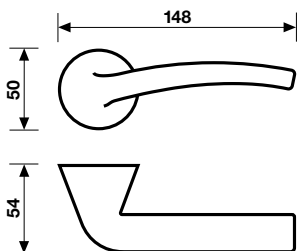

Cromo

Cromosat

K 1121 / K 1121 Y
Pag. 138



K 1704 R6-7-8 50 BZG - 85
Pag. 153



K 1713 / K 1713 Y
Pag. 134



K 1704 RS6-7-8 50 BZG - 85
Pag. 154



K 1123 RG6-7-8 BZG - 75
Pag. 152



In abbinamento sono disponibili | Coordinated accessories

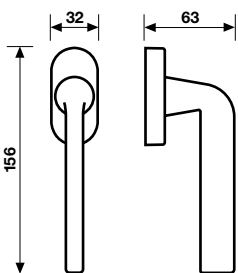

H 1034 FRS-41

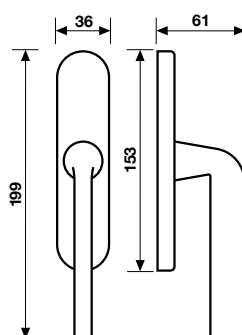

H 1034 F



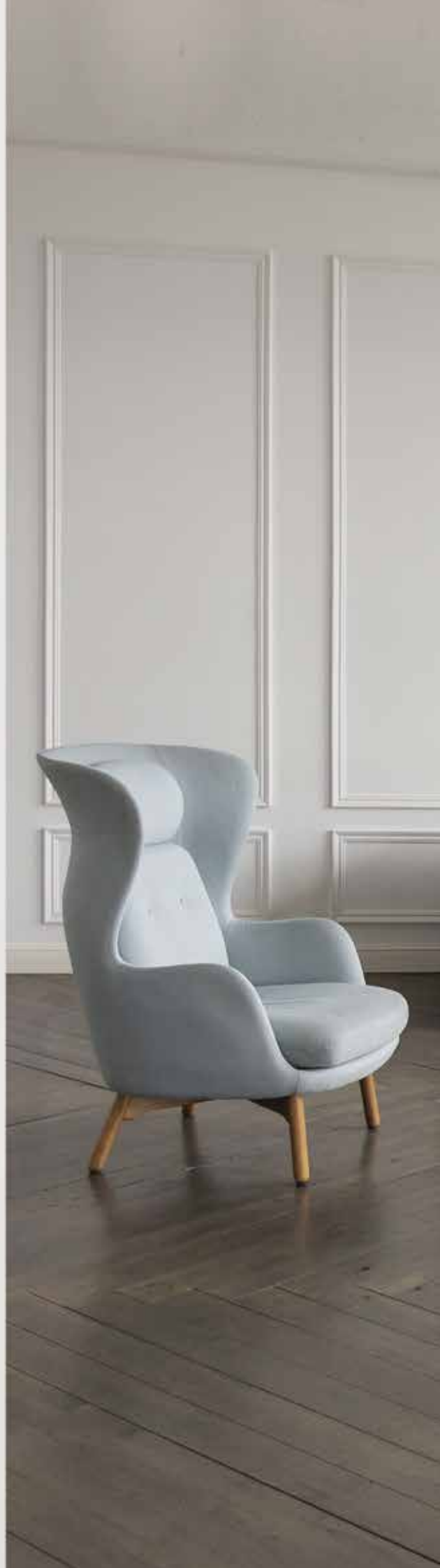

H 1027 Serie Dafne

Materiale Ottone | Material Brass

design Studio Carlesi Design

Valli&Valli
ASSA ABLOY

Maniglia per porta | Door handle

Finiture | Finishes

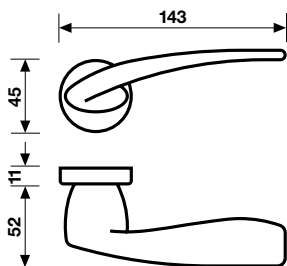

Orolucido

Cromosat



Disponibile anche in versione antincendio secondo normativa Ö-NORM B 3859:2011
Available also in the fire-proof version according Ö-NORM B 3859:2011 standards



Disponibile anche CLASSE 4 su R8 - RG8 secondo la norma DIN EN 1906 - Digit 4 7 - 0 0 - 0 B
Available also CLASS 4 on R8 - RG8 according to the DIN Standard EN 1906 - Digit 4 7 - 0 0 - 0 B

K 1112 / K 1112 Y
Pag. 138



K 1704 R6-7-8 50 BZG - 85
Pag. 153



K 1713 / K 1713 Y
Pag. 134



K 1704 RS6-7-8 50 BZG - 85
Pag. 154



K 1123 RG6-7-8 BZG - 75
Pag. 152



In abbinamento sono disponibili | Coordinated accessories

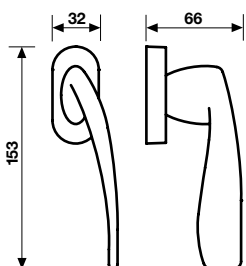

H 1027 FRS-41





H 1026 Serie Dido

Materiale Ottone | Material Brass

design Antonio Bullo

Valli&Valli
ASSA ABLOY

Maniglia per porta | Door handle

Finiture | Finishes

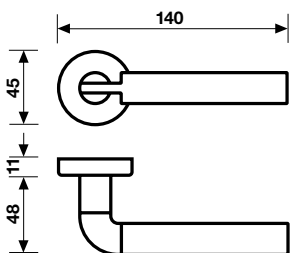

Orsatin/Orolucido

Cromo/Cromosat



Disponibile anche in versione antincendio secondo normativa Ö-NORM B 3859:2011
Available also in the fire-proof version according to Ö-NORM B 3859:2011 standards



Disponibile anche CLASSE 4 su R8 - RG8 secondo la norma DIN EN 1906 - Digit 4 7 - 0 0 - 0 B
Available also CLASS 4 on R8 - RG8 according to the DIN Standard EN 1906 - Digit 4 7 - 0 0 - 0 B



K 1112 / K 1112 Y
Pag. 138

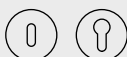

K 1704 R6-7-8 50 BZG - 85
Pag. 153



K 1713 / K 1713 Y
Pag. 134



K 1704 RS6-7-8 50 BZG - 85
Pag. 154



K 1145 / K 1145 Y
Pag. 135



K 1123 RG6-7-8 BZG - 75
Pag. 152



In abbinamento sono disponibili | Coordinated accessories

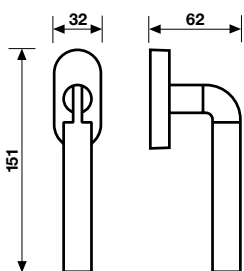

H 1026 FRS-41

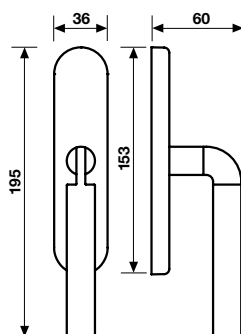

H 1026 F





H 1024 Serie Lolita

Materiale Ottone | Material Brass

design Valli Workshop

Valli&Valli
ASSA ABLOY

Maniglia per porta | Door handle **Finiture | Finishes**

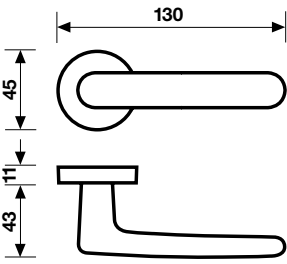

- Orolucido
- Cromo
- Cromosat



Disponibile anche in versione antincendio secondo normativa Ö-NORM B 3859:2011
Available also in the fire-proof version according Ö-NORM B 3859:2011 standards



Disponibile anche CLASSE 4 su R8 - RG8 secondo la norma DIN EN 1906 - Digit 4 7 - 0 0 - 0 B
Available also CLASS 4 on R8 - RG8 according to the DIN Standard EN 1906 - Digit 4 7 - 0 0 - 0 B



K 1112 / K 1112 Y
Pag. 138



K 1704 R6-7-8 50 BZG - 85
Pag. 153



K 1713 / K 1713 Y
Pag. 134



K 1704 RS6-7-8 50 BZG - 85
Pag. 154



K 1145 / K 1145 Y
Pag. 135



K 1123 RG6-7-8 BZG - 75
Pag. 152



In abbinamento sono disponibili | Coordinated accessories

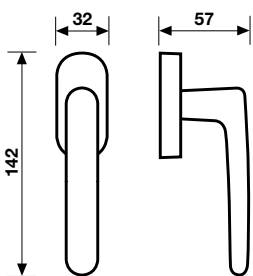

H 1024 FRS-41

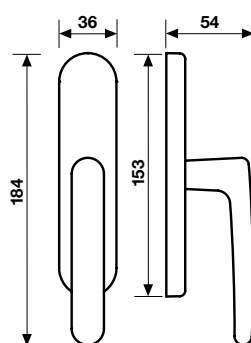

H 1024 F





H 1022 Serie Ernani

Materiale Ottone | Material Brass

design Valli Workshop

Valli&Valli
ASSA ABLOY

Maniglia per porta | Door handle

Finiture | Finishes

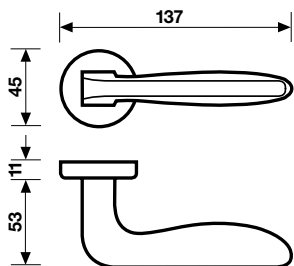

Orsatin/Orolucido

Cromo/Cromosat



Disponibile anche in versione antincendio secondo normativa Ö-NORM B 3859:2011
Available also in the fire-proof version according to Ö-NORM B 3859:2011 standards



Disponibile anche CLASSE 4 su R8 - RG8 secondo la norma DIN EN 1906 - Digit 4 7 - 0 0 - 0 B
Available also CLASS 4 on R8 - RG8 according to the DIN Standard EN 1906 - Digit 4 7 - 0 0 - 0 B



K 1112 / K 1112 Y
Pag. 138



K 1704 R6-7-8 50 BZG - 85
Pag. 153



K 1713 / K 1713 Y
Pag. 134



K 1704 RS6-7-8 50 BZG - 85
Pag. 154



K 1145 / K 1145 Y
Pag. 135



K 1123 RG6-7-8 BZG - 75
Pag. 152



In abbinamento sono disponibili | Coordinated accessories

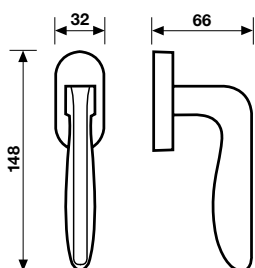

H 1022 FRS-41

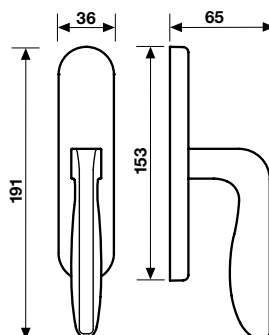

H 1022 F





H 1018 Serie Otello

Materiale Ottone | Material Brass

design Marius Schreyer Design

Valli&Valli
ASSA ABLOY

Maniglia per porta | Door handle

Finiture | Finishes

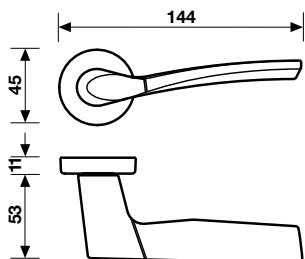

Orsatin/Orolucido

Cromo/Cromosat



Disponibile anche in versione antincendio secondo normativa **Ö-NORM B 3859:2011**
Available also in the fire-proof version according **Ö-NORM B 3859:2011 standards**



Disponibile anche **CLASSE 4 su R8 - RG8 secondo la norma DIN EN 1906 - Digit 4 7 - 0 0 - 0 B**
Available also **CLASS 4 on R8 - RG8 according to the DIN Standard EN 1906 - Digit 4 7 - 0 0 - 0 B**

K 1112 / K 1112 Y
Pag. 138



K 1704 R6-7-8 50 BZG - 85
Pag. 153



K 1713 / K 1713 Y
Pag. 134



K 1704 RS6-7-8 50 BZG - 85
Pag. 154



K 1145 / K 1145 Y
Pag. 135



K 1123 RG6-7-8 BZG - 75
Pag. 152



In abbinamento sono disponibili | Coordinated accessories

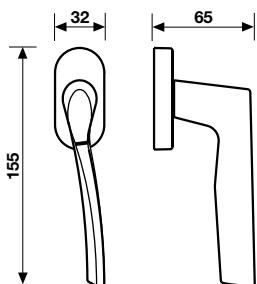

H 1018 FRS-41





H 1016 Serie Nabucco

Materiale Ottone | Material Brass

design Valli Workshop

Valli&Valli
ASSA ABLOY

Maniglia per porta | Door handle

Finiture | Finishes

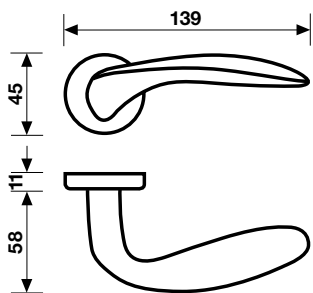

Orolucido

Cromosat

Anticato



Disponibile anche in versione antincendio secondo normativa **Ö-NORM B 3859:2011**
Available also in the fire-proof version according **Ö-NORM B 3859:2011 standards**



Disponibile anche **CLASSE 4 su R8 - RG8 secondo la norma DIN EN 1906 - Digit 4 7 - 0 0 - 0 B**
Available also **CLASS 4 on R8 - RG8 according to the DIN Standard EN 1906 - Digit 4 7 - 0 0 - 0 B**

K 1112 / K 1112 Y
Pag. 138



K 1704 R6-7-8 50 BZG - 85
Pag. 153



K 1713 / K 1713 Y
Pag. 134



K 1704 RS6-7-8 50 BZG - 85
Pag. 154



K 1145 / K 1145 Y
Pag. 135



K 1123 RG6-7-8 BZG - 75
Pag. 152



In abbinamento sono disponibili | Coordinated accessories

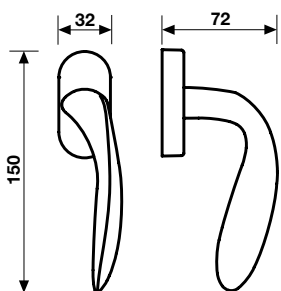

H 1016 FRS-41



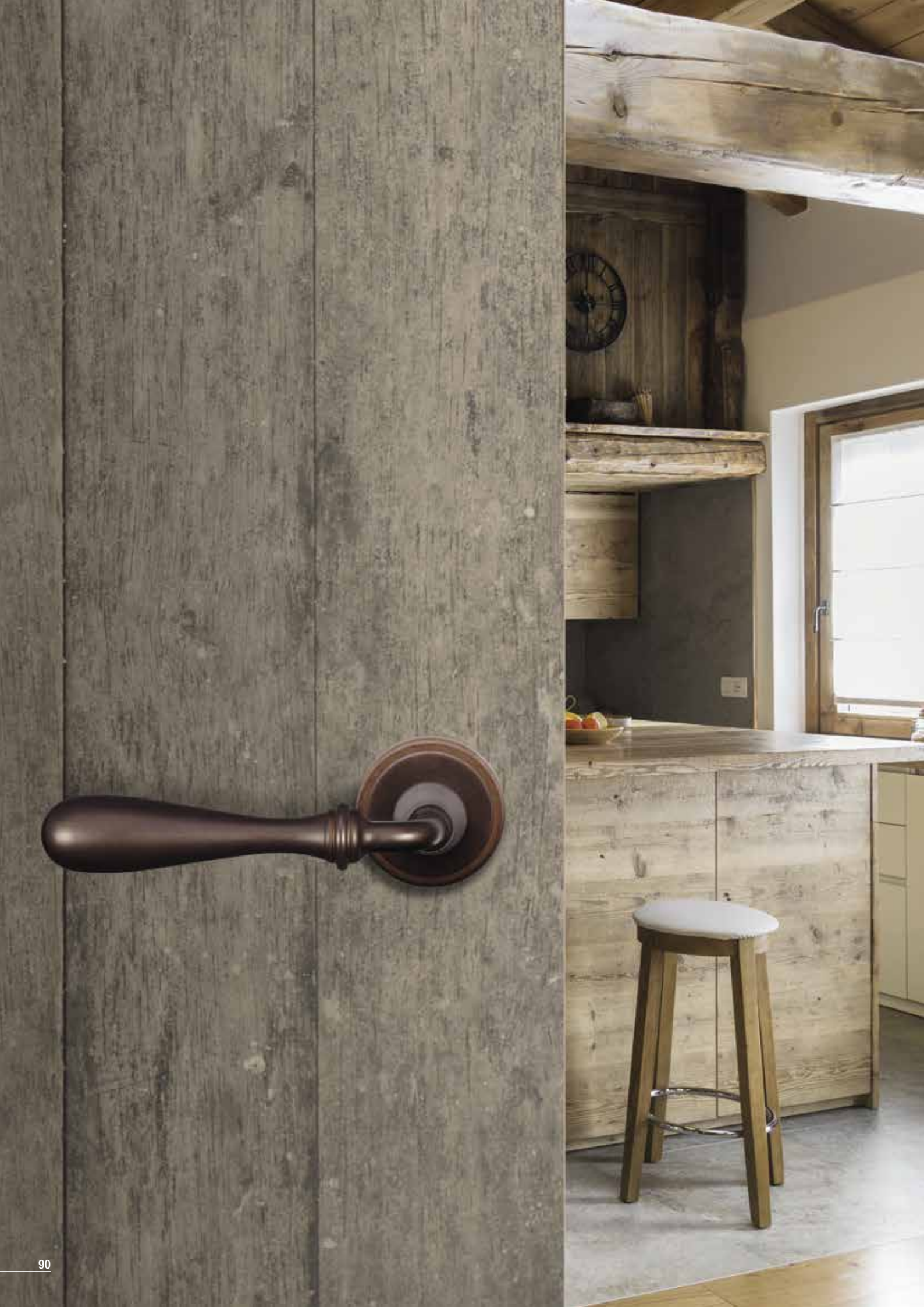

H 1004 Serie Antares

design Valli Workshop

Valli&Valli
ASSA ABLOY

Materiale Ottone/Ottone e Porcellana* | Material Brass/Brass and Porcelain*

Maniglia per porta | Door handle

Finiture | Finishes

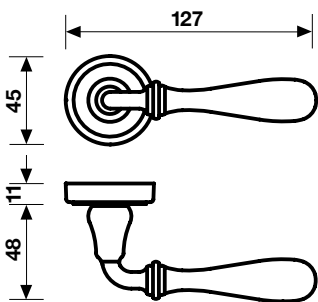

- Orolucido
- Ottone naturale
- Brunito
- Brunito/Avorio*



K 1110 / K 1110 Y
Pag. 139



K 1704 R6-7-8 50 BZG - 85
Pag. 153



K 1004 P8
Pag. 114

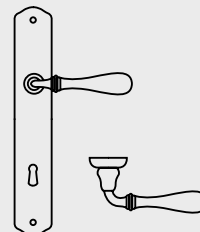

K 1755 / K 1755 Y
Pag. 134



K 1704 RS6-7-8 50 BZG - 85
Pag. 154



K 1145 / K 1145 Y
Pag. 135



K 1123 RG6-7-8 BZG - 75
Pag. 152



In abbinamento sono disponibili | Coordinated accessories

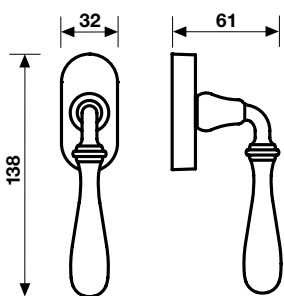

H 1004 FRS-41

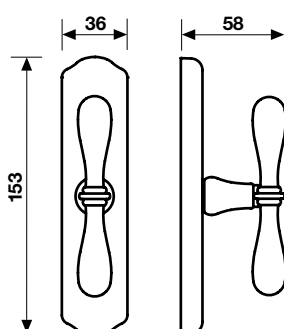

H 1004 F





H 1003 Serie Croco

Materiale Ottone | Material Brass

design Matteo Thun

V&V Valli&Valli
ASSA ABLOY

Maniglia per porta | Door handle **Finiture | Finishes**

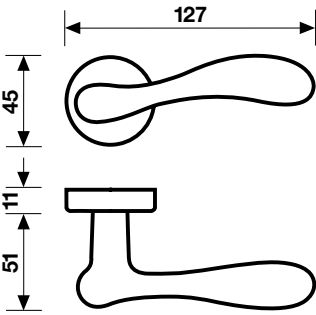

- Orolucido
- Orolucido/Orsatin
- Orsatin
- Cromo/Cromosat
- Cromosat
- Anticato



Disponibile anche in versione antincendio secondo normativa Ö-NORM B 3859:2011
Available also in the fire-proof version according to Ö-NORM B 3859:2011 standards



Disponibile anche CLASSE 4 su R8 - RG8 secondo la norma DIN EN 1906 - Digit 4 7 - 0 0 - 0 B
Available also CLASS 4 on R8 - RG8 according to the DIN Standard EN 1906 - Digit 4 7 - 0 0 - 0 B



K 1112 / K 1112 Y
Pag. 138



K 1704 R6-7-8 50 BZG - 85
Pag. 153



K 1713 / K 1713 Y
Pag. 134



K 1704 RS6-7-8 50 BZG - 85
Pag. 154



K 1145 / K 1145 Y
Pag. 135



K 1123 RG6-7-8 BZG - 75
Pag. 152



In abbinamento sono disponibili | Coordinated accessories

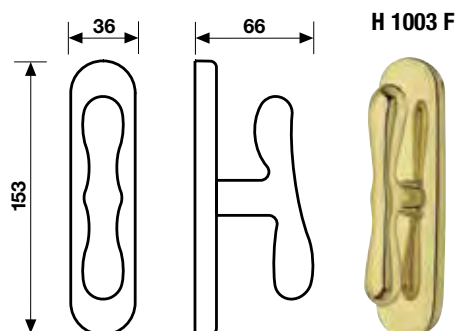
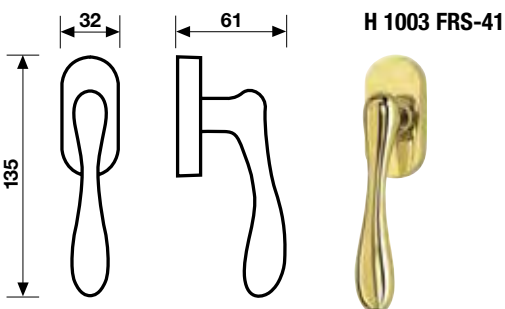



H 914/8 Serie Medicea

Materiale Ottone | Material Brass

design Pasquale Valli

Valli&Valli
ASSA ABLOY

Maniglia per porta | Door handle

Finiture | Finishes

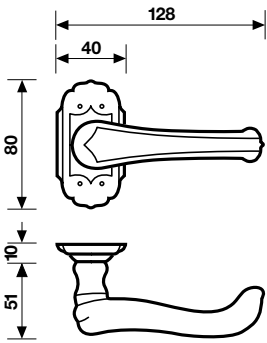

Patinè



K 915 / K 915 Y
Pag. 139

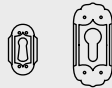

K 914/8
Pag. 114

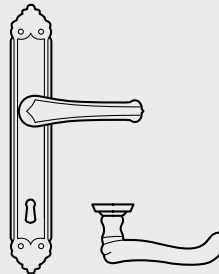

In abbinamento sono disponibili | Coordinated accessories

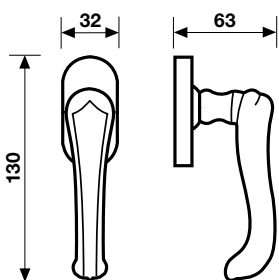

H 914 FRS-41

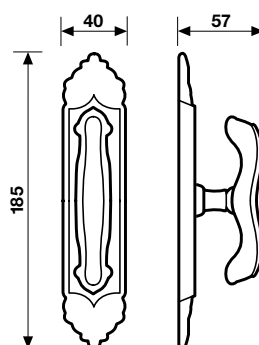

H 916 F





H 198 Serie Mizar

Materiale Ottone | Material Brass

design Eero Aarnio

Valli&Valli
ASSA ABLOY

Maniglia per porta | Door handle

Finiture | Finishes

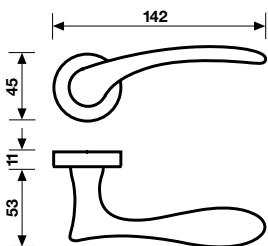

Orolucido

Orsatin

Cromosat

Anticato



Disponibile anche in versione antincendio secondo normativa Ö-NORM B 3859:2011
Available also in the fire-proof version according Ö-NORM B 3859:2011 standards



Disponibile anche CLASSE 4 su R8 - RG8 secondo la norma DIN EN 1906 - Digit 4 7 - 0 0 - 0 B
Available also CLASS 4 on R8 - RG8 according to the DIN Standard EN 1906 - Digit 4 7 - 0 0 - 0 B



K 1112 / K 1112 Y
Pag. 138

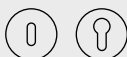

K 1704 R6-7-8 50 BZG - 85
Pag. 153



K 1210
Pag. 130

K 198 P8
Pag. 114

K 1713 / K 1713 Y
Pag. 134



K 1704 RS6-7-8 50 BZG - 85
Pag. 154

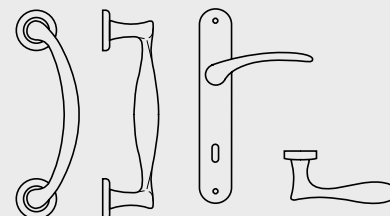

K 1145 / K 1145 Y
Pag. 135



K 1123 RG6-7-8 BZG - 75
Pag. 152



In abbinamento sono disponibili | Coordinated accessories

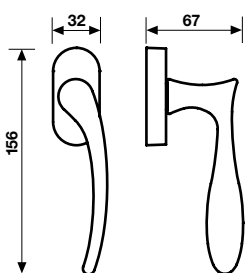

H 198 FRS-41

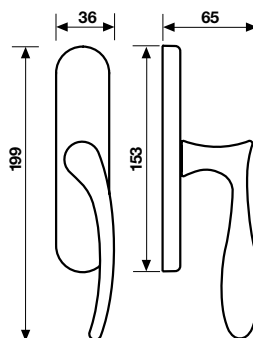

H 198 F





H 192 Serie Prunus

Materiale Ottone | Material Brass

design Valli Workshop

Valli&Valli
ASSA ABLOY

Maniglia per porta | Door handle

Finiture | Finishes

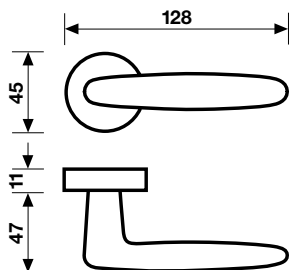

Nikmatt



Disponibile anche in versione antincendio secondo normativa Ö-NORM B 3859:2011
Available also in the fire-proof version according Ö-NORM B 3859:2011 standards



Disponibile anche CLASSE 4 su R8 - RG8 secondo la norma DIN EN 1906 - Digit 4 7 - 0 0 - 0 B
Available also CLASS 4 on R8 - RG8 according to the DIN Standard EN 1906 - Digit 4 7 - 0 0 - 0 B



K 1112 / K 1112 Y
Pag. 138

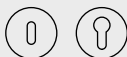

K 1704 R6-7-8 50 BZG - 85
Pag. 153



K 1713 / K 1713 Y
Pag. 134



K 1704 RS6-7-8 50 BZG - 85
Pag. 154



K 1145 / K 1145 Y
Pag. 135



K 1123 RG6-7-8 BZG - 75
Pag. 152



In abbinamento sono disponibili | Coordinated accessories

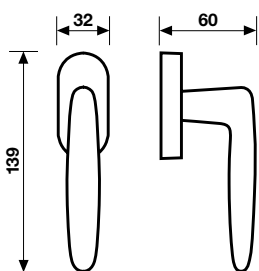

H 192 FRS-41

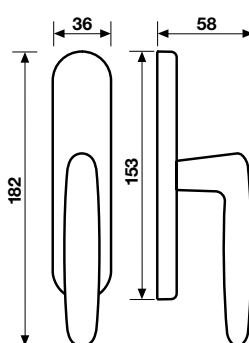

H 192 F





H 176 Serie Spiga

Materiale Ottone e Porcellana | Material Brass and Porcelain

design Valli Workshop

Valli&Valli
ASSA ABLOY

Maniglia per porta | Door handle

Finiture | Finishes

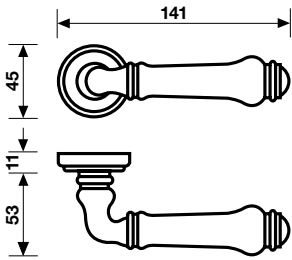

Bianco/Orolucido

Fiorato/Orolucido

Brunito/Avorio

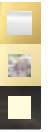

K 1110 / K 1110 Y
Pag. 138



K 1704 R6-7-8 50 BZG - 85
Pag. 153



K 1755 / K 1755 Y
Pag. 134



K 1704 RS6-7-8 50 BZG - 85
Pag. 154



K 1145 / K 1145 Y
Pag. 135



K 1123 RG6-7-8 BZG - 75
Pag. 152



In abbinamento sono disponibili | Coordinated accessories

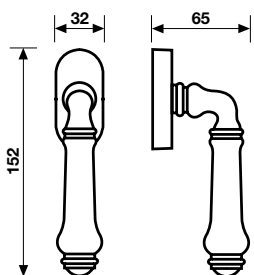

H 176 FRS-41

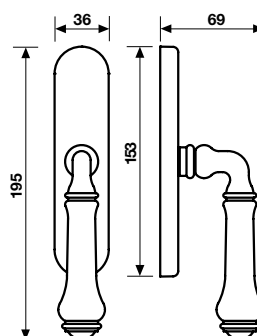

H 176 F





H 165 Serie Germana

Materiale Ottone | Material Brass

design Valli Workshop

Valli&Valli
ASSA ABLOY

Maniglia per porta | Door handle

Finiture | Finishes

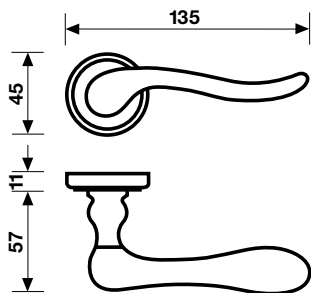

Orolucido

Orsatin

Anticato



Disponibile anche in versione antincendio secondo normativa Ö-NORM B 3859:2011
Available also in the fire-proof version according to Ö-NORM B 3859:2011 standards



Disponibile anche CLASSE 4 su R8 - RG8 secondo la norma DIN EN 1906 - Digit 4 7 - 0 0 - 0 B
Available also CLASS 4 on R8 - RG8 according to the DIN Standard EN 1906 - Digit 4 7 - 0 0 - 0 B

K 1110 / K 1110 Y
Pag. 139



K 1704 R6-7-8 50 BZG - 85
Pag. 153



K 165 P8
Pag. 115

K 1755 / K 1755 Y
Pag. 134



K 1704 RS6-7-8 50 BZG - 85
Pag. 154



K 1145 / K 1145 Y
Pag. 135



K 1123 RG6-7-8 BZG - 75
Pag. 152

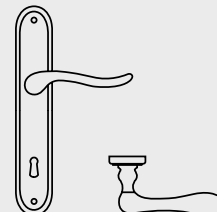

In abbinamento sono disponibili | Coordinated accessories

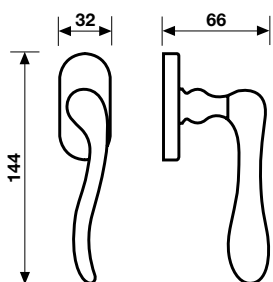

H 165 FRS-41

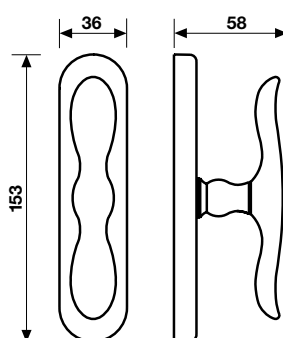

H 165 F





H 163 Serie Sarissa

Materiale Ottone | Material Brass

design Valli Workshop

Valli&Valli
ASSA ABLOY

Maniglia per porta | Door handle **Finiture | Finishes**

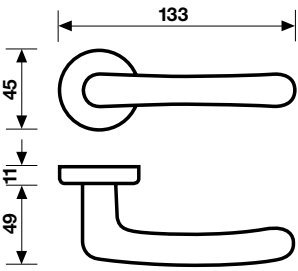

- Orolucido
- Cromo
- Cromosat



Disponibile anche in versione antincendio secondo normativa Ö-NORM B 3859:2011
Available also in the fire-proof version according Ö-NORM B 3859:2011 standards



Disponibile anche CLASSE 4 su R8 - RG8 secondo la norma DIN EN 1906 - Digit 4 7 - 0 0 - 0 B
Available also CLASS 4 on R8 - RG8 according to the DIN Standard EN 1906 - Digit 4 7 - 0 0 - 0 B



K 1112 / K 1112 Y
Pag. 138



K 1704 R6-7-8 50 BZG - 85
Pag. 153



K 1713 / K 1713 Y
Pag. 134



K 1704 RS6-7-8 50 BZG - 85
Pag. 154



K 1145 / K 1145 Y
Pag. 135



K 1123 RG6-7-8 BZG - 75
Pag. 152



In abbinamento sono disponibili | Coordinated accessories

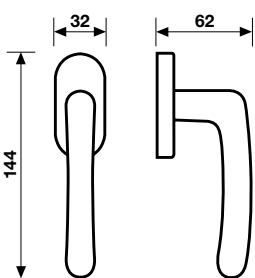

H 163 FRS-41

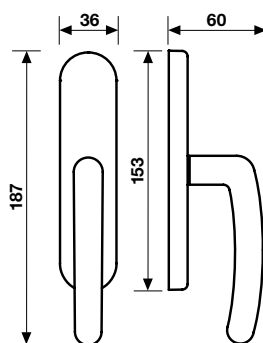

H 163 F





H 123 Serie Luigi XVI

Materiale Ottone | Material Brass

design Valli Workshop

Valli&Valli
ASSA ABLOY

Maniglia per porta | Door handle

Finiture | Finishes

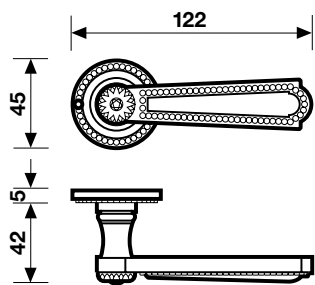

Orolucido

Ottone antico

K 195 / K 195 Y
Pag. 139



K 121 / K 121 Y
Pag. 122



In abbinamento sono disponibili | Coordinated accessories

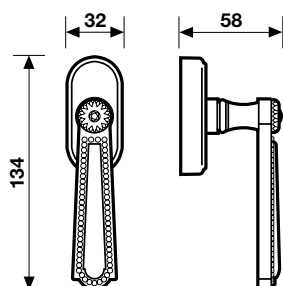

H 123 FRS-41





H 419 Serie Bordeaux

Materiale Acciaio Inox AISI 304 | Material Stainless Steel AISI 304

design Valli Workshop

Valli&Valli
ASSA ABLOY

Maniglia per porta | Door handle

Finiture | Finishes

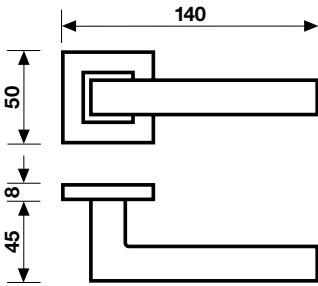

Acciaio inox satinato



K 49 / K 49 Y
Pag. 140



K 465 / K 465 Y
Pag. 122



K 5148 / K 5148 Y
Pag. 141



K 411 R6-7-8 50 BZG - 75
Pag. 156

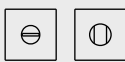

In abbinamento sono disponibili | Coordinated accessories

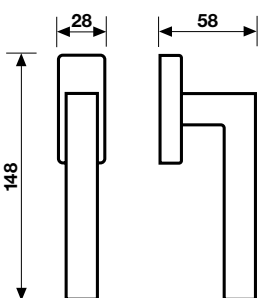

H 419 FRS-41





H 416 Serie Garnet

Materiale Acciaio Inox AISI 304 | Material Stainless Steel AISI 304

design Valli Workshop

Valli&Valli
ASSA ABLOY

Maniglia per porta | Door handle

Finiture | Finishes

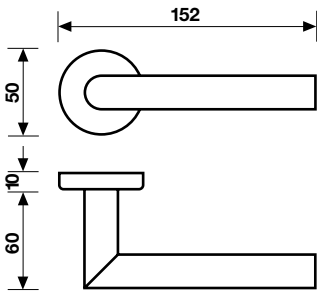

Acciaio inox satinato



K 48 / K 48 Y
Pag. 140



K 48 OV N / K 48 OV Y
Pag. 141



K 412 R6-7-8 50 BZG - 75
Pag. 156



In abbinamento sono disponibili | Coordinated accessories

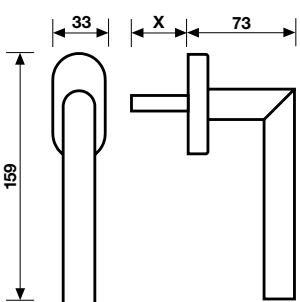

H 416 FRS



X = mis. 30/35/41/50



H 414 Serie Amber

Materiale Acciaio Inox AISI 304 | Material Stainless Steel AISI 304

design Valli Workshop

Valli&Valli
ASSA ABLOY

Maniglia per porta | Door handle

Finiture | Finishes

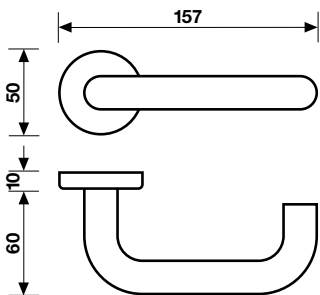

Acciaio inox satinato



K 48 / K 48 Y
Pag. 140



K 48 OV N / K 48 OV Y
Pag. 141



K 412 R6-7-8 50 BZG - 75
Pag. 156



In abbinamento sono disponibili | Coordinated accessories

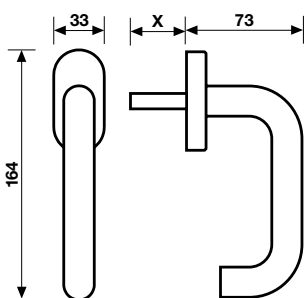

H 414 FRS



X = mis. 30/35/41/50

H 1004 P8

Materiale Ottone | Material Brass

design Valli Workshop

Coordinati | Accessories

Finiture | Finishes

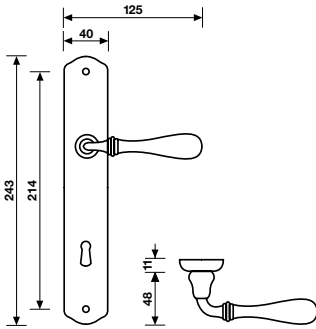

- H 1004 P8 70
- H 1004 P8 90
- H 1004 P8 Y 85



Orolucido

Brunito

H 914/8

Materiale Ottone | Material Brass

design Pasquale Valli

Coordinati | Accessories

Finiture | Finishes

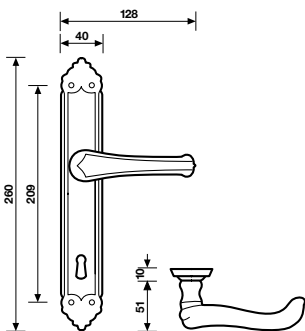

- H 914/8 70
- H 914/8 90
- H 914/8 Y 85



Patiné

H 198 P8

Materiale Ottone | Material Brass

design Eero Aarnio

Coordinati | Accessories

Finiture | Finishes

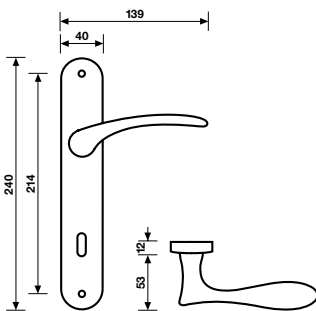

- H 198 P8 70
- H 198 P8 90
- H 198 P8 Y 85



Orolucido

Anticato

Coordinati | Accessories

Finiture | Finishes

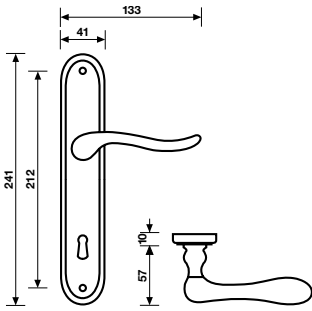

H 165 P8 70
H 165 P8 90
H 165 P8 Y 85



Orolucido

Anticato

K 1730

Materiale Ottone | Material Brass

design Valli Workshop

Coordinati | Accessories

Finiture | Finishes

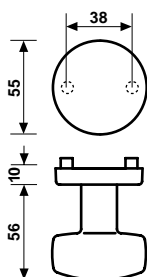

K 1730 RG



Cromo

Cromosat

Nikmatt

Orolucido



K 1172

Materiale Alluminio | Material Aluminium

design Valli Workshop

Coordinati | Accessories

Finiture | Finishes

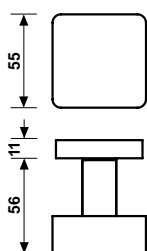

K 1172 R8

K 1172 R8 Y



Cromo

Cromosat



K 1171

Materiale Alluminio | Material Aluminium

design Valli Workshop

Coordinati | Accessories

Finiture | Finishes

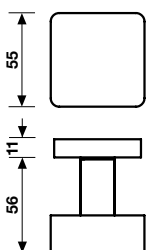

K 1171 R8

K 1171 R8 Y



Cromo

Cromosat



K 1170

Materiale Alluminio | Material Aluminium

design Valli Workshop

Coordinati | Accessories

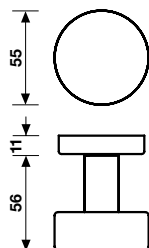

K 1170 R8
K 1170 R8 Y



Finiture | Finishes

Cromo
Cromosat
Bronzop (Ottone)
Neropaco
Biancopaco



K 1168

Materiale Alluminio | Material Aluminium

design Valli Workshop

Coordinati | Accessories

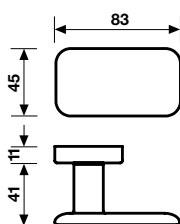

K 1168 R8
K 1168 R8 Y



Finiture | Finishes

Cromo
Cromosat
Orsatin



K 1166

Materiale Nikrall Lega Zama UNI 3717 | Material Nikrall Lega Zama UNI 3717

design Valli Workshop

Coordinati | Accessories

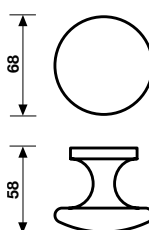

K 1166
Pomolo Fisso
Fixed knob



Finiture | Finishes

Cromo
Cromosat
Orolucido - PVD



K 1160

Materiale Ottone | Material Brass

design Valli Workshop

Coordinati | Accessories

Finiture | Finishes

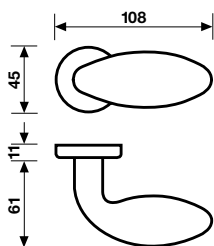

K 1160 R8
K 1160 R8 Y



Orolucido
Ottone naturale
Cromosat
Orolucido - PVD



K 1155 A

Materiale Ottone | Material Brass

design Valli Workshop

Coordinati | Accessories

Finiture | Finishes

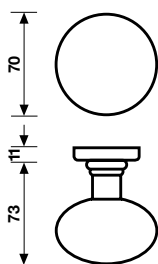

K 1155 A R8



Orolucido
Orsatin
Cromo
Cromosat
Anticato
Brunito
Orolucido - PVD



K 1155

Materiale Ottone | Material Brass

design Valli Workshop

Coordinati | Accessories

Finiture | Finishes

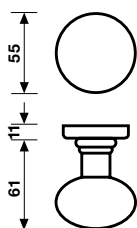

K 1155 R8
K 1155 R8 Y



Orolucido
Orsatin
Ottone naturale
Cromo
Cromosat
Anticato
Brunito

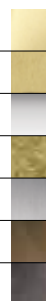

Coordinati | Accessories

Finiture | Finishes

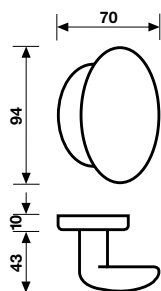

K 1153 R SB



Orolucido

Cromosat

Orolucido - PVD



K 1153 PY

Coordinati | Accessories

Finiture | Finishes

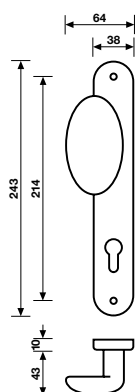

K 1153 PY D/S 85



Orolucido

Cromosat



K 1067 Serie Rose

Coordinati | Accessories

Finiture | Finishes

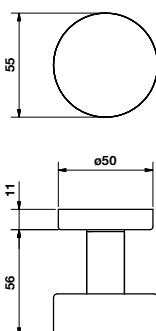

K 1067 R8

K 1067 R8 Y



Metallo rame lucido

Metallo rame satinato



K 1061 Serie Cenerentola

Materiale Ottone | Material Brass

design Luciana Di Virgilio
e Gianni Veneziano

Coordinati | Accessories

Finiture | Finishes

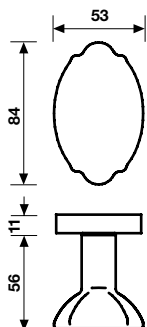

K 1061 R8
K 1061 R8 Y



Bronzop

Light Black

Orsatin



K 1060 Serie Alina

Materiale Ottone | Material Brass

design Skidmore, Owings & Merrill

Coordinati | Accessories

Finiture | Finishes

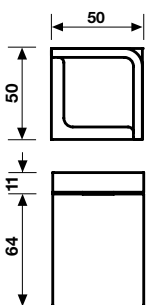

K 1060 R8
K 1060 R8 Y



Cromo

Cromosat

Neropaco

K 1056 T Serie Quadra

Materiale Ottone | Material Brass

design Valli Workshop

Coordinati | Accessories

Finiture | Finishes

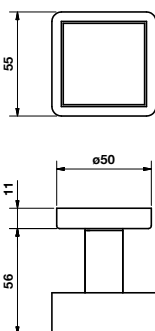

K 1056 T R8
K 1056 T R8 Y



Cromo (Alluminio)

Nikelnero

Neropaco



K 1056 Serie Quadra

Materiale Ottone | Material Brass

design Valli Workshop

Coordinati | Accessories

Finiture | Finishes

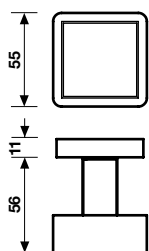

K 1056 R8
K 1056 R8 Y



Cromo (Alluminio)
Nikelnero
Neropaco



K 1055 Serie Words

Materiale Alluminio | Material Aluminium

design Franco Poli

Coordinati | Accessories

Finiture | Finishes

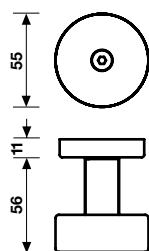

K 1055 R8
K 1055 R8 Y



Cromo/Neropaco
Cromosat/Neropaco



K 1054 Serie w.w.

Materiale Alluminio | Material Aluminium

design Valli Workshop

Coordinati | Accessories

Finiture | Finishes

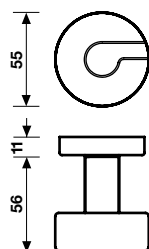

K 1054 R8
K 1054 R8 Y



Cromo
Nikmatt
Orsatop (Ottone)
Ramematt



Coordinati | Accessories

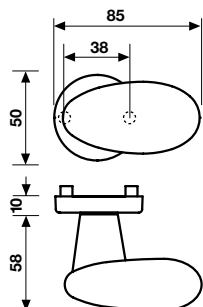

K 142 RG



Finiture | Finishes

Cromo

Cromosat

Orolucido



K 121 Serie Luigi XVI

Materiale Ottone | Material Brass

design Valli Workshop

Coordinati | Accessories

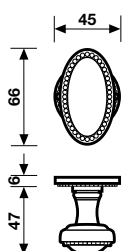

K 121 R8
K 121 R8 Y



Finiture | Finishes

Orolucido

Ottone antico



K 465

Materiale Acciaio Inox AISI 304 | Material Stainless Steel AISI 304

design Valli Workshop

Coordinati | Accessories

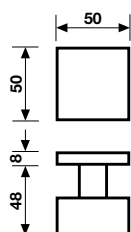

K 465 R8
K 465 R8 Y



Finiture | Finishes

Acciaio inox satinato



K 1235

Materiale Alluminio | Material Aluminium

design Valli Workshop

Coordinati | Accessories

Finiture | Finishes

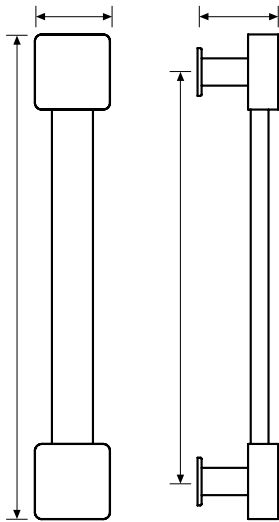

K 1235



Cromo

Cromosat

Bronzsat (Ottone)



K 1231

Materiale Alluminio | Material Aluminium

design Valli Workshop

Coordinati | Accessories

Finiture | Finishes

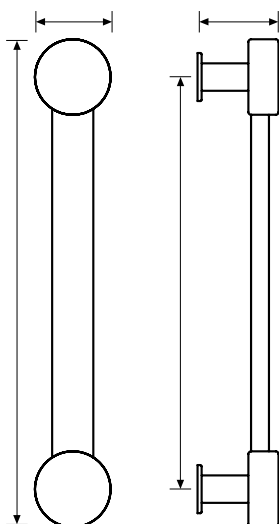

K 1231



Cromo

Cromosat

Bronzop (Ottone)

Neropaco

Biancopaco



Coordinati | Accessories

Finiture | Finishes

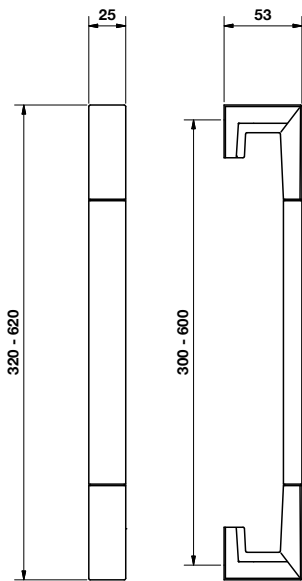

K 1068



Cromo

Cromosat

Cromo/Cromosat



K 1067 Serie Rose
Materiale Rame | Material Copper

design Valli Workshop

Coordinati | Accessories

Finiture | Finishes

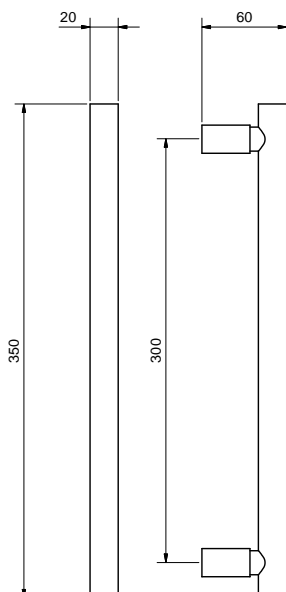

K 1067



Metallo rame lucido

Metallo rame satinato



Coordinati | Accessories

Finiture | Finishes

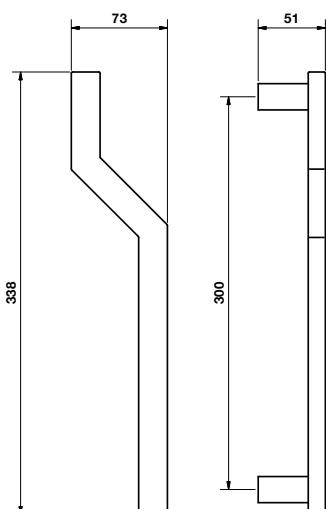

K 1066



Orsatop

Cromosat

Nikelnero

Titanium - PVD



K 1061 Serie Cenerentola

Coordinati | Accessories

Finiture | Finishes

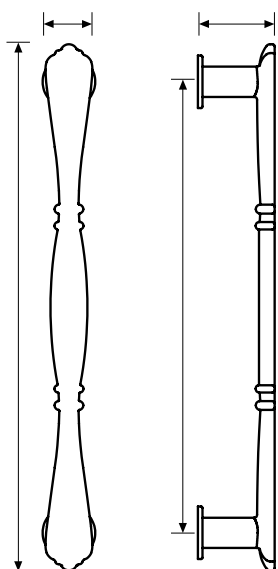

K 1061



Bronzop

Light Black

Orsatin



Coordinati | Accessories

Finiture | Finishes

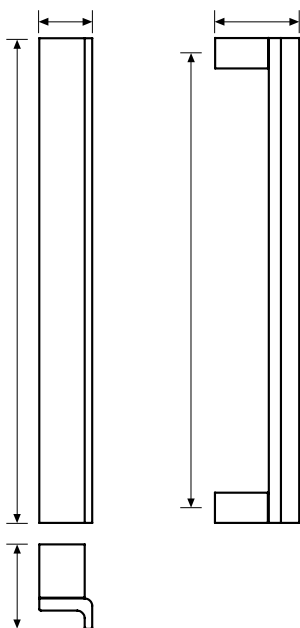

K 1060



Cromosat

Cromo

Neropaco

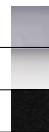

K 1056 Serie Quadra

Coordinati | Accessories

Finiture | Finishes

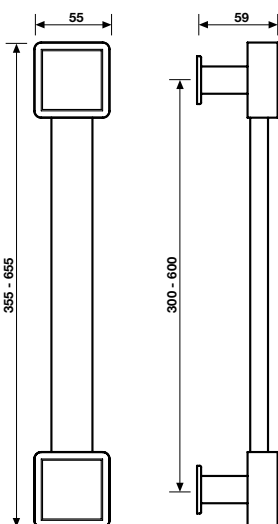

K 1056



Cromo (Alluminio)

Nikelnero

Neropaco



Coordinati | Accessories

Finiture | Finishes

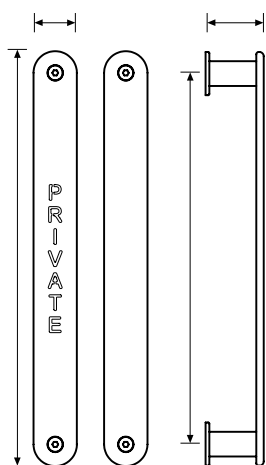

K 1055

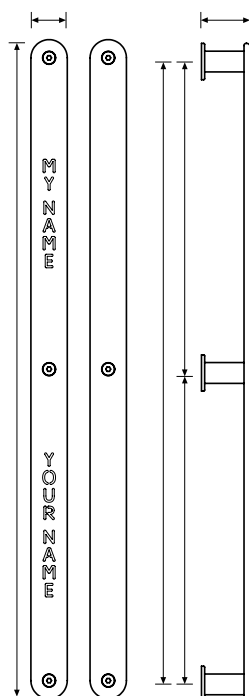

Cromo/Neropaco

Cromosat/Neropaco



K 1054 Serie w.w.

Coordinati | Accessories

Finiture | Finishes

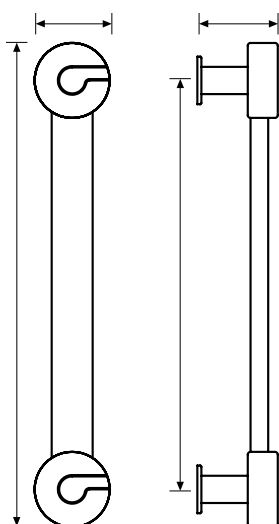

K 1054



Cromo

Nikmatt

Orsatop (Ottone)

Ramematt



Coordinati | Accessories

Finiture | Finishes

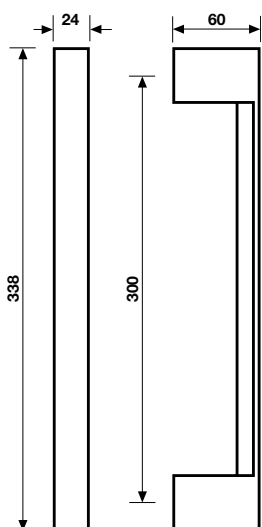

K 1228



Cromo

Cromosat

Nikelnero



K 1226 Serie Fedra

Coordinati | Accessories

Finiture | Finishes

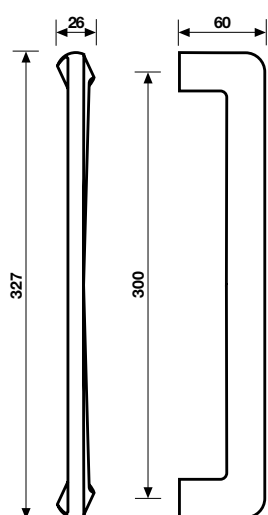

K 1226



Orolucido

Cromo/Cromosat



K 1224

Materiale Acciaio Inox AISI 304 | Material Stainless Steel AISI 304

design Valli Workshop

Coordinati | Accessories

Finiture | Finishes

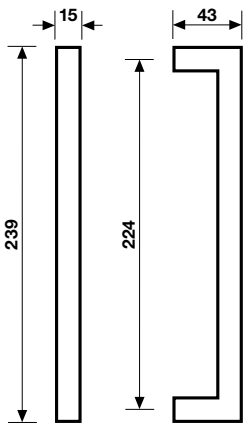

K 1224



Acciaio inox satinato

K 1219

Materiale Acciaio Inox AISI 304 | Material Stainless Steel AISI 304

design Valli Workshop

Coordinati | Accessories

Finiture | Finishes

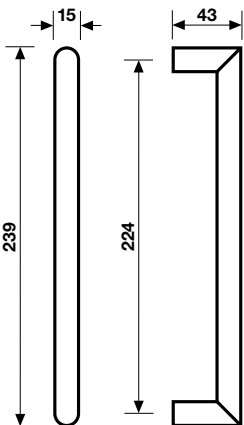

K 1219



Acciaio inox satinato

Coordinati | Accessories

Finiture | Finishes

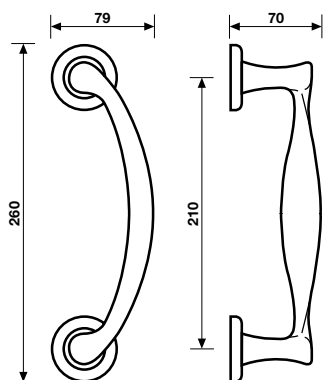

K 1210



- Orolucido
- Orsatin
- Cromosat
- Anticato
- Orolucido - PVD



K 1188

Coordinati | Accessories

Finiture | Finishes

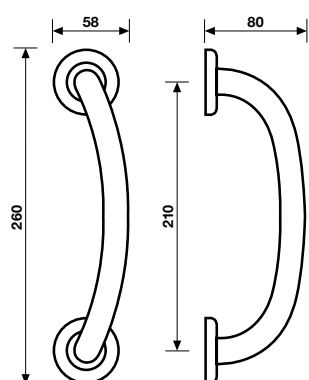

K 1188



- Orolucido
- Orsatin
- Cromosat
- Brunito
- Orolucido - PVD



Coordinati | Accessories

Finiture | Finishes

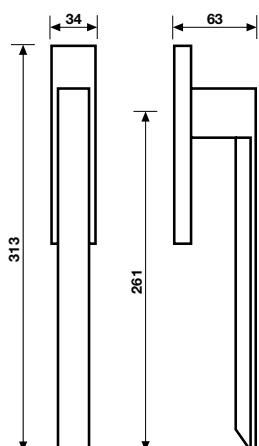

K 169
K 169 Y
K 169 PL N

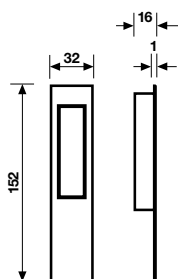

Cromo

Cromosat/Cromo

Cromosat

Nikelnero



K 163

Materiale Ottone | Material Brass

design Valli Workshop

Coordinati | Accessories

Finiture | Finishes

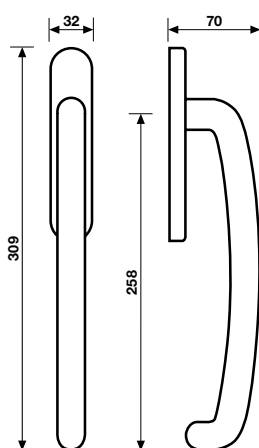

K 163
K 163 Y
K 163 PL N

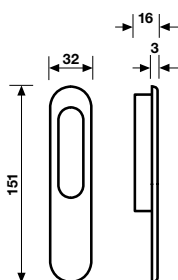

Orolucido

Ottone naturale

Cromosat

Brunito

Bronzop

Nikelnero

Cromo

Biancopaco



Coordinati | Accessories

Finiture | Finishes

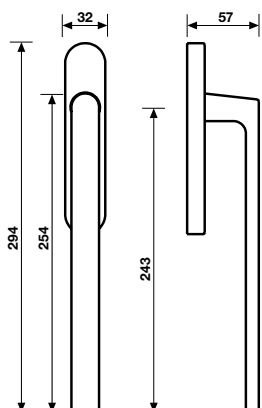

K 411
K 411 Y
K 163 PL N

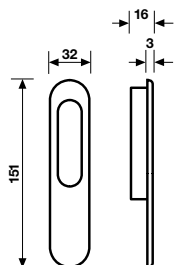

Cromo

Cromosat

Biancopaco



K 411 Q

Materiale Ottone | Material Brass

design Valli Workshop

Coordinati | Accessories

Finiture | Finishes

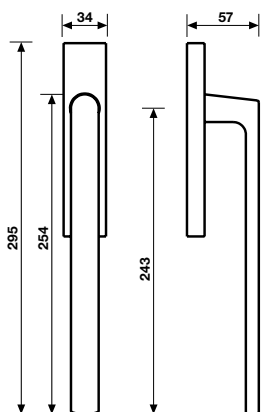

K 411 Q
K 411 Q Y
K 169 PL N

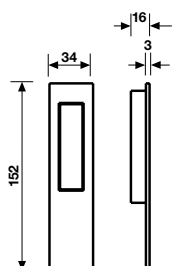

Cromo

Cromosat

Biancopaco



Coordinati | Accessories

Finiture | Finishes

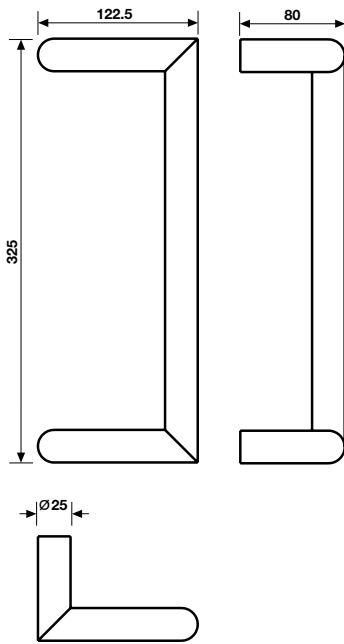

K 466 25
K 466 S 25



Acciaio inox satinato

K 464

Materiale Acciaio Inox AISI 304 | Material Stainless Steel AISI 304

design Valli Workshop

Coordinati | Accessories

Finiture | Finishes

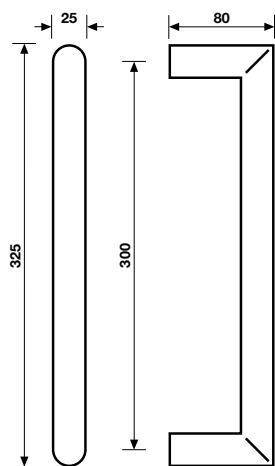

K 464 25
K 464 S 25

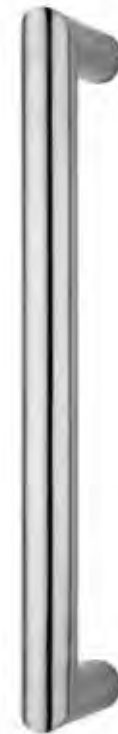

Acciaio inox satinato

K 1755

Materiale Ottone | Material Brass

Coordinati | Accessories

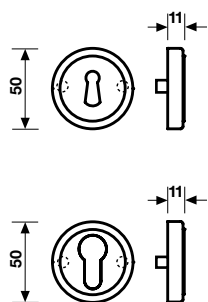

K 1755



K 1755 Y

Finiture | Finishes

Anticato

Orolucido

Ottone antico

Brunito

Orsatin



K 1713

Materiale Ottone | Material Brass

Coordinati | Accessories

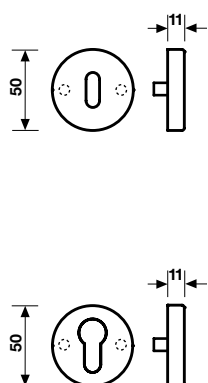

K 1713



K 1713 Y

Finiture | Finishes

Anticato

Cromo

Cromosat

Orolucido

Orolux

Orsatin

Orsatorp

Orolucido - PVD

Bronzop

Neropaco

Biancopaco

Ramematt

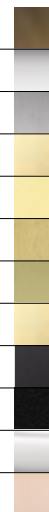

K 1197

Materiale Rame | Material Copper

Coordinati | Accessories

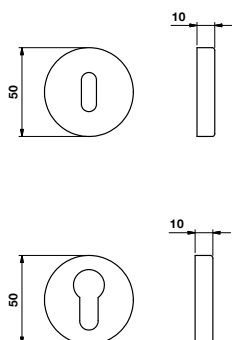

K 1197



K 1197 Y

Finiture | Finishes

Metallo rame lucido

Metallo rame satinato



K 1148

Materiale Ottone | Material Brass

Coordinati | Accessories

Finiture | Finishes

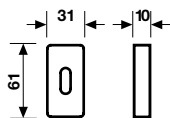

K 1148

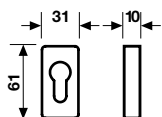

K 1148 Y

Cromo

Cromosat

Light Black

Neropaco

K 1145

Materiale Ottone | Material Brass

Coordinati | Accessories

Finiture | Finishes

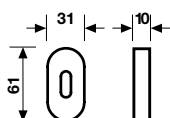

K 1145 R8

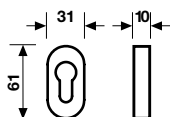

K 1145 R8 Y

Orolucido

Orsatin

Ottone naturale

Cromo

Cromosat

Anticato

Brunito

Ottone antico

Orolux

Orsatop

Nikmatt

Orolucido - PVD

Bronzop

Biancopaco

Nikelnero

Ramematt

K 1144 CP

Materiale Nikrall Lega Zama UNI 3717 | Material Nikrall Lega Zama UNI 3717

Coordinati | Accessories

Finiture | Finishes

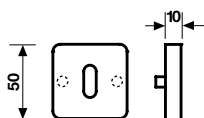

K 1144 CP

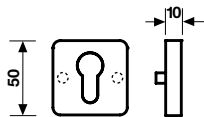

K 1144 Y CP

Cromo

Cromosat

Light Black

Neropaco

K 1143

Materiale Nikrall Lega Zama UNI 3717 | Material Nikrall Lega Zama UNI 3717

Coordinati | Accessories

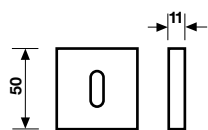

K 1143

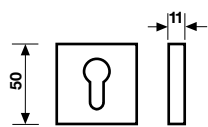

K 1143 Y

Finiture | Finishes

Cromo

Cromosat

Neropaco

Bronzsat (Ottone)

Nikelnero



K 1143 CP

Materiale Nikrall Lega Zama UNI 3717 | Material Nikrall Lega Zama UNI 3717

Coordinati | Accessories

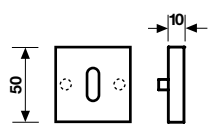

K 1143 CP

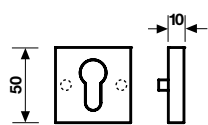

K 1143 Y CP

Finiture | Finishes

Cromo

Cromosat

Nikelnero

Neropaco

K 1142

Materiale Nikrall Lega Zama UNI 3717 | Material Nikrall Lega Zama UNI 3717

Coordinati | Accessories

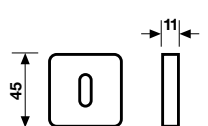

K 1142

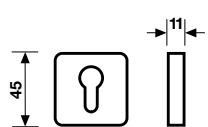

K 1142 Y

Finiture | Finishes

Cromo

Cromosat

Light Black

Neropaco

K 1139

Materiale Nikrall Lega Zama UNI 3717 | Material Nikrall Lega Zama UNI 3717

Coordinati | Accessories

Finiture | Finishes

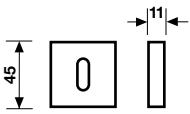

K 1139

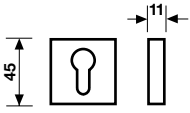

K 1139 Y

Cromo

Cromosat

Neropaco

K 1132

Materiale Ottone | Material Brass

Coordinati | Accessories

Finiture | Finishes

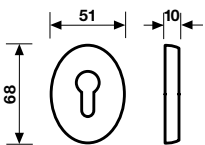

K 1132 Y

Orolucido

Cromosat

K 1122

Materiale Ottone | Material Brass

Coordinati | Accessories

Finiture | Finishes

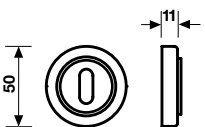

K 1122

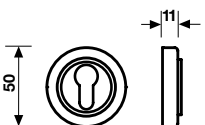

K 1122 Y

Bronzop

Cromo

Orolucido

K 1121

Materiale Ottone | Material Brass

Coordinati | Accessories

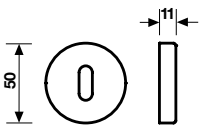

K 1121

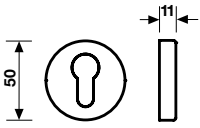

K 1121 Y

Finiture | Finishes

Orolucido

Orolux

Orsatop

Cromo

Cromosat

Nikmatt

Anticato

Bronzop

Neropaco

Biancopaco

Bronzsat

Ramematt



K 1112

Materiale Ottone | Material Brass

Coordinati | Accessories

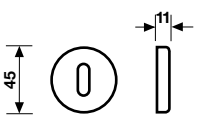

K 1112

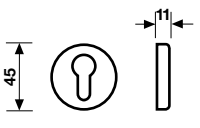

K 1112 Y

Finiture | Finishes

Orolucido

Orolux

Orsatin

Ottone naturale

Cromo

Cromosat

Anticato

Brunito

Orolucido - PVD

Biancopaco

Bronzop

Nikelnero

K 1110

Materiale Ottone | Material Brass

Coordinati | Accessories

Finiture | Finishes

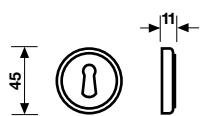

K 1110

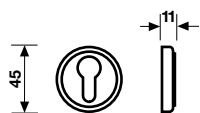

K 1110 Y

Orolucido

Orsatin

Ottone naturale

Anticato

Brunito

Ottone antico



K 915

Materiale Ottone | Material Brass

Coordinati | Accessories

Finiture | Finishes

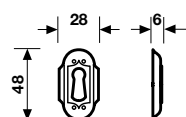

K 915

Patinè

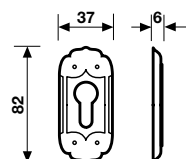

K 915 Y



K 195

Materiale Ottone | Material Brass

Coordinati | Accessories

Finiture | Finishes

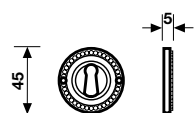

K 195

Orolucido

Ottone antico



K 195 Y



K 194

Materiale Ottone | Material Brass

Coordinati | Accessories

Finiture | Finishes

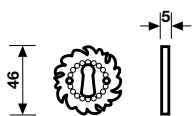

K 194

Orolucido

Ottone antico

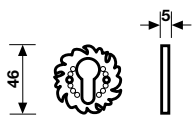

K 194 Y



K 49

Materiale Acciaio Inox AISI 304 | Material Stainless Steel AISI 304

Coordinati | Accessories

Finiture | Finishes

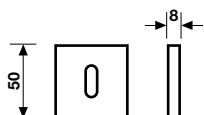

K 49

Acciaio inox satinato

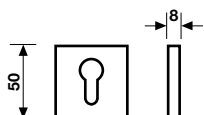

K 49 Y



K 48

Materiale Acciaio Inox AISI 304 | Material Stainless Steel AISI 304

Coordinati | Accessories

Finiture | Finishes

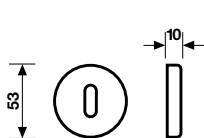

K 48

Acciaio inox satinato

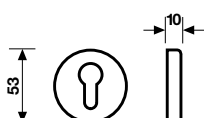

K 48 Y



K 48 OV

Materiale Acciaio Inox AISI 304 | Material Stainless Steel AISI 304

Coordinati | Accessories

Finiture | Finishes

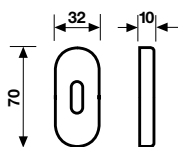

K 48 OV N

Acciaio inox satinato

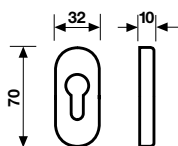

K 48 OV Y

K 5148

Materiale Acciaio Inox AISI 304 | Material Stainless Steel AISI 304

Coordinati | Accessories

Finiture | Finishes

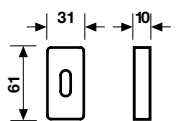

K 5148

Acciaio inox satinato

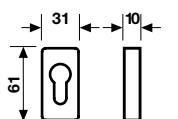

K 5148 Y

K 1136 PL

Materiale Ottone | Material Brass

Coordinati | Accessories

Finiture | Finishes

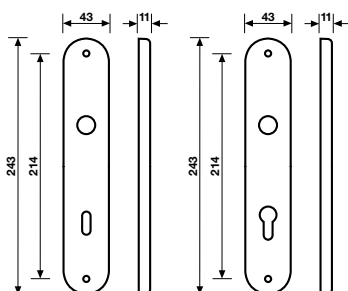

K 1136 PL 70
K 1136 PL 90
K 1136 PL 85



Orolucido

Orsatin

Ottone naturale

Cromo

Cromosat

Anticato

Brunito

Coordinati | Accessories

Finiture | Finishes

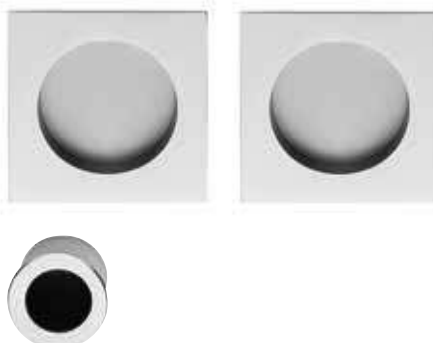
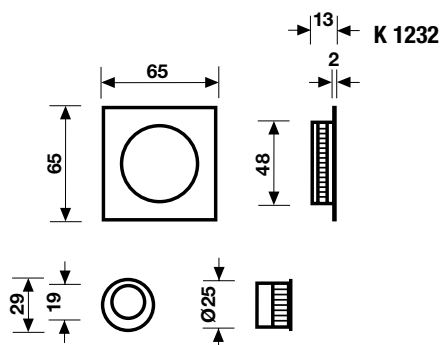

Cromo

Cromosat

Nikelnero



K 1230 Serie Bess
Materiale Ottone | Material Brass

Coordinati | Accessories

Finiture | Finishes

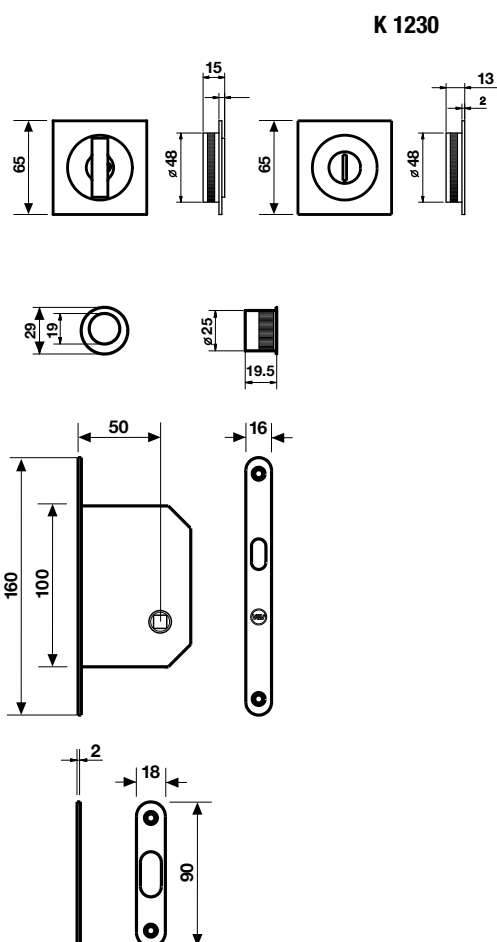

Cromo

Cromosat

Nikelnero



Coordinati | Accessories **Finiture | Finishes**

K 1215 SFC

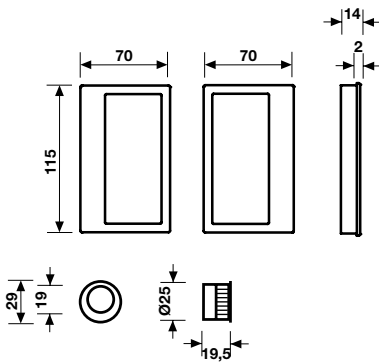

Cromo

Cromosat



K 1215

Coordinati | Accessories **Finiture | Finishes**

K 1215

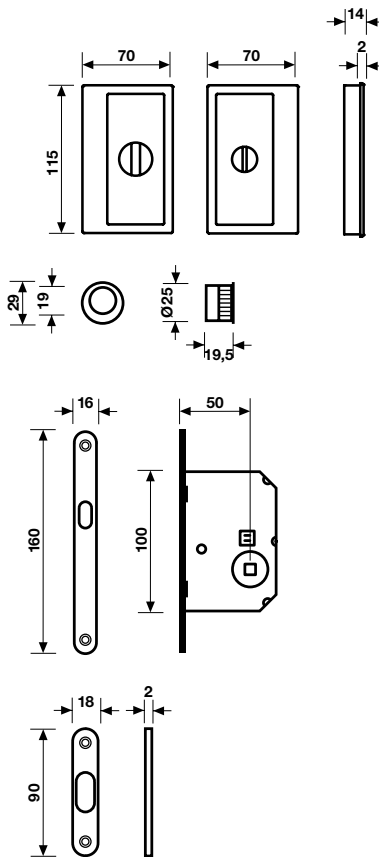

Cromo

Cromosat



Coordinati | Accessories

Finiture | Finishes

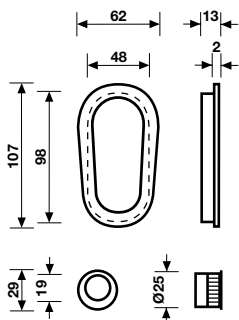

K 1212



Orolucido

Cromosat



K 1211 Serie Orfeide
Materiale Ottone | Material Brass

Coordinati | Accessories

Finiture | Finishes

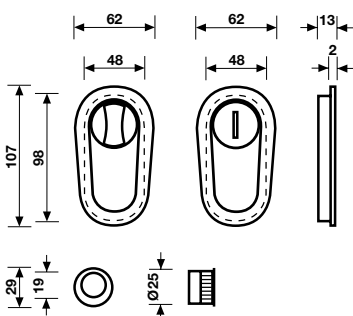

K 1211



Orolucido

Cromosat

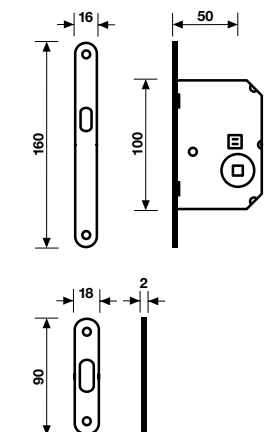

Coordinati | Accessories

Finiture | Finishes

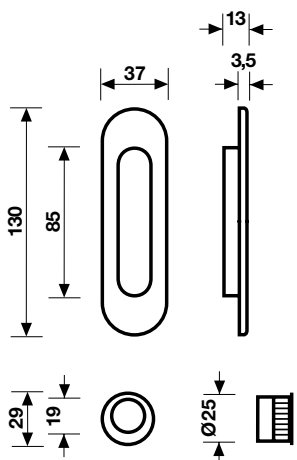

K 1206



Orolucido

Orsatin

Cromo

Cromosat

Anticato



K 1204 Serie Tancredi

Coordinati | Accessories

Finiture | Finishes

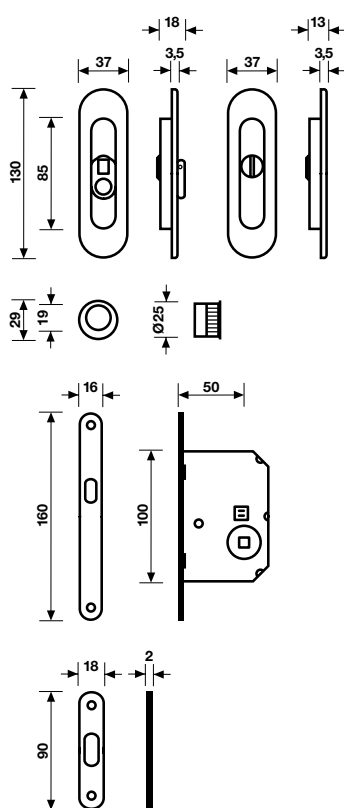

K 1204



Orolucido

Orsatin

Cromo

Cromosat

Anticato



Coordinati | Accessories

Finiture | Finishes



K 1203



- Orolucido
- Orsatin
- Ottone naturale
- Cromo
- Cromosat
- Anticato
- Bronzop
- Biancopaco
- Nikelnero



K 1202 Serie Trittico

Materiale Ottone | Material Brass

Coordinati | Accessories

Finiture | Finishes

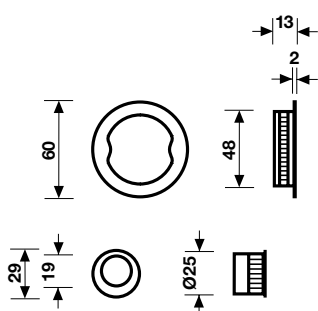

K 1202



- Orolucido
- Orsatin
- Ottone naturale
- Cromo
- Cromosat
- Anticato
- Brunito
- Bronzop
- Biancopaco
- Nikelnero

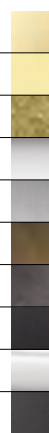

Coordinati | Accessories

Finiture | Finishes

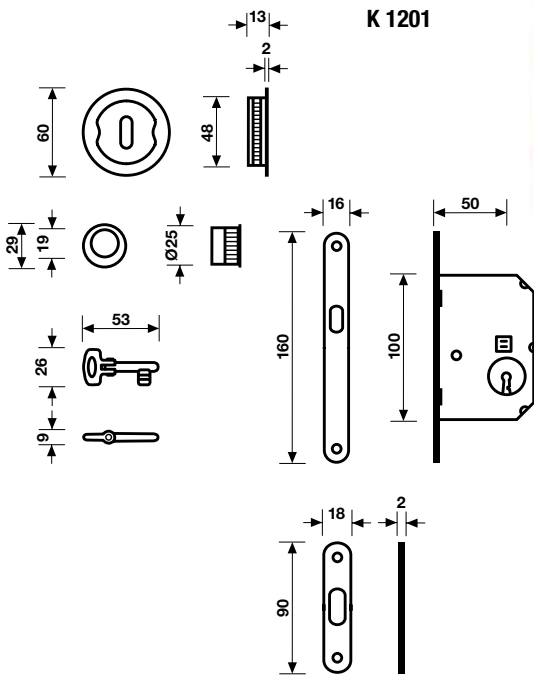

Orolucido	
Orsatin	
Cromo	
Cromosat	
Anticato	
Bronzop	
Biancopaco	
Nikelnero	

K 1200 Serie Trittico

Coordinati | Accessories

Finiture | Finishes

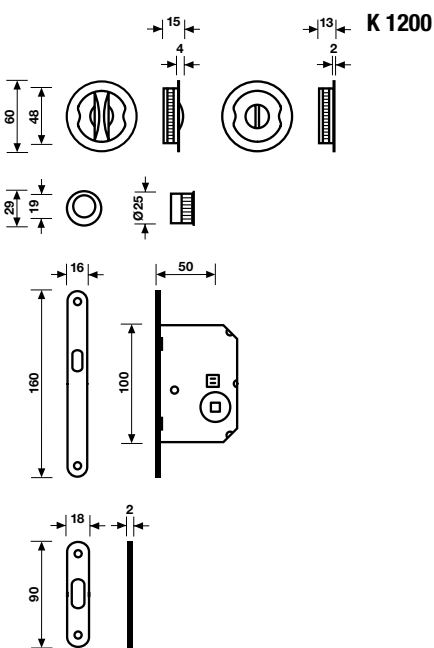

Orolucido	
Orsatin	
Ottone naturale	
Cromo	
Cromosat	
Anticato	
Brunito	
Bronzop	
Biancopaco	
Nikelnero	

Coordinati | Accessories

Finiture | Finishes

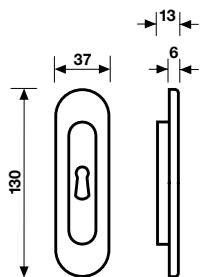

K 1186



Orolucido

Orsatin

Ottone naturale

Cromo

Cromosat

Anticato

Nikmatt

Brunito

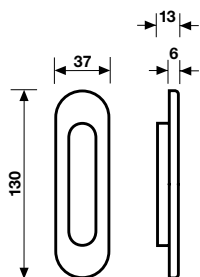

K 1186 SFC

K 1195

Coordinati | Accessories

Finiture | Finishes

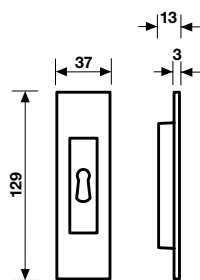

K 1195



Orolucido

Cromo

Cromosat

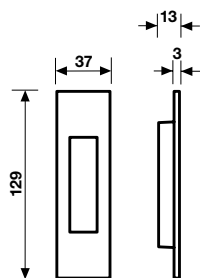

K 1195 SFC

Coordinati | Accessories

Finiture | Finishes

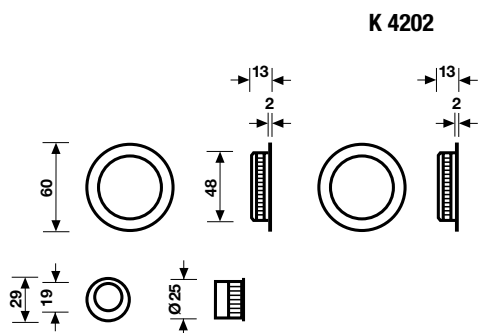

Orolucido

Cromosat



K 4200

Materiale Ottone | Material Brass

design Valli Workshop

Coordinati | Accessories

Finiture | Finishes

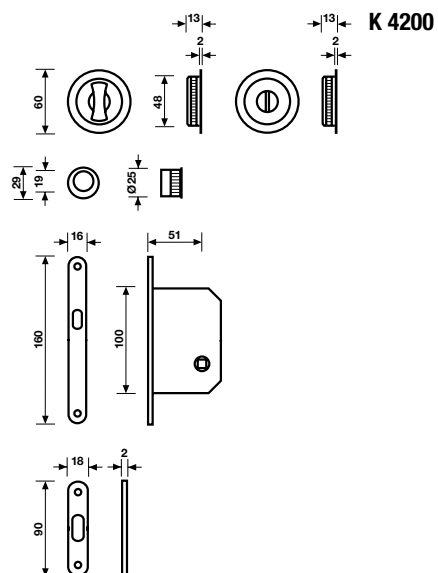

Orolucido

Cromosat



Chiusura privacy BZG | Bathroom privacy set **Finiture | Finishes**

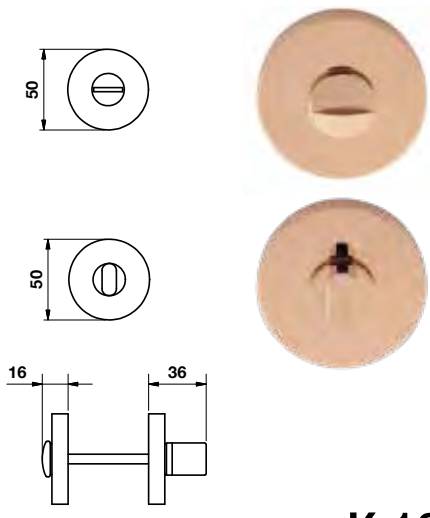

K 1867 R6-7-8 BZG

Metallo rame lucido

Metallo rame satinato



K 1867 RS

Chiusura privacy BZG | Bathroom privacy set **Finiture | Finishes**

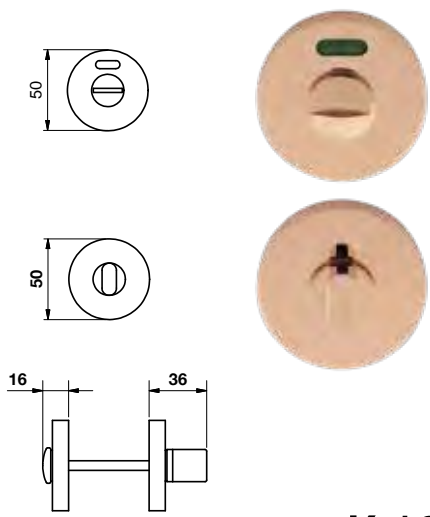

K 1867 RS6-7-8 BZG - 50

Metallo rame lucido

Metallo rame satinato



K 1865 B 50

Chiusura privacy BZG | Bathroom privacy set **Finiture | Finishes**

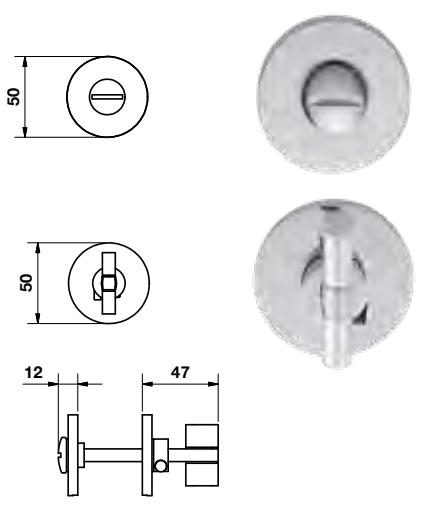

K1865 RB8 BZG - 50

Cromo

Cromosat

Nikelnero



K 1864 B 50

Materiale Acciaio C40 + Ottone | Material Steel C40 + Brass

design Valli Workshop

Chiusura privacy BZG | Bathroom privacy set

Finiture | Finishes

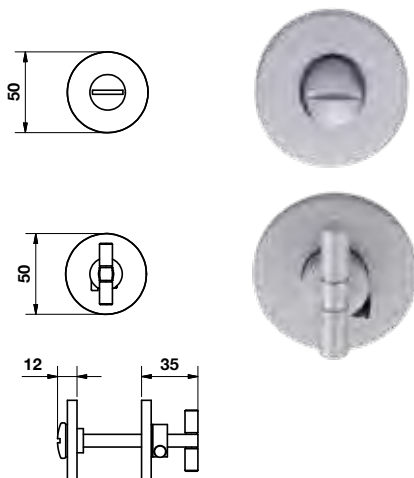

K1864 RB8 BZG - 50

Cromosat

Neropaco

Biancopaco



K 1229 RG

Materiale Ottone | Material Brass

design Valli Workshop

Chiusura privacy BZG | Bathroom privacy set

Finiture | Finishes

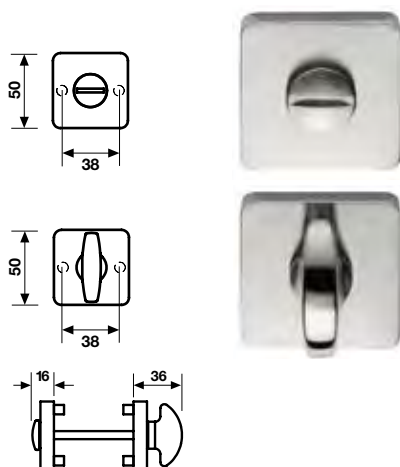

K 1229 RG6-7-8 BZG

Cromo

Cromosat

Light Black

Neropaco

Chiusura privacy BZG | Bathroom privacy set

Finiture | Finishes

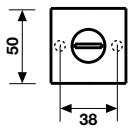

K 1225 RG6-7-8 BZG

Bronzsat

Cromo

Cromosat

Nikelnero

Neropaco

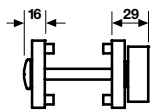
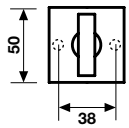

K 1123 RG

Materiale Ottone | Material Brass

design Valli Workshop

Chiusura privacy BZG | Bathroom privacy set

Finiture | Finishes

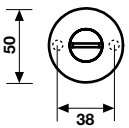

K 1123 RG6-7-8 BZG

Anticato

Brunito

Cromo

Cromosat

Orolucido

Orolux

Orsatin

Orsatop

Ottone A

Bronzop

Neropaco

Biancopaco

Ramematt

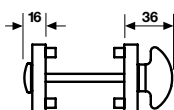
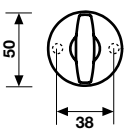

Chiusura privacy BZG | Bathroom privacy set

Finiture | Finishes

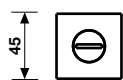

K 1740 R6-7-8 50 BZG - 85

Cromo

Cromosat

Neropaco

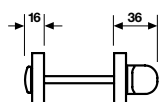
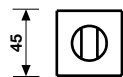

K 1704 R

Materiale Ottone | Material Brass

design Valli Workshop

Chiusura privacy BZG | Bathroom privacy set

Finiture | Finishes

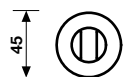

K 1704 R6-7-8 BZG - 85

Orolucido

Orsatin

Ottone naturale

Cromo

Cromosat

Anticato

Nikmatt

Bronzop

Brunito

Bronzsat

Orsatop

Neropaco

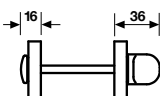
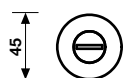

K 1704 RS

Materiale Ottone | Material Brass

design Valli Workshop

Chiusura privacy BZG | Bathroom privacy set

Finiture | Finishes

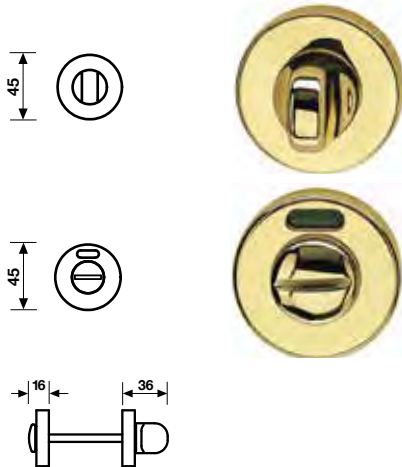

K 1704 RS6-7-8 BZG - 85

- Orolucido
- Cromo
- Cromosat
- Orsatop

K 1704 R 50

Materiale Ottone | Material Brass

design Valli Workshop

Chiusura privacy BZG | Bathroom privacy set

Finiture | Finishes

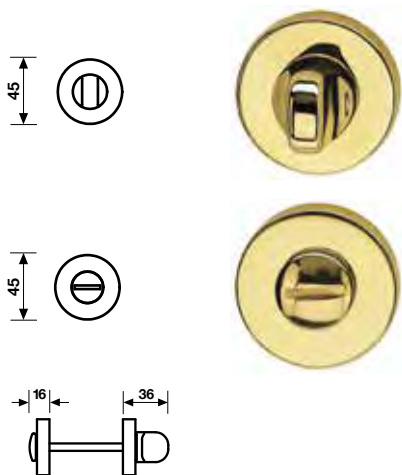

K 1704 R6-7-8 BZG - 50/85

- Orolucido
- Orsatop
- Cromo
- Cromosat
- Anticato
- Nikmatt
- Bronzop
- Bronzsat
- Neropaco
- Biancopaco
- Ramematt

K 1704 RS 50

Materiale Ottone | Material Brass

design Valli Workshop

Chiusura privacy BZG | Bathroom privacy set

Finiture | Finishes

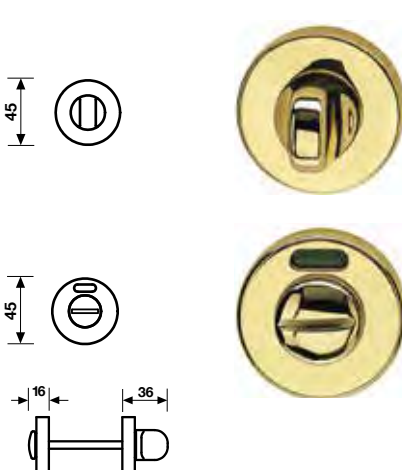

K 1704 RS6-7-8 BZG - 50/85

- Orolucido
- Orsatop
- Cromo
- Cromosat
- Anticato
- Nikmatt
- Bronzop
- Neropaco
- Biancopaco

Chiusura privacy BZG | Bathroom privacy set

Finiture | Finishes

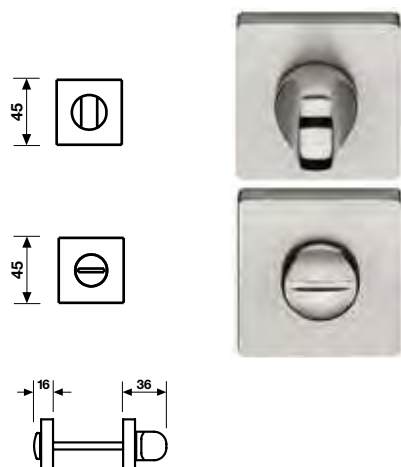

K 1233 R6-7-8 BZG - 85

- Cromo
- Cromosat
- Light Black
- Neropaco

K 1233 RS

Chiusura privacy BZG | Bathroom privacy set

Finiture | Finishes

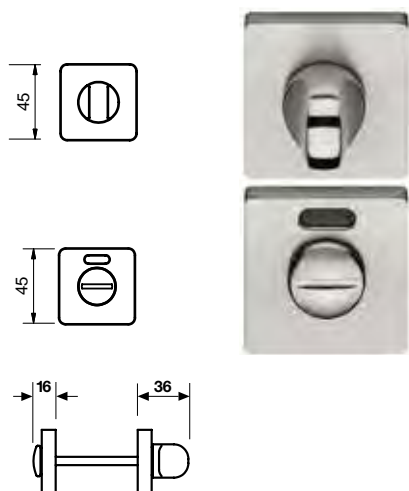

K 1233 RS6-7-8 BZG - 85

- Cromo
- Cromosat
- Light Black
- Neropaco

K 1225 R

Chiusura privacy BZG | Bathroom privacy set

Finiture | Finishes

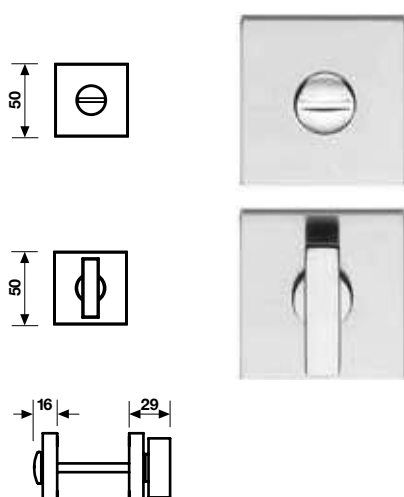

K 1225 R6-7-8 BZG - 75

- Cromo
- Cromosat
- Bronzsat
- Nikelnero
- Orantop



K 412

Materiale Acciaio Inox AISI 304 | Material Stainless Steel AISI 304

design Valli Workshop

Chiusura privacy BZG | Bathroom privacy set

Finiture | Finishes

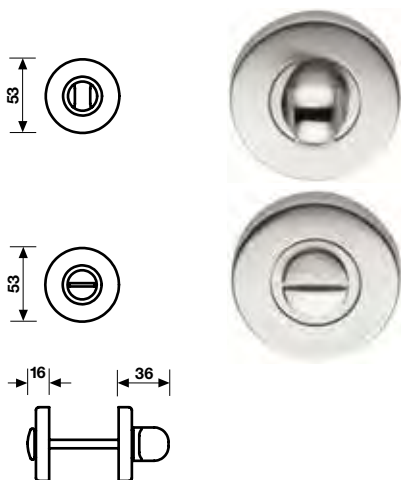

K 412 R6-7-8 50 BZG - 75

Satinato

K 411

Materiale Acciaio Inox AISI 304 | Material Stainless Steel AISI 304

design Valli Workshop

Chiusura privacy BZG | Bathroom privacy set

Finiture | Finishes

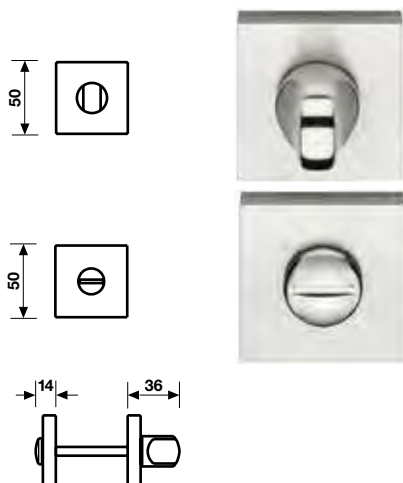

K 411 R6-7-8 50 BZG - 75

Satinato

K 43

Materiale Ottone | Material Brass

design Valli Workshop

Chiusura privacy BZG | Bathroom privacy set

Finiture | Finishes

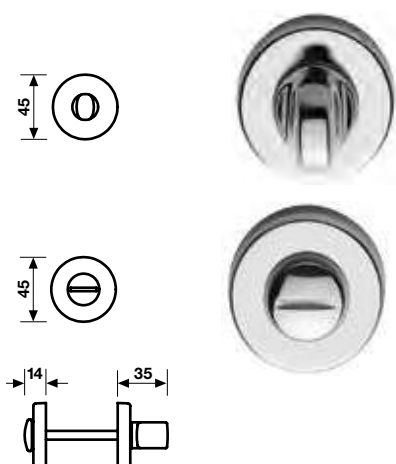

K 43 R6-7-8 50 BZG - 75

Orolucido

Orsatin

Cromo

Cromosat

Orolux

L 193

Materiale Ottone | Material Brass

design Valli Workshop

Coordinati | Accessories

Finiture | Finishes

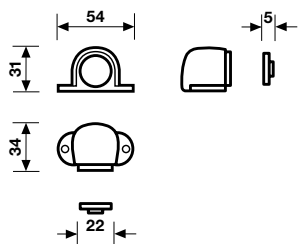

L 193



Orolucido

Cromo

Cromosat

Anticato



L 190

Materiale Ottone | Material Brass

design Valli Workshop

Coordinati | Accessories

Finiture | Finishes

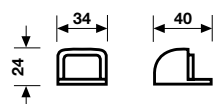

L 190



Orolucido

Cromo

Cromosat

Brunito



L 490

Materiale Acciaio Inox AISI 304 | Material Stainless Steel AISI 304

design Valli Workshop

Coordinati | Accessories

Finiture | Finishes

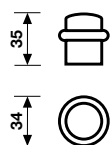

L 490



Satinato

Lucido



E 525

Materiale Nikrall Lega Zama UNI 3717 | Material Nikrall Lega Zama UNI 3717

design Valli Workshop

Coordinati | Accessories

Finiture | Finishes

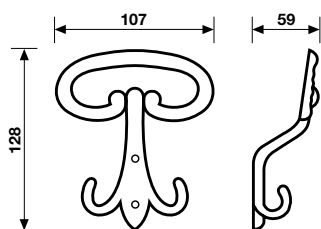

E 525



Patiné



E 183

Materiale Ottone | Material Brass

design Valli Workshop

Coordinati | Accessories

Finiture | Finishes

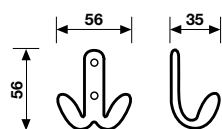

E 183



Orolucido

Cromo

Cromosat

Brunito



E 182

Materiale Ottone | Material Brass

design Valli Workshop

Coordinati | Accessories

Finiture | Finishes

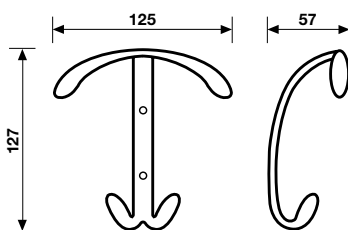

E 182



Orolucido

Cromo

Cromosat

Brunito



E 180

Materiale Ottone | Material Brass

design Cini Boeri

Coordinati | Accessories

Finiture | Finishes

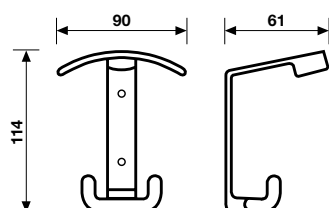

E 180



Orolucido

Cromosat



Informazioni tecniche | *Technical information*

Le informazioni tecniche
dei prodotti USA sono
consultabili alla sezione
"Documenti Tecnici"
sul sito **www.vallievalli.com**

*Technical information for
the USA product range can be
viewed under "Technical Documents"
at **www.vallievalli.com***

X 0610

Materiale Acciaio | Material Steel

Coordinati | Accessories

Finiture | Finishes

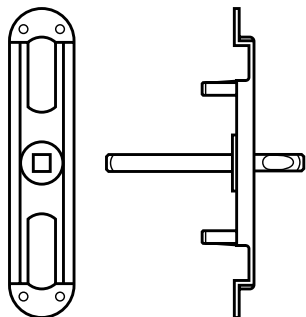

X 0610
Movimento
Movement
MP/7

Zincato

X 0609

Materiale Acciaio | Material Steel

Coordinati | Accessories

Finiture | Finishes

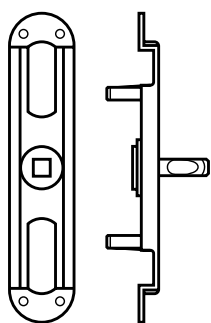

X 0609
Movimento
Movement
MP

Zincato

X 0607

Materiale Acciaio | Material Steel

Coordinati | Accessories

Finiture | Finishes

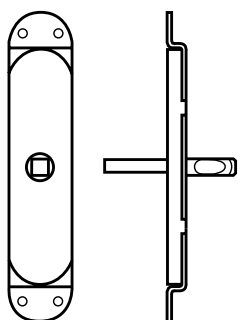

X 0607
Movimento
Movement
Martellina

Zincato

X 0606

Materiale Acciaio | Material Steel

Coordinati | Accessories

Finiture | Finishes

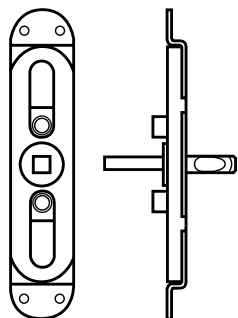

X 0606

Movimento
Movement
Gratz/7

Zincato

X 0605

Materiale Acciaio | Material Steel

Coordinati | Accessories

Finiture | Finishes

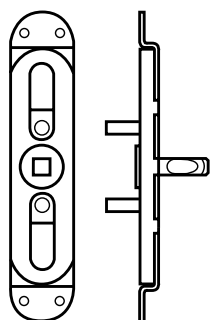

X 0605

Movimento
Movement
Gratz CP

Zincato

X 0604

Materiale Acciaio | Material Steel

Coordinati | Accessories

Finiture | Finishes

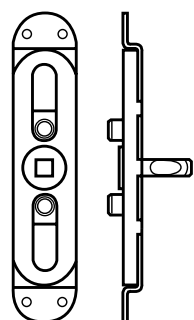

X 0604

Movimento
Movement
Gratz

Zincato

X 0601

Materiale Acciaio | Material Steel

Coordinati | Accessories

Finiture | Finishes

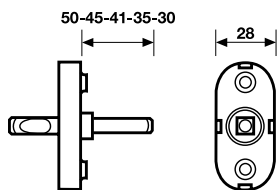

X 0601

Movimento
Movement
4 click position

Zincato

X 0608

Materiale Acciaio | Material Steel

Coordinati | Accessories

Finiture | Finishes

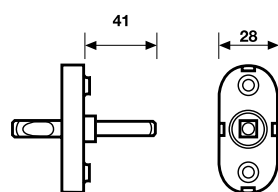

X 0608

Movimento
Movement
8 click position

Zincato

Sistemi di montaggio | Fixing system

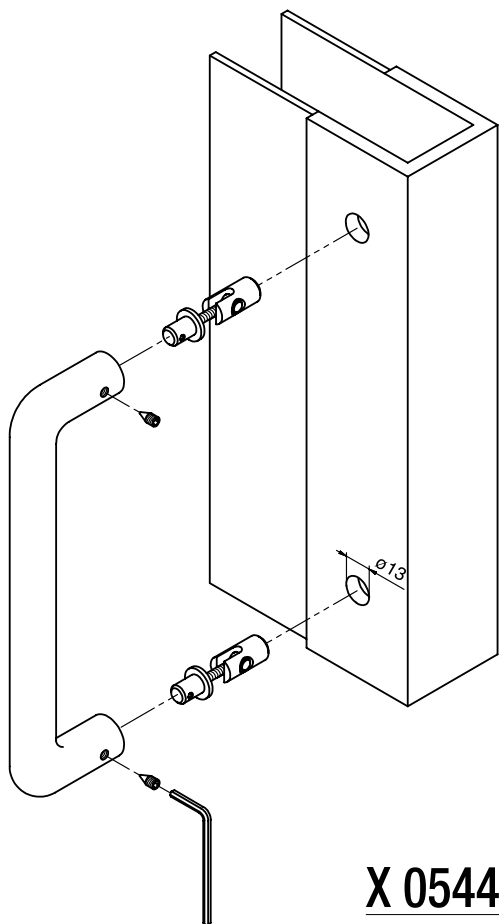

X 0551

Per fissaggio singolo maniglione senza
rosette coprivite su porta in alluminio, per art.
*For fixing a single pull handle without
screw-covering rosettes on an aluminium door, for art.*

K 1235 K 1231
K 1228 K 1226
K 1066 - K 1067 - K 1068
K 1061 K 1060
K 1057 K 1056
K 1055 K 1054

Diametro di foratura consigliato:
Recommended hole diameter: $\varnothing 13$ mm

X 0544

Sistemi di montaggio | Fixing system

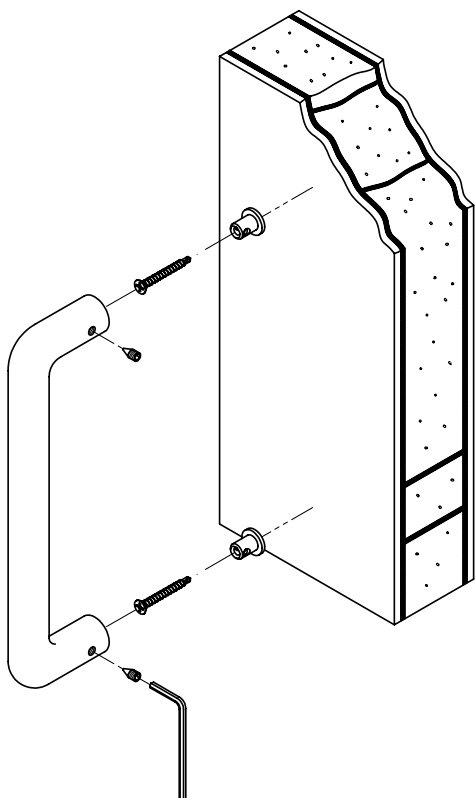

X 0544

Per fissaggio singolo maniglione senza
rosette coprivite su porta in alluminio, per art.
*For fixing a single pull handle without
screw-covering rosettes on an aluminium door, for art.*

K 1235 K 1231
K 1228 K 1226
K 1066 - K 1067 - K 1068
K 1061 K 1060
K 1057 K 1056
K 1055 K 1054

Sistemi di montaggio | Fixing system

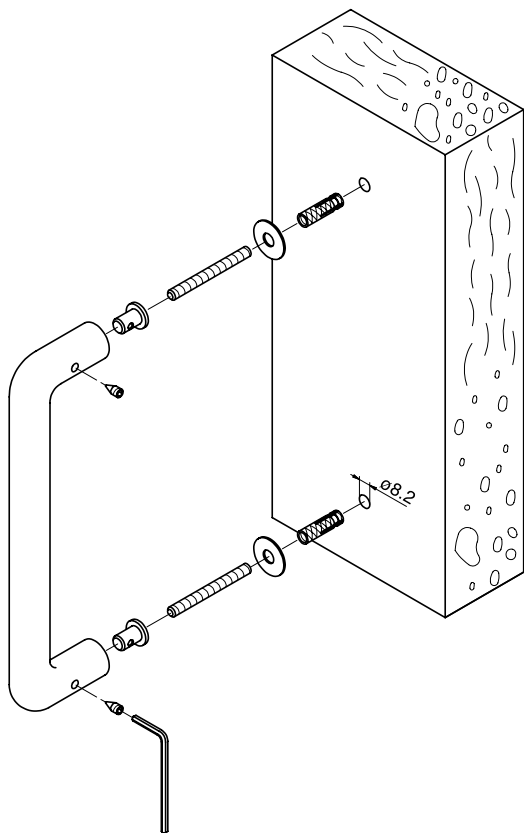

X 0531

Per fissaggio singolo maniglione senza rosette coprivite su porta legno o parete in muratura con bussola ad espansione in ottone per art.

For fixing a single pull handle without rosettes on a wooden door or on a masonry wall using a brass anchor screw for art.

K 1235 K 1231
K 1228 K 1226
K 1066 - K 1067 - K 1068
K 1061 K 1060
K 1057 K 1056
K 1055 K 1054

Diametro di foratura consigliato:

Recommended hole diameter: Ø 8.2 mm

X 0530

Sistemi di montaggio | Fixing system

Finiture | Finishes

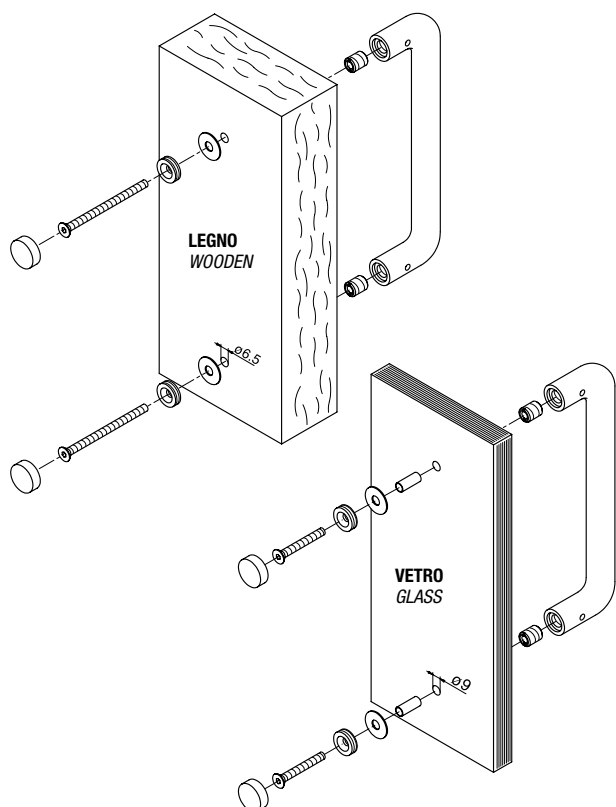

X 0530

Per fissaggio singolo maniglione senza osette coprivite su porta legno spessori:

For fixing a single pull handle without rosettes on a wooden door, thickness:
45÷55 mm
55÷65 mm

su porta vetro spessore:

on a glass door, thickness: 8÷12 mm

per art.

K 1235 K 1231
K 1228 K 1226
K 1066 - K 1067 - K 1068
K 1061 K 1060
K 1057 K 1056
K 1055 K 1054

Diametro di foratura consigliato

Recommended hole diameter:

porta legno/wooden door: Ø 6.5 mm

porta vetro/glass door: Ø 9 mm

Cromo

Cromosat

Orolucido

Anticato



Sistemi di montaggio | Fixing system

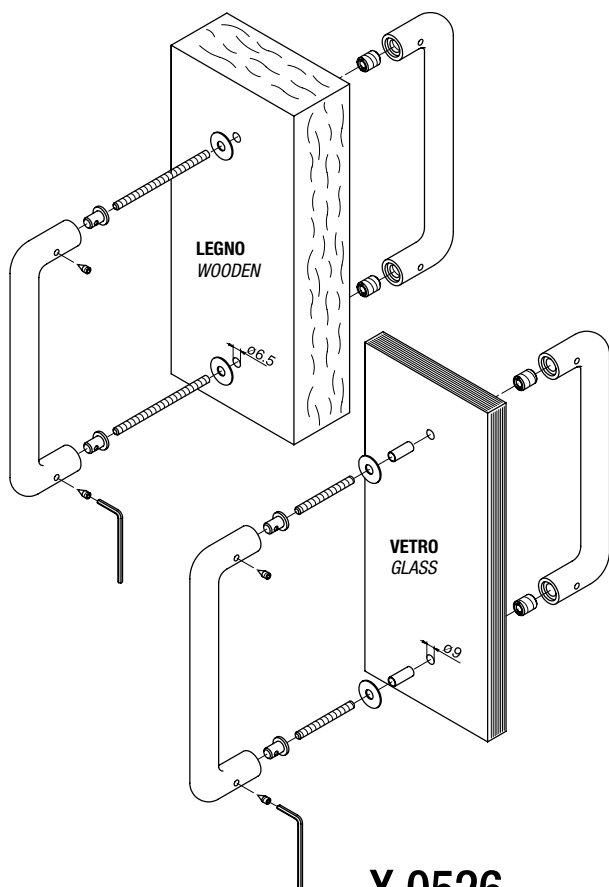

X 0528

Per fissaggio coppia maniglioni senza rosette coprivite su porta legno spessori:

For fixing a pair of pull handles without screw-covering rosettes on a wooden door, thickness:
45÷55 mm
55÷65 mm

su porta vetro spessore:
on a glass door, thickness: 8÷12 mm

per art.
K 1235 K 1231
K 1228 K 1226
K 1066 - K 1067 - K 1068
K 1061 K 1060
K 1057 K 1056
K 1055 K 1054

Diametro di foratura consigliato
Recommended hole diameter:
porta legno/wooden door: \varnothing 6.5 mm
porta vetro/glass door: \varnothing 9 mm

X 0526

Sistemi di montaggio | Fixing system

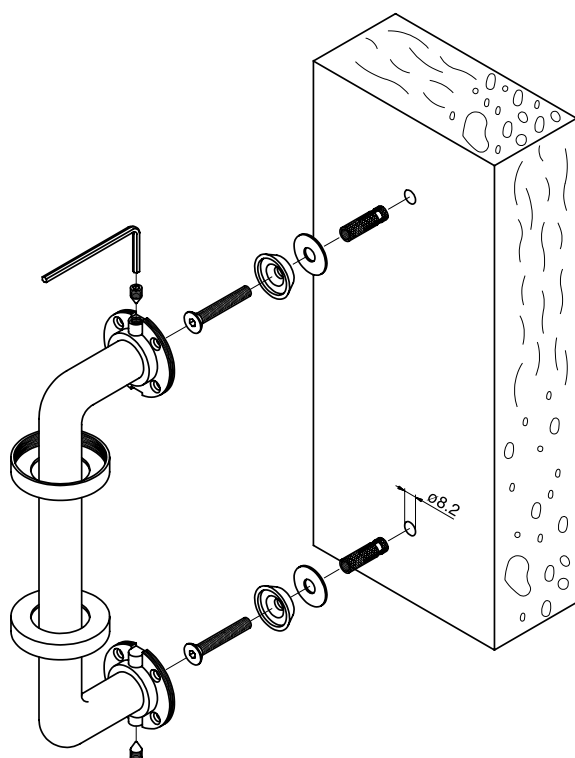

X 0526

Per fissaggio singolo maniglione con rosette coprivite su porta legni o parete in muratura con bussola ad espansione in ottone

For fixing a single pull handle without screw-covering rosettes on wooden door or on a masonry wall using a brass anchor screw

per art.
K 1210
K 1188

Diametro di foratura consigliato:
Recommended hole diameter: \varnothing 8.2 mm

Sistemi di montaggio | Fixing system

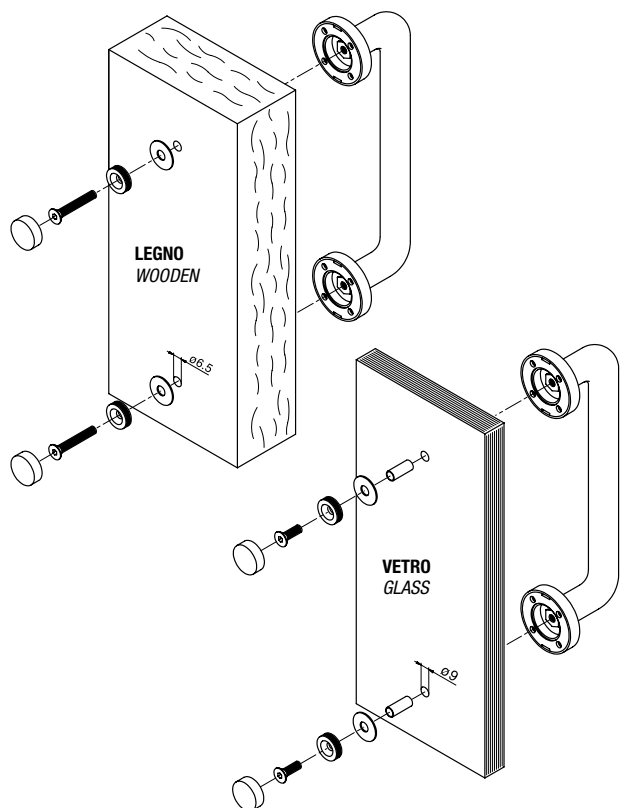

X 0525

**Per fissaggio singolo maniglione con rosette coprivite
su porta legno spessori:**

*For fixing a single pull handle with rosettes
on a wooden door, thickness:
45÷55 mm
55÷65 mm*

su porta vetro spessore:
on a glass door, thickness: 8÷12 mm

**per art.
K 1210
K 1188**

Diametro di foratura consigliato

*Recommended hole diameter:
porta legno/wooden door: Ø 6.5 mm
porta vetro/glass door: Ø 9 mm*

X 0523

Sistemi di montaggio | Fixing system

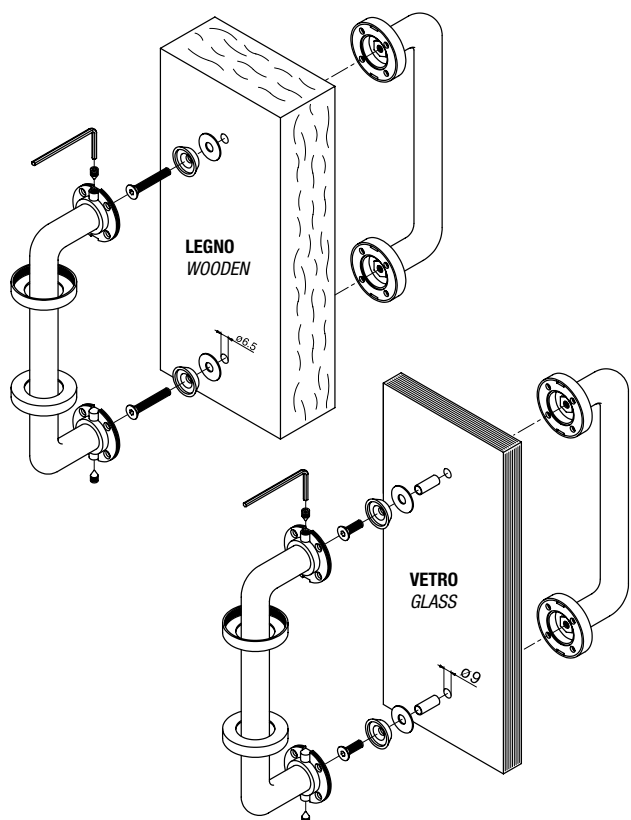

X 0523

**Per fissaggio singolo maniglione con rosette coprivite
su porta legno spessori:**

*For fixing a single pull handle with rosettes
on a wooden door, thickness:
45÷55 mm
55÷65 mm*

su porta vetro spessore:
on a glass door, thickness: 8÷12 mm

**per art.
K 1210
K 1188**

Diametro di foratura consigliato

*Recommended hole diameter:
porta legno/wooden door: Ø 6.5 mm
porta vetro/glass door: Ø 9 mm*

Sistemi di montaggio | Fixing system

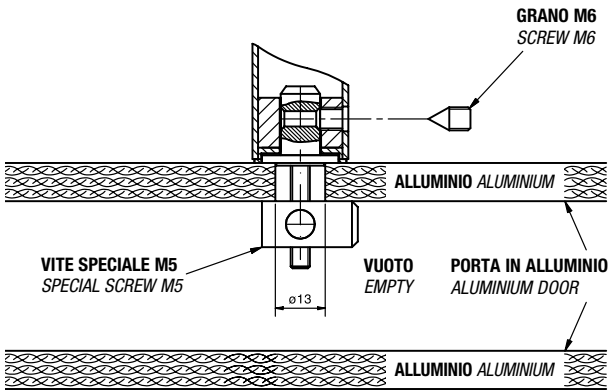

X 0552

Per fissaggio coppia maniglioni senza rosette coprivite su porta alluminio per art.
For fixing a single pull handle without screw-covering rosettes on an aluminium door, for art.

K 464 S
K 466 S

Diametro di foratura consigliato
Recommended hole diameter: $\varnothing 13\text{mm}$

X 0510

Sistemi di montaggio | Fixing system

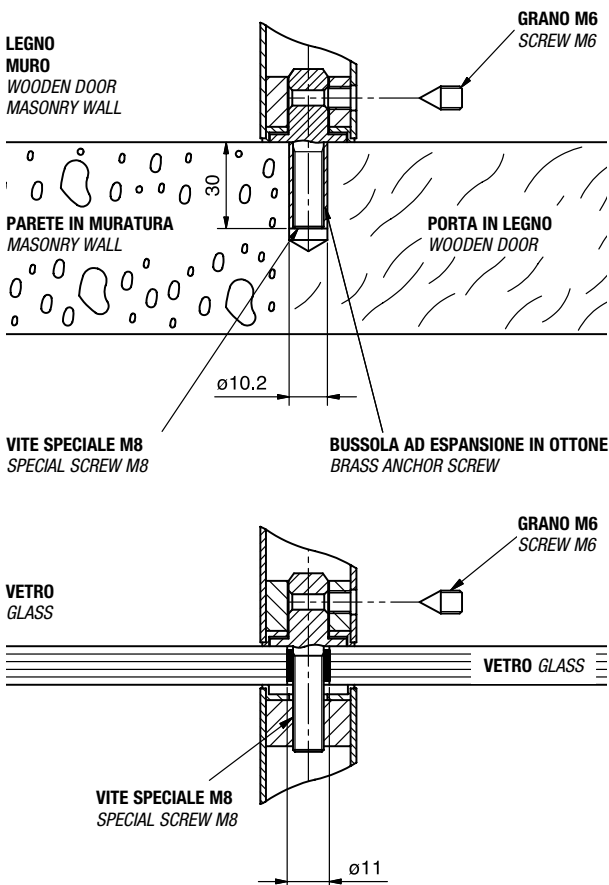

X 0510

Per fissaggio singolo maniglione su porta legno o parete in muratura con bussola ad espansione in ottone
For fixing a single pull handle on a wooden door or on a masonry wall using a brass anchor screw

per art.
K 464 S - K 466 S

Per fissaggio coppia maniglioni su porta vetro spessore: 8÷12 mm
For fixing a pair of pull handle on a glass door, thickness: 8÷12 mm

per art.
K 464 - K 464 S
K 466 - K 466 S

Diametro di foratura consigliato:
Recommended hole diameter:
porta legno/wooden door: $\varnothing 13\text{mm}$
porta vetro/glass door: $\varnothing 13\text{mm}$

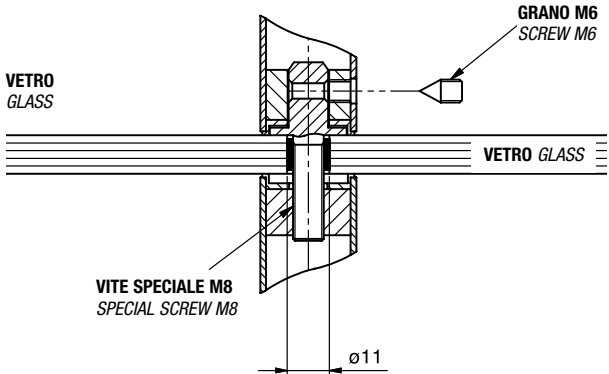

Sistemi di montaggio | Fixing system

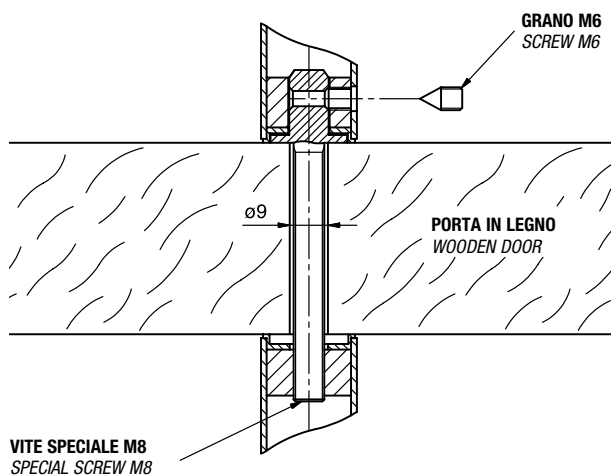

X 0509

Per fissaggio coppia maniglioni su porta legno spessori:

For fixing a single pull handle on a wooden door thickness:

45-60 mm

60-75 mm

75-90 mm

per art.

K 464 - K 464 S

K 466 - K 466 S

Diametro di foratura consigliato:

Recommended hole diameter: Ø 9mm

X 0508

Sistemi di montaggio | Fixing system

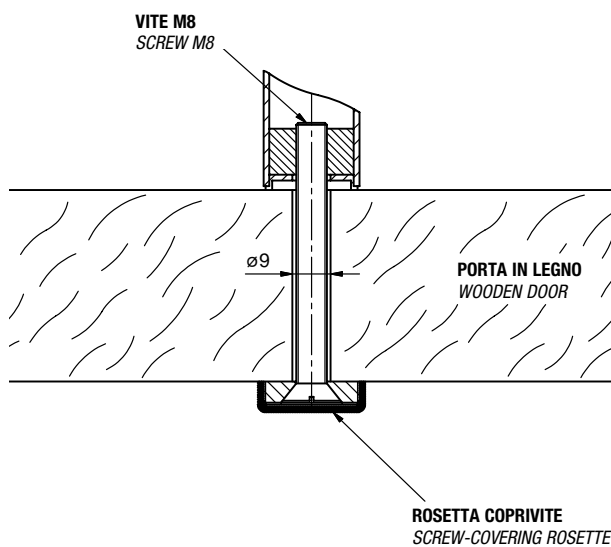

X 0508

per art.

K 464 - K 466

Sistemi di montaggio | Fixing system

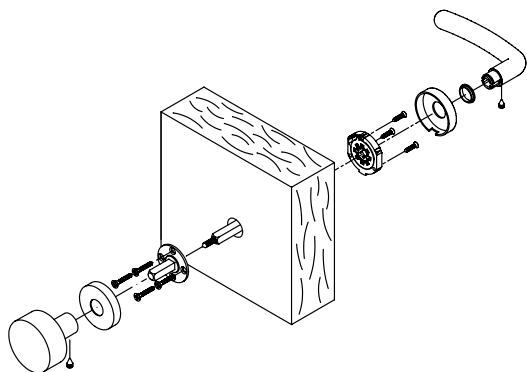

X 0519

**Per fissaggio pomolo fisso su serratura
in coppia con maniglia:**
*For fixing a fixed knob with operating lever
on taylor spindle*

per art.
K 1155
K 1166

X 0518

Sistemi di montaggio | Fixing system

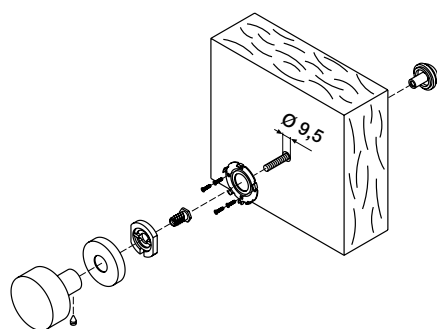

X 0518

**Per fissaggio pomolo singolo fisso con
dado/copridado passante**
*For fixing a single fixed knob
with through bolt/bolt-cover*

per art.
K 1155

Diametro di foratura consigliato:
Recommended hole diameter: Ø 9,5 mm

X 0517

Sistemi di montaggio | Fixing system

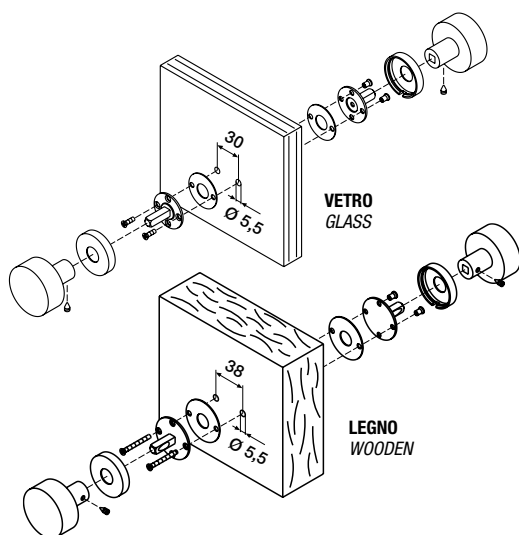

X 0517

**Per fissaggio pomoli fissi in coppia su vetro
spessore 8÷12 mm e su legno spessore 35÷43 mm**
*For fixing a pair of fixed knobs on glass,
thickness 8÷12 mm and on wood, thickness 35÷43 mm*

per art.
K 1155

Diametro di foratura consigliato:
Recommended hole diameter: Ø 5,5 mm

X 0516

Sistemi di montaggio | Fixing system

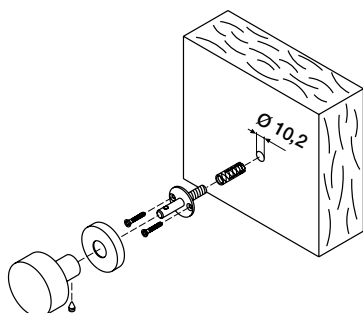

X 0516

Per fissaggio pomolo fisso singolo su porte in massello con bussola ad espansione in ottone
For fixing a single fixed knob on hardwood door using a brass anchor screw

per art.
K 1155, K 1153, K 1067, K 1061, K 1060,
K 1057, K 1056, K 1055, K 1054
K 1172, K 1171, K 1170

Diametro di foratura consigliato: *Recommended hole diameter:* Ø 10,2 mm

X 0514

Sistemi di montaggio | Fixing system

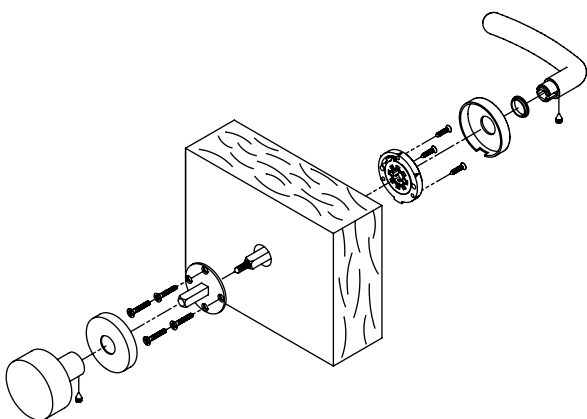

X 0514

Per fissaggio pomolo fisso su serratura in coppia con maniglia.
Utilizzo di quadro solidale a piastrina
For fixing a fixed knob with operating lever on taylor spindle

per art.
K 1155, K 1157, K 1067, K 1061
K 1060, K 1056, K 1055, K 1054,
K 1172, K 1171, K 1170

X 0513

Sistemi di montaggio | Fixing system

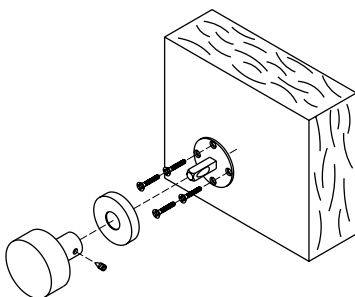

X 0513

Per fissaggio pomolo fisso singolo (su rosetta Ø 50) su porte con quadro solidale alla piastrina e viti a legno:
For fixing a single fixed knob on doors (on rosette Ø 50) with taylor spindle and wood screws

per art.
K 1153, K 1067, K 1061, K 1060, K 1057, K 1056
K 1055, K 1054, K 1172
K 1171, K 1170

Sistemi di montaggio | Fixing system

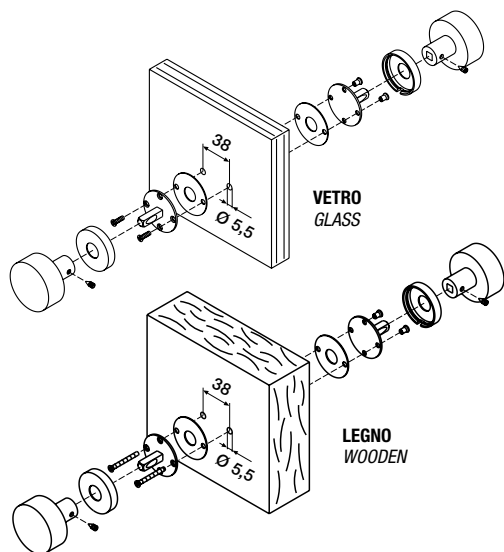

X 0512

Per fissaggio pomoli fissi in coppia su vetro spessore 8÷12 mm e su legno spessore 35÷43 mm
For fixing a pair of fixed knobs on glass, thickness 8÷12 mm and on wood, thickness 35÷43 mm

per art.
K 1153, K 1067, K 1061, K 1060, K 1057, K 1056
K 1055, K 1054, K 1172
K 1171, K 1170

Diametro di foratura consigliato:
Recommended hole diameter: Ø 5,5 mm

X 0511

Sistemi di montaggio | Fixing system

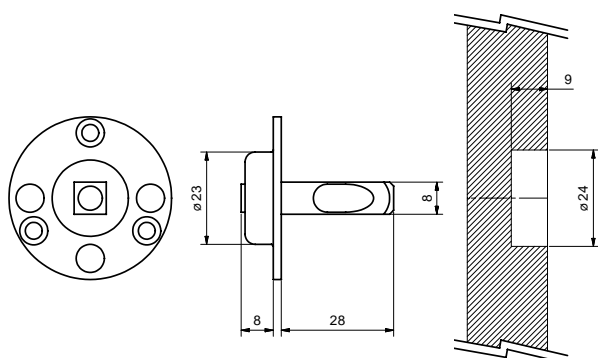

X 0511

Per fissaggio pomolo fisso senza foro passante
For fixing a fixed knob without through screw

Per fissaggio pomoli fissi su rosetta bassa
For fixing a pair of fixed knobs on slim rosette

X 0468/1 DX

Materiale Nikrall Lega Zama UNI 3717 e Nylon | Material Nikrall Lega Zama UNI 3717 and Nylon

Sistemi di montaggio | Fixing system

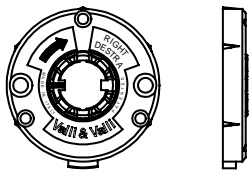

X 0468/1 DX

Sottorosetta con molla monodirezionale destra, diametro 50 mm, completa di viti per il fissaggio e bussola di centratura

Anchor rosette, with right directional spring, diameter 50 mm, complete of fixing screws and centering bush

X 0468/2 SX

Materiale Nikrall Lega Zama UNI 3717 e Nylon | Material Nikrall Lega Zama UNI 3717 and Nylon

Sistemi di montaggio | Fixing system

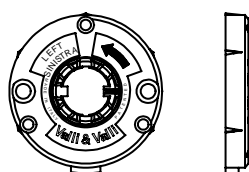

X 0468/2 SX

Sottorosetta con molla monodirezionale sinistra, diametro 50 mm, completa di viti per il fissaggio e bussola di centratura

Anchor rosette, with left directional spring, diameter 50 mm, complete of fixing screws and centering bush

X 0445/1 DX

Materiale Nikrall Lega Zama UNI 3717 e Nylon | Material Nikrall Lega Zama UNI 3717 and Nylon

Sistemi di montaggio | Fixing system

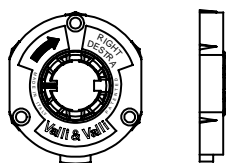

X 0445/1 DX

Sottorosetta con molla monodirezionale destra, diametro 45 mm, completa di viti per il fissaggio e bussola di centratura

Anchor rosette, with right directional spring, diameter 45 mm, complete of fixing screws and centering bush

X 0445/2 SX

Materiale Nikrall Lega Zama UNI 3717 e Nylon | Material Nikrall Lega Zama UNI 3717 and Nylon

Sistemi di montaggio | Fixing system

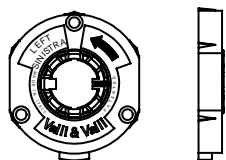

X 0445/2 SX

Sottorosetta con molla monodirezionale sinistra, diametro 45 mm, completa di viti per il fissaggio e bussola di centratura

Anchor rosette, with left directional spring, diameter 45 mm, complete of fixing screws and centering bush

X 0303

Materiale Acciaio | Material Steel

Sistemi di montaggio | Fixing system

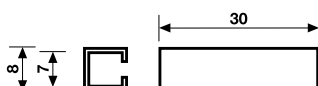

X 0303

Bussoletta
Adaptor Ø7

X 0209

Materiale Acciaio | Material Steel

Sistemi di montaggio | Fixing system

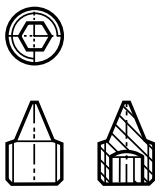

X 0209

Grano 6 MA x 9
Dowl 6 MA x 9

X 0208

Materiale Acciaio | Material Steel

Sistemi di montaggio | Fixing system



X 0208

Chiave esagonali
Hexagonal Keys
3 mm

X 0120

Materiale Acciaio | Material Steel

Sistemi di montaggio | Fixing system

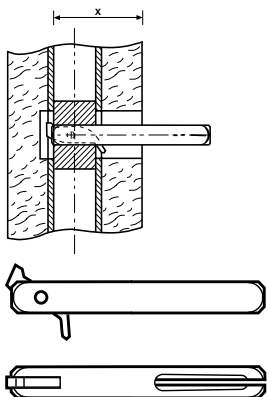

X 0120

Quadro block per porte forate solo da un lato
Block spindle for doors drilled on one side only \varnothing 8 mm

X 0110

Materiale Acciaio | Material Steel

Sistemi di montaggio | Fixing system

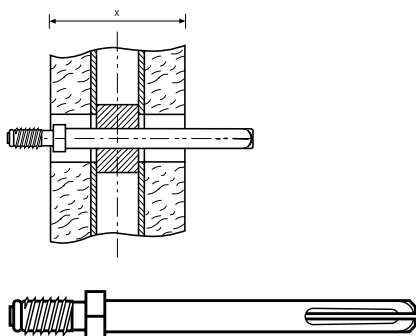

X 0110

Quadro con filetto per abbinamento maniglia-pomolo fisso
Threaded spindle for handle/fixed knob combination \varnothing 8 mm

X 0104

Materiale Acciaio | Material Steel

Sistemi di montaggio | Fixing system

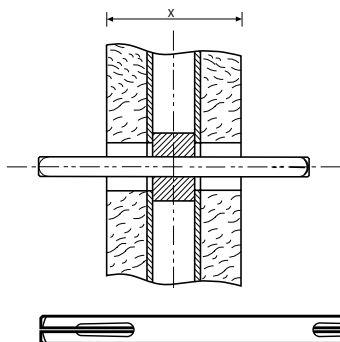

X 0104

Quadro tagliato
Slotted spindle
Ø 7 mm

X 0100/8

Materiale Acciaio | Material Steel

Sistemi di montaggio | Fixing system

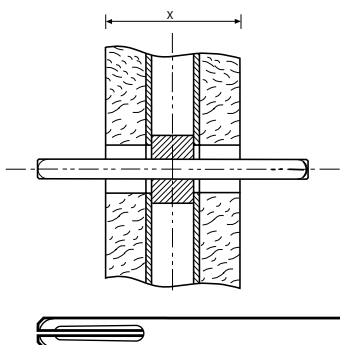

X 0100/8

Quadro tagliato
Slotted spindle
Ø 7 mm

X 4002

Materiale Acciaio | Material Steel

Sistemi di montaggio | Fixing system

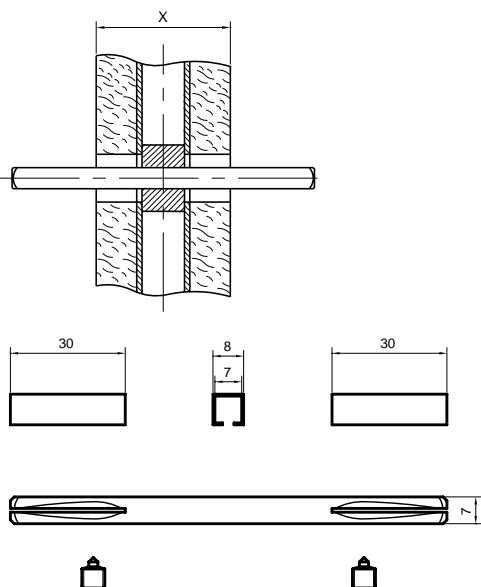

X 4002

**Kit componenti per coppia di maniglie da montare su porta
con serratura quadro 7 mm**
Handle pair kit for door with lockset spindle 7 mm

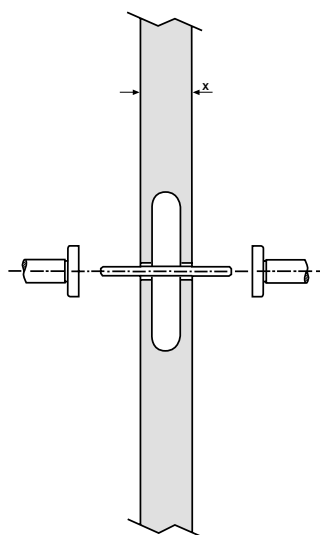

Maniglie per porta Door handles	Articolo Article	Serie Series	Spessore da Thickness from	A To	Con quadro With spindle
H 1068	Moon	32 mm	63 mm	8 x 114 mm	
H 1067	Rose	37 mm	52 mm	8 x 114 mm	
H 1066	Zeus	37 mm	52 mm	8 x 104 mm	
H 1065	Naked Due	38 mm	50 mm	8 x 155 mm	
H 1064	Naked	38 mm	50 mm	8 x 135 mm	
H 1062	Carmen	32 mm	63 mm	8 x 114 mm	
H 1061	Cenerentola	32 mm	63 mm	8 x 114 mm	
H 1060	Alina	37 mm	52 mm	8 x 104 mm	
H 1058	Amica	37 mm	52 mm	8 x 104 mm	
H 1057	Retrò	32 mm	63 mm	8 x 114 mm	
H 1056	Quadra	32 mm	63 mm	8 x 114 mm	
H 1055	Words	36 mm	52 mm	8 x 104 mm	
H 1054	W.W.	32 mm	63 mm	8 x 114 mm	
H 1052	Supersonic	32 mm	63 mm	8 x 114 mm	
H 1050	Giasone	32 mm	63 mm	8 x 114 mm	
H 1049	Divara	32 mm	63 mm	8 x 114 mm	
H 1046	Nais	32 mm	63 mm	8 x 114 mm	
H 1045	Bess	36 mm	62 mm	8 x 114 mm	
H 1044	Oberon	40 mm	55 mm	8 x 104 mm	
H 1044 Q	Oberon	40 mm	55 mm	8 x 104 mm	
H 1043	Alcina	35 mm	64 mm	8 x 114 mm	
H 1040	Siberia	32 mm	50 mm	8 x 104 mm	
H 1039	Fedra	27 mm	54 mm	8 x 104 mm	
H 1037	Teseo	38 mm	50 mm	8 x 104 mm	
H 1034	Polis	35 mm	64 mm	8 x 114 mm	
H 1027	Dafne	33 mm	55 mm	8 x 114 mm	
H 1026	Dido	33 mm	48 mm	8 x 96 mm	
H 1024	Lolita	30 mm	55 mm	8 x 114 mm	
H 1022	Ermani	37 mm	55 mm	8 x 114 mm	
H 1018	Otello	33 mm	57 mm	8 x 114 mm	
H 1016	Nabucco	37 mm	57 mm	8 x 114 mm	
H 1004	Antares	37 mm	43 mm	8 x 96 mm	
H 1003	Croco	33 mm	55 mm	8 x 114 mm	
H 914/8	Medicea	33 mm	55 mm	8 x 114 mm	
H 198	Mizar	33 mm	55 mm	8 x 114 mm	
H 192	Prunus	33 mm	55 mm	8 x 114 mm	
H 176	Spiga	33 mm	55 mm	8 x 114 mm	
H 165	Germana	33 mm	53 mm	8 x 114 mm	
H 163	Sarissa	33 mm	55 mm	8 x 114 mm	
H 123	Luigi XVI	39 mm	65 mm	8 x 114 mm	
H 4742	Coral	38 mm	52 mm	8 x 104 mm	
H 4730	White	30 mm	60 mm	8 x 114 mm	
H 4705	Rhodamine	30 mm	60 mm	8 x 114 mm	
H 419	Bordeaux	30 mm	60 mm	8 x 114 mm	
H 417	Indigo	30 mm	60 mm	8 x 114 mm	
H 416	Garnet	30 mm	60 mm	8 x 114 mm	
H 414	Amber	30 mm	60 mm	8 x 114 mm	

Pomoli per porta | *Door knobs*

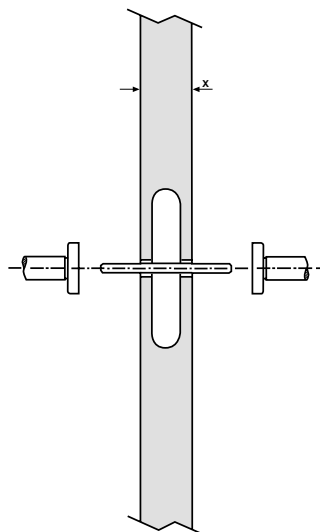

Articolo Article	Serie Series	Spessore da Thickness from	a to	con quadro with spindle
K 1067	Rose	42 mm	54 mm	8 x 96 mm
K 1061	Cenerentola	20 mm	55 mm	8 x 114 mm
K 1060	Alina	33 mm	45 mm	8 x 114 mm
K 1172		42 mm	54 mm	8 x 114 mm
K 1171		42 mm	54 mm	8 x 114 mm
K 1170		42 mm	54 mm	8 x 114 mm
K 1168		42 mm	54 mm	8 x 114 mm
K 1166		42 mm	54 mm	8 x 114 mm
K 1160		37 mm	50 mm	8 x 104 mm
K 1155 A		33 mm	50 mm	8 x 114 mm
K 1155		33 mm	50 mm	8 x 114 mm
K 1153		33 mm	50 mm	8 x 114 mm
K 1153 PY		33 mm	50 mm	8 x 114 mm
K 1730		33 mm	50 mm	8 x 114 mm
K 142		33 mm	50 mm	8 x 114 mm
K 1056	Quadra	42 mm	54 mm	8 x 96 mm
K 1055	Words	42 mm	54 mm	8 x 96 mm
K 1054	W.W.	42 mm	54 mm	8 x 96 mm
K 121	Luigi XVI	33 mm	47 mm	8 x 96 mm
K 465		30 mm	60 mm	8 x 114 mm

Maniglie per incasso | *Inset handles*

Articolo Article	Serie Series	Spessore da Thickness from	a to	con quadro with spindle
K 1230	Bess	34 mm	47 mm	6 x 40 mm
K 1211	Orfeide	34 mm	47 mm	6 x 37 mm
K 1204	Tancredi	36 mm	47 mm	6 x 40 mm
K 1200	Trittico	34 mm	47 mm	6 x 40 mm
K 4200		40 mm	53 mm	6 x 75 mm

Chiusure Privacy BZG | *Bathroom privacy sets*

Articolo Article	Serie Series	Spessore da Thickness from	a to	con quadro with spindle
K 1867		42 mm	52 mm	6 x 85 mm
K 1865		38 mm	50 mm	8 x 92 mm
K 1864		38 mm	50 mm	8 x 80 mm
K 1740		42 mm	52 mm	6 x 85 mm
K 1735		35 mm	45 mm	6 x 75 mm
K 1704		42 mm	52 mm	6 x 85 mm
K 1233		42 mm	52 mm	6 x 85 mm
K 1229		42 mm	52 mm	6 x 85 mm
K 1225		40 mm	46 mm	6 x 75 mm
K 1123		35 mm	45 mm	6 x 75 mm
K 412		38 mm	44 mm	6 x 75 mm
K 411		38 mm	44 mm	6 x 75 mm
K 43		38 mm	44 mm	6 x 75 mm



Per gli articoli su rosetta fine, il quadro è 10 mm inferiore allo standard in elenco

Please be aware that for all handles on slim rose, the spindle length is 10 mm less than the one indicated for standard handles

Per spessori porta diversi da quelli corrispondenti all'articolo, utilizzare quadri di lunghezze diverse presenti nel listino.

For door thickness outside the range covered by the standard spindle, select the spindle of the required length from those shown in the price list.

Programma kit porte blindate *Kits set for security doors*

Versione maniglia/pomolo su rosetta tonda | Version lever handle/knob on round rose

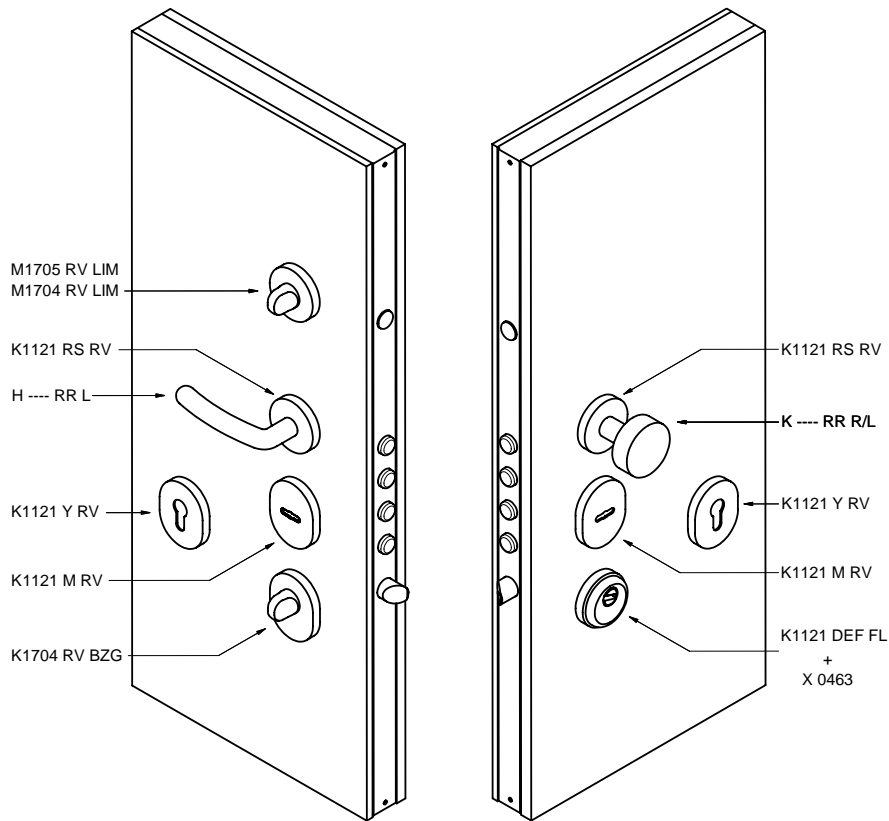

Versione maniglia/pomolo su rosetta tonda | Version lever handle/knob on round rose

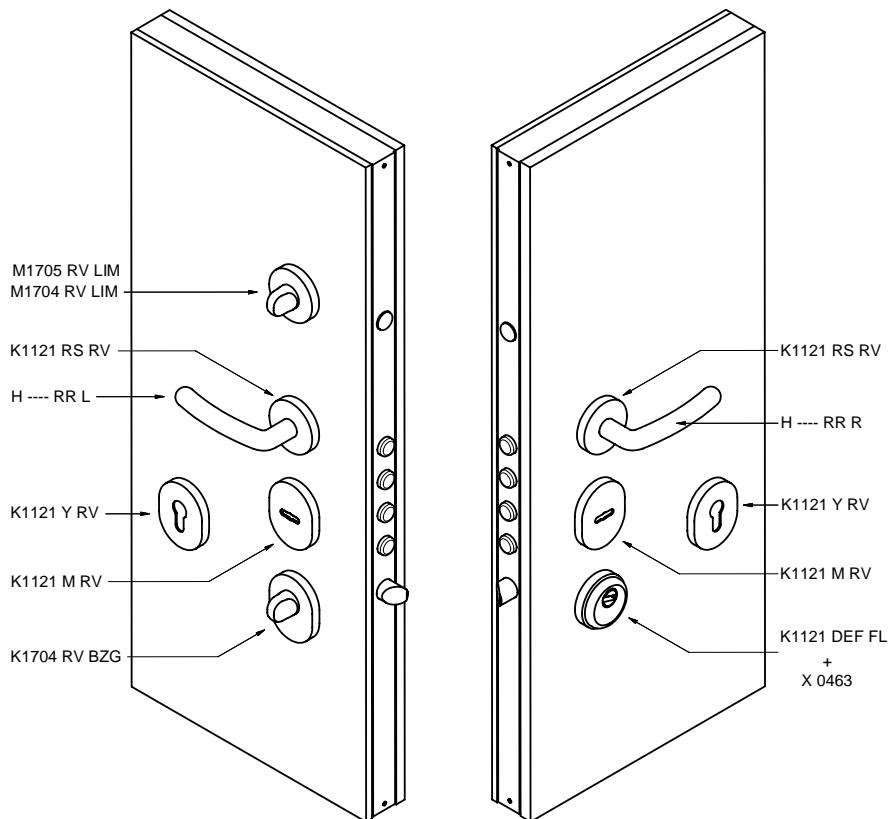

Versione maniglia/pomolo su rosetta quadra | Version lever handle/knob on square rose

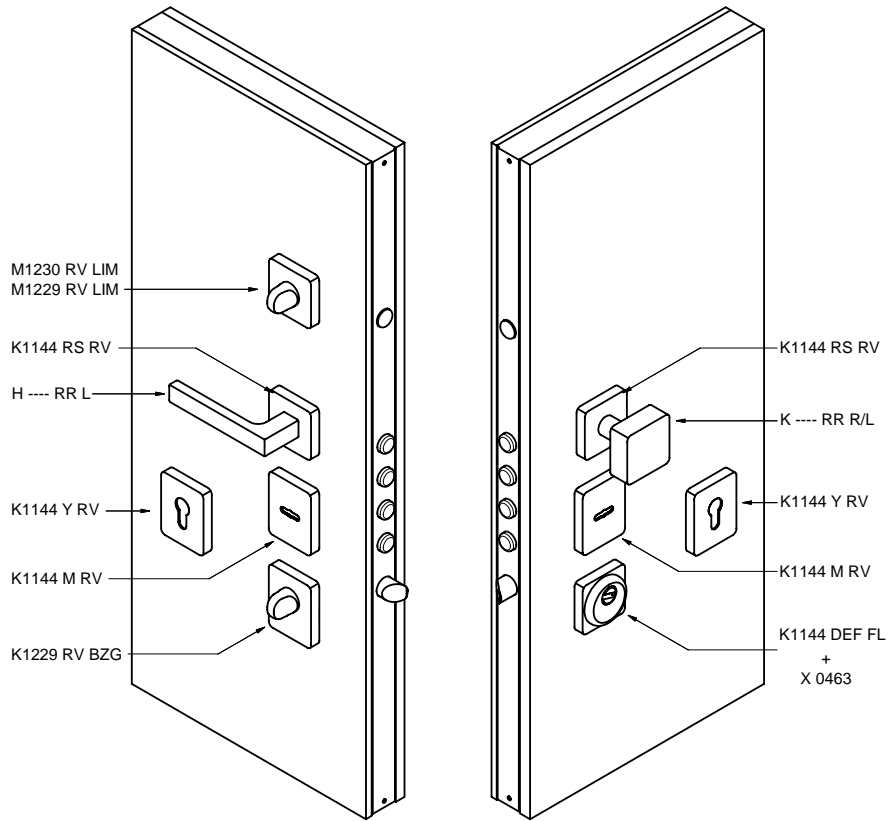

Versione maniglia/pomolo su rosetta quadra | Version lever handle/knob on square rose

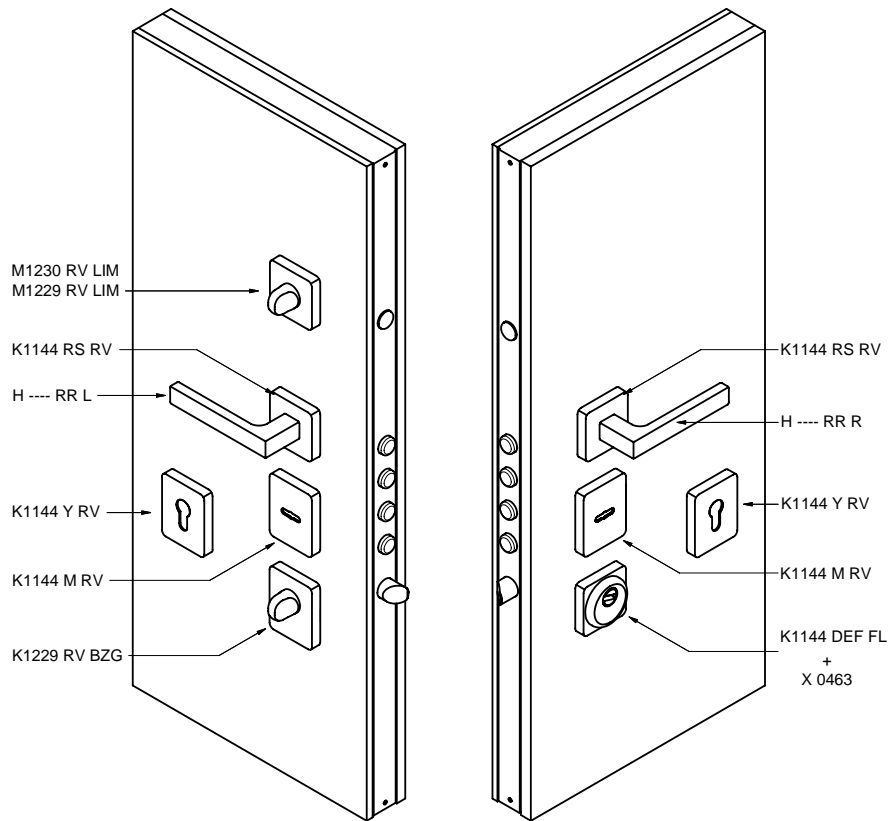

H RR L

Maniglie Sinistre | Left Handles

Codice Code	Finitura Finish
H 1068 RR L	Cromosat/Cromo
H 1068 RR L	Cromo
H 1068 RR L	Cromosat
H 1066 RR L	Cromosat
H 1062 RR L	Cromosat
H 1060 RR L	Cromosat
H 1060 RR L	Cromo
H 1058 RR L	Cromosat/Cromo
H 1057 RR L	Cromo
H 1056 RR L	Cromo
H 1055 RR L	Cromo/Neropaco
H 1055 RR L	Cromosat/Neropaco
H 1054 RR L	Cromo
H 1052 RR L	Cromo
H 1052 RR L	Cromosat
H 1050 RR L	Cromo
H 1050 RR L	Cromosat
H 1049 RR L	Cromo
H 1049 RR L	Cromosat
H 1046 RR L	Cromo
H 1046 RR L	Cromosat
H 1045 RR L	Cromo
H 1045 RR L	Cromosat
H 1044 RR L	Cromo
H 1044 RR L	Cromosat
H 1043 RR L	Cromo/Cromosat
H 1040 RR L	Cromosat
H 1040 RR L	Cromo
H 1039 RR L	Cromo/Cromosat
H 1027 RR L	Cromosat
H 1026 RR L	Cromo/Cromosat
H 1024 RR L	Cromo
H 1024 RR L	Cromosat
H 1022 RR L	Cromo/Cromosat
H 1018 RR L	Cromo/Cromosat
H 1016 RR L	Cromosat
H 1003 RR L	Cromosat
H 198 RR L	Cromosat
H 163 RR L	Cromo
H 163 RR L	Cromosat

H RR R

Maniglie Destre | Right Handles

Codice Code	Finitura Finish
H 1068 RR R	Cromosat/Cromo
H 1068 RR R	Cromo
H 1068 RR R	Cromosat
H 1066 RR R	Cromosat
H 1062 RR R	Cromosat
H 1060 RR R	Cromosat
H 1060 RR R	Cromo
H 1058 RR R	Cromosat/Cromo
H 1057 RR R	Cromo
H 1056 RR R	Cromo
H 1055 RR R	Cromo/Neropaco
H 1055 RR R	Cromosat/Neropaco
H 1054 RR R	Cromo
H 1052 RR R	Cromo
H 1052 RR R	Cromosat
H 1050 RR R	Cromo
H 1050 RR R	Cromosat
H 1049 RR R	Cromo
H 1049 RR R	Cromosat
H 1046 RR R	Cromo
H 1046 RR R	Cromosat
H 1045 RR R	Cromo
H 1045 RR R	Cromosat
H 1044 RR R	Cromo
H 1044 RR R	Cromosat
H 1043 RR R	Cromo/Cromosat
H 1040 RR R	Cromosat
H 1040 RR R	Cromo
H 1039 RR R	Cromo/Cromosat
H 1027 RR R	Cromosat
H 1026 RR R	Cromo/Cromosat
H 1024 RR R	Cromo
H 1024 RR R	Cromosat
H 1022 RR R	Cromo/Cromosat
H 1018 RR R	Cromo/Cromosat
H 1016 RR R	Cromosat
H 1003 RR R	Cromosat
H 198 RR R	Cromosat
H 163 RR R	Cromo
H 163 RR R	Cromosat

K 1171 RR R/L

Materiale Alluminio | Material Aluminium

Pomoli | Door knobs

Finiture | Finishes

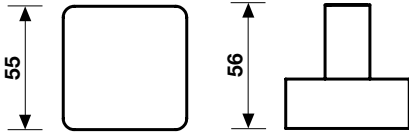

K 1171 RR R/L

Pomolo centrale
quadrato girevole o fisso
Round central
knob turning or fixed

Cromo

Cromosat

K 1170 RR R/L

Materiale Alluminio | Material Aluminium

Pomoli | Door knobs

Finiture | Finishes

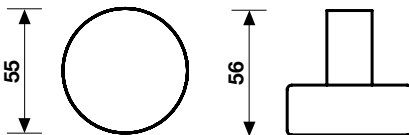

K 1170 RR R/L

Pomolo centrale
tondo girevole o fisso
Round central
knob turning or fixed

Cromo

Cromosat

K 1166

Materiale Nikrall Lega Zama UNI 3717 | Material Nikrall Lega Zama UNI 3717

Pomoli | Door knobs

Finiture | Finishes

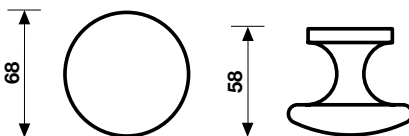

K 1166

Pomolo centrale
tondo fisso
Fixed central knob

Cromo

Cromosat

Orolucido - PVD

K 1121 RS RV

Materiale Ottone | Material Brass

Finiture | Finishes

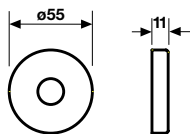

K 1121 RS RV
Rosetta tonda
Round rose

Cromo
Cromosat

M 1705 RV LIM

Materiale Ottone | Material Brass

Finiture | Finishes

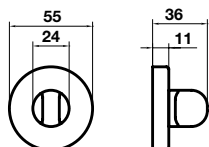

M 1705 RV LIM
Limitatore di apertura a
rotazione su rosetta tonda in abbinamento al
quadro X0462
Rotating safety catch on round rose coupled with
spindle X0462

Cromo
Cromosat

M 1704 RV LIM

Materiale Ottone | Material Brass

Finiture | Finishes

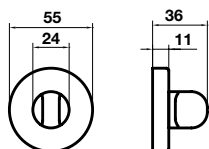

M 1704 RV LIM
Limitatore apertura a scorrimento su rosetta tonda
in abbinamento al perno X0464
Sliding safety catch couples
with pin X0464

Cromo
Cromosat

K 1704 RV BZG

Materiale Nikrall Lega Zama UNI 3717 | Material Nikrall Lega Zama UNI 3717

Finiture | Finishes

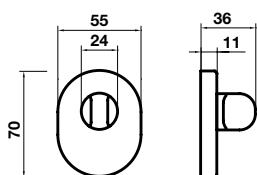

K 1704 RV BZG
Nottolino per cilindro su rosetta ovale
Thumbturn for cylinder on oval rose

Cromo
Cromosat

K 1121 Y RV

Materiale Nikrall Lega Zama UNI 3717 | Material Nikrall Lega Zama UNI 3717

Finiture | Finishes

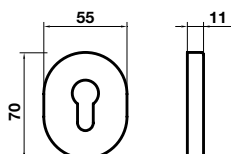

K 1121 Y RV
Bocchetta ovale foro cilindro
Oval cylinder escutcheon

Cromo
Cromosat

K 1121 M RV

Materiale Nikrall Lega Zama UNI 3717 | Material Nikrall Lega Zama UNI 3717

Finiture | Finishes

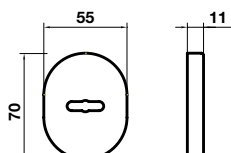

K 1121 M RV
Bocchetta ovale foro doppia mappa
Double bit lock hole oval escutcheon

Cromo
Cromosat

K 1121 DEF FL

Materiale Ottone | Material Brass

Finiture | Finishes

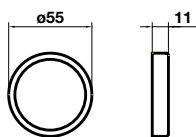

Rosetta tonda per defender
Defender round rose

K 1121 DEF FL

Cromo

Cromosat

K 1144 RS RV

Materiale Nikrall Lega Zama UNI 3717 | Material Nikrall Lega Zama UNI 3717

Finiture | Finishes

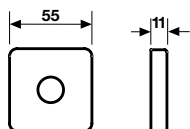

Rosetta quadra
Square rose

K 1144 RS RV

Cromo

Cromosat

M 1230 RV LIM

Materiale Nikrall Lega Zama UNI 3717 | Material Nikrall Lega Zama UNI 3717

Finiture | Finishes

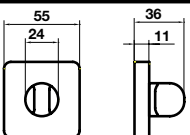

Limitatore di apertura a rotazione su rosetta quadra in abbinamento al quadro X0462
Rotating safety catch on square rose coupled with spindle X0462

M 1230 RV LIM

Cromo

Cromosat

M 1229 RV LIM

Materiale Nikrall Lega Zama UNI 3717 | Material Nikrall Lega Zama UNI 3717

Finiture | Finishes

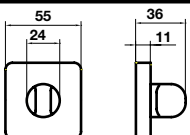

Limitatore apertura a scorrimento su rosetta quadra in abbinamento al perno X0464
Sliding safety catch on square rose coupled with pin X0464

M 1229 RV LIM

Cromo

Cromosat

K 1229 RV BZG

Materiale Nikrall Lega Zama UNI 3717 | Material Nikrall Lega Zama UNI 3717

Finiture | Finishes

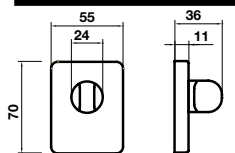

Nottolino per cilindro su rosetta rettangolare
Thumbturn for cylinder on rectangular rose

K 1129 RV BZG

Cromo

Cromosat

K 1144 Y RV

Materiale Nikrall Lega Zama UNI 3717 | Material Nikrall Lega Zama UNI 3717

Finiture | Finishes

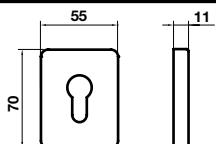

Bocchetta rettangolare foro cilindro
Rectangular cylinder escutcheon

K 1144 Y RV

Cromo

Cromosat

K 1144 M RV

Materiale Nikrall Lega Zama UNI 3717 | Material Nikrall Lega Zama UNI 3717

Finiture | Finishes

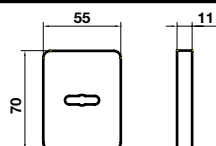

Bocchetta rettangolare foro doppia mappa
Double bit lock hole rectangular escutcheon

K 1144 M RV

Cromo

Cromosat

K 1144 DEF FL

Materiale Nikrall Lega Zama UNI 3717 | Material Nikrall Lega Zama UNI 3717

Finiture | Finishes

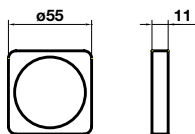

K 1144 DEF FL
Rosetta quadra per defender
Defender square rose

Cromo
Cromosat

X 0468/1

Materiale Nikrall Lega Zama UNI 3717 Nylon | Material Nikrall Lega Zama UNI 3717 Nylon

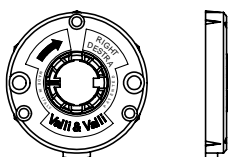

X 0468/1

Sottorosetta per porte blindate con molla monodirezionale destra, diametro 50 mm, completa di viti per il fissaggio e bussola di centratura, rondella di gomma e grano di fissaggio per la maniglia
Backplate for security doors with right-hand monodirectional spring 50 mm diameter complete of fixing screws and centering sleeve rubber washer and grub screw for handle

X 0468/2

Materiale Nikrall Lega Zama UNI 3717 Nylon | Material Nikrall Lega Zama UNI 3717 Nylon

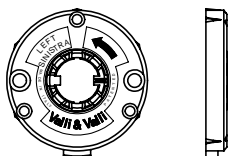

X 0468/2

Sottorosetta per porte blindate con molla monodirezionale destra, diametro 50 mm, completa di viti per il fissaggio e bussola di centratura, rondella di gomma e grano di fissaggio per la maniglia
Backplate for security doors with right-hand monodirectional spring 50 mm diameter complete of fixing screws and centering sleeve rubber washer and grub screw for handle

X 0468/3

Materiale Nikrall Lega Zama UNI 3717 | Material Nikrall Lega Zama UNI 3717

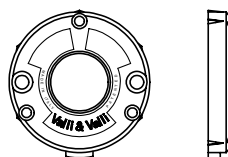

X 0468/3

Sottorosetta per porte blindate senza molla, diametro 50 mm, completa di viti per il fissaggio e bussola di centratura, rondella di gomma e grano di fissaggio per la maniglia
Backplate for security doors without spring 50mm diameter complete of fixing screws and centering sleeve rubber washer and grub screw for handle

X 0464

Materiale Acciaio | Material Steel

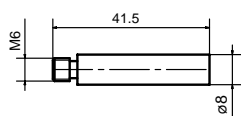

X 0464

Perno per limitatore di apertura
Pin for safety catch

X 0463

Materiale Acciaio ad alta resistenza temprato e zincato | Material High resistant steel hardened and galvanized

Finiture | Finishes

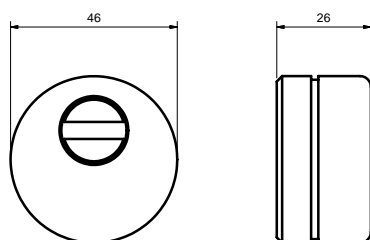

X 0463

Defender Ø46 mm

Cromo

Cromosat

Orolucido - PVD

X 0462

Materiale Acciaio X = da 45mm a 60mm | Material Steel X = from 45mm to 60mm

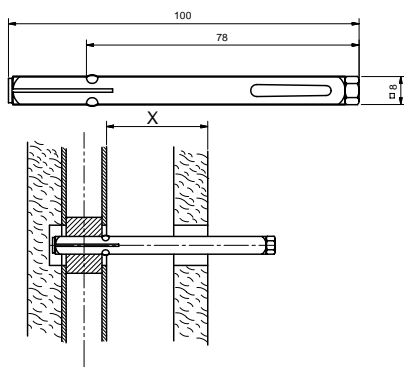

QX 0462

Quadro ad espansione per limitatore di apertura a rotazione
in combinazione con M1705 RV LIM e M1230RVLIM
Expansion spindle for rotating safety catch coupled with M1704 RV LIM and M1230 RV LIM

X 0519

Materiale Acciaio | Material Steel

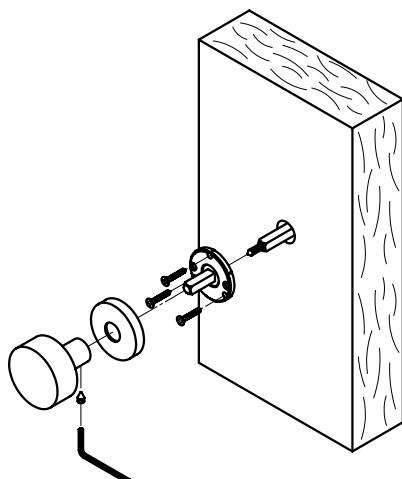

X 0519

Per fissaggio pomolo fisso su serratura in coppia con maniglia.
Utilizzo di quadro solidale a piastrina
For a back-to-back mounting on lock of a fixed knob with a door handle by using a Taylor spindle



Sistemi di fissaggio | Fixing versions available

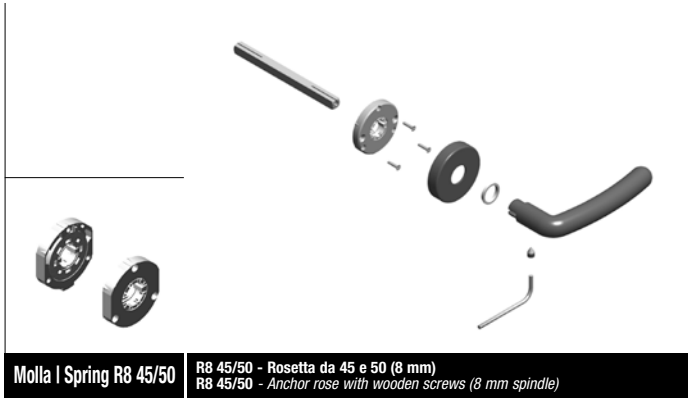
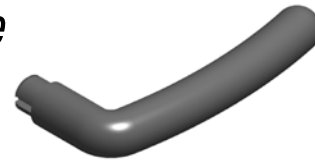

Molla | Spring R8 45/50
R8 45/50 - Rosetta da 45 e 50 (8 mm)
R8 45/50 - Anchor rose with wooden screws (8 mm spindle)

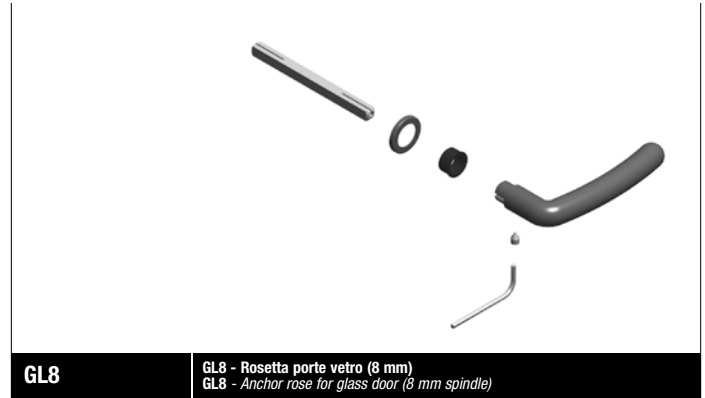

GL8
GL8 - Rosetta porte vetro (8 mm)
GL8 - Anchor rose for glass door (8 mm spindle)



Molla | Spring R08
R08 - Rosetta stretta (8 mm)
R08 - Narrow anchor rose with wooden screws (8 mm spindle)

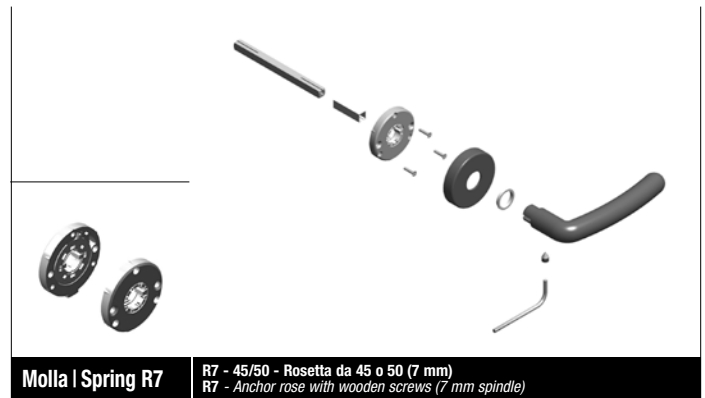

Molla | Spring R7
R7 - 45/50 - Rosetta da 45 o 50 (7 mm)
R7 - Anchor rose with wooden screws (7 mm spindle)



Molla | Spring RG8
RG8 - Rosetta da 50 e sottocostruzioni con viti passanti (8mm /8,5mm)
RG8 - Anchor rose for bolt through fixing (8 / 8,5 mm spindle)

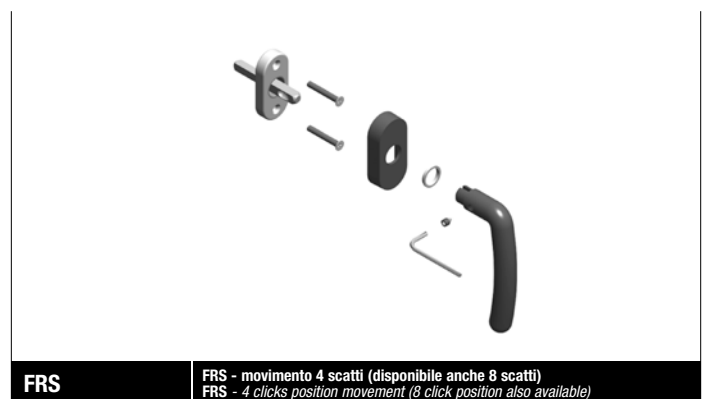

FRS
FRS - movimento 4 scatti (disponibile anche 8 scatti)
FRS - 4 clicks position movement (8 click position also available)

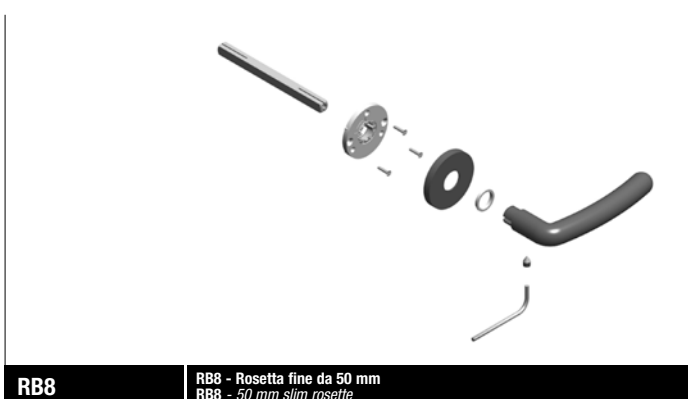

RB8
RB8 - Rosetta fine da 50 mm
RB8 - 50 mm slim rosette



FRS B
RG8 - movimento 8 scatti su rosetta fine
RG8 - 8 clicks position movement on slim rosette

Composizione codice prodotto | Composition of product code











Identificazione tipologia prodotto | Product type identification

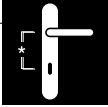

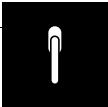
H	Maniglie per porta e per finestra Door handles and window handles
K	Pomoli per porta Door knobs
	Maniglioni Pull handles
	Bocchette Escutcheons
	Chiusure privacy BZG Bathroom privacy sets
M	Chiavi per porta Door keys
E	Portabiti Coat-hooks
	Ganci Hooks
X	Complementari e sistemi di fissaggio Complementary accessories and fixing systems

Descrizione parametri di identificazione articolo | Description of article identification parameters

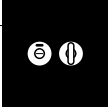
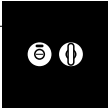
...R..		Articolo con rosetta, molla di ritorno e sottorosea con viti a legno, quadro 7 o 8 mm, bocchetta con foro chiave normale. Article on rosette with return spring and anchor rose with wooden screws, 7 or 8 mm spindle, with standard escutcheon.
...RB..		Articolo con rosetta fine, molla di ritorno e sottorosea con viti a legno, quadro 7 o 8 mm, bocchetta fine con foro chiave normale. Article on slim rosette with return spring and anchor rose with wooden screws, 7 or 8 mm spindle, with standard slim escutcheon.
...RR..R		Maniglia destra senza rosetta. Right handle without rosette.
...RR..L		Maniglia sinistra senza rosetta. Left handle without rosette.
...R..Y		Articolo con rosetta, molla di ritorno, sottorosea con viti a legno, quadro 7 o 8 mm, bocchetta con foro chiave cilindro. Article on rosette with return spring and anchor rose with wooden screws, 7 or 8 mm spindle, with cylinder escutcheon.
...RB..Y		Articolo con rosetta fine, molla di ritorno e sottorosea con viti a legno, quadro 7 o 8 mm, bocchetta fine con foro chiave cilindro. Article on slim rosette with return spring and anchor rose with wooden screws, 7 or 8 mm spindle, with cylinder slim escutcheon.
...R08..		Articolo con rosetta stretta, molla di ritorno e sottorosea con viti a legno, quadro 8 mm, bocchetta stretta con foro chiave normale. Article on narrow rose, with return spring, anchor rose with wooden screw, 8 mm spindle narrow escutcheon with normal key hole.
...R08..Y		Articolo con rosetta stretta, molla di ritorno e sottorosea con viti a legno, quadro 8 mm, bocchetta stretta con foro chiave cilindro. Article on narrow rose, with return spring, anchor rose with wooden screw, 8 mm spindle narrow escutcheon with cylinder key hole.
...RG..		Articolo con rosetta, molla di ritorno, sottorosea con perni per viti passanti, quadro 8 o 8,5 mm, bocchetta con foro chiave normale. Article on rosette with return spring and anchor rose for bolt through fixing, 8 or 8,5 mm spindle, with standard escutcheon.
...RGB..		Articolo con rosetta fine, molla di ritorno, sottorosea con perni per viti passanti, quadro 8 o 8,5 mm, bocchetta fine con foro chiave normale. Article on slim rosette with return spring and anchor rose for bolt through fixing, 8 or 8,5 mm spindle, with standard slim escutcheon.

...RG..Y		Articolo con rosetta, molla di ritorno, sottorosetta con perni per viti passanti, quadro 8 o 8,5 mm, bocchetta con foro chiave cilindro. <i>Article on rosette with return spring and anchor rose for bolt through fixing, 8 or 8,5 mm spindle, with cylinder escutcheon.</i>
...RGB..Y		Articolo con rosetta fine, molla di ritorno, sottorosetta con perni per viti passanti, quadro 8 o 8,5 mm, bocchetta fine con foro chiave cilindro. <i>Article on slim rosette with return spring and anchor rose for bolt through fixing, 8 or 8,5 mm spindle, with cylinder escutcheon.</i>
...P .. 70*		Articolo con placca, quadro 7-8-8,5 mm, foro chiave normale. Il numero 70, indicato a titolo di esempio, che è variabile e dipende dalle normative di ogni mercato, indica l'interasse in mm tra foro chiave e foro maniglia. <i>Article on plate, 7-8-8,5 mm spindle, standard keyhole. The number "70" shown is variable and depends on the requirements of each individual market. It indicates distance between the spindle and keyhole centre in mm.</i>
...P .. Y 85*		Articolo con placca, quadro 7-8-8,5 mm, foro chiave cilindro. Il numero 85, indicato a titolo di esempio, che è variabile e dipende dalle normative di ogni mercato, indica l'interasse in mm tra foro chiave e foro maniglia. <i>Article on plate, 7-8-8,5 mm spindle, cylinder keyhole. The number "85" shown is variable and depends on the requirements of each individual market. It indicates distance between the spindle and keyhole centre in mm.</i>
...F		Maniglia per finestra. <i>Window handle.</i>
...F RS		Maniglia per finestra con movimento DRY-KEEP 4 e/o 8 scatti, disponibile con lunghezza quadro 27-30-35-41-45-50 mm. <i>Window handle with DRY-KEEP movement, 4/8 click positions, available with spindle lengths 27-30-35-41-45-50 mm.</i>
...F RS B		Maniglia per finestra con movimento DRY-KEEP 8 scatti, su rosetta fine disponibile con lunghezza 41 mm. <i>Window handle with DRY-KEEP movement, 8 click positions on slim rosette, available with 41 mm spindle length.</i>
...R 6-7-8 BZG		Chiusura privacy, quadro disponibile 6-7-8 mm e lunghezza 75-85 mm, sottorosetta con viti a legno. <i>Bathroom privacy set, 6-7-8 mm diameter spindle with length of 75-85 mm. Anchor rose with wood screws.</i>
...RG 6-7-8 BZG		Chiusura privacy, quadro disponibile 6-7-8 mm e lunghezza 75-85 mm, sottorosetta con viti passanti. <i>Bathroom privacy set, 6-7-8 mm diameter spindle with length of 75-85 mm. Anchor rose with through screws.</i>
...RS 6-7-8 BZG		Chiusura privacy, quadro disponibile 6-7-8 mm e lunghezza 75-85 mm, sottorosetta con viti a legno, con indicatore libero/occupato. <i>Bathroom privacy set, 6-7-8 mm diameter spindle with length of 75-85 mm. Anchor rose with wood screws. Vacant/engaged indicator</i>
...RSG 6-7-8 BZG		Chiusura privacy, quadro disponibile 6-7-8 mm e lunghezza 75-85 mm, sottorosetta con viti passanti, con indicatore libero/occupato. <i>Bathroom privacy set, 6-7-8 mm diameter spindle with length of 75-85 mm. Anchor rose with through screws. Vacant/engaged indicator</i>
...GL		Maniglia per serratura porte vetro. <i>Door handle suitable for glass door locks.</i>

Le maniglie in elenco rispondono alla **Norma Europea EN 1906:2012** | *Below listed handles meet the European Norm EN 1906:2012*

- 1** Sono certificate in **CLASSE 4** | *Class 4 certified*
- 2** **Durabilità** | *Durability*
- 3** **Performance elevate oltre 200.000 cicli di apertura** | *High performance: over 200.000 opening cycles*
- 4** **Elevata resistenza alla corrosione** | *High resistance to corrosion*
- 5** **Con molla di ritorno** | *With return spring*

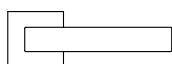

H 1068

Serie **Moon**
pag.08

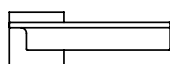

H 1060

Serie **Alina**
pag.19



H 1057

Serie **Retrò**
pag.23

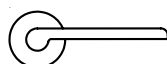

H 1054

Serie **W.W.**
pag.30

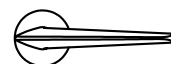

H 1052

Serie **Supersonic**
pag.32

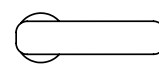

H 1050

Serie **Giasone**
pag.34

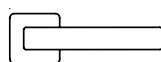

H 1049

Serie **Divara**
pag.38



H 1046

Serie **Nais**
pag.42

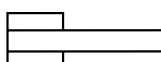

H 1045

Serie **Bess**
pag.44

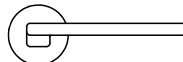

H 1044 U

Serie **Oberon**
pag.48



H 1044 Q U

Serie **Oberon**
pag.51



H 1039

Serie **Fedra**
pag.56



H 1027

Serie **Dafne**
pag.60

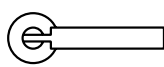

H 1026

Serie **Dido**
pag.61

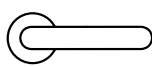

H 1024

Serie **Lolita**
pag.63

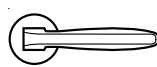

H 1022

Serie **Ernani**
pag.65

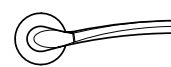

H 1018

Serie **Otello**
pag.67



H 1016

Serie **Nabucco**
pag.68



H 1003

Serie **Croco**
pag.71



H 198

Serie **Mizar**
pag.75

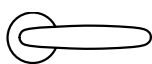

H 192

Serie **Prunus**
pag.78



H 165

Serie **Germana**
pag.82

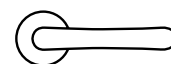

H 163

Serie **Sarissa**
pag.84

NOTE:



Disponibile anche **CLASSE 4** su **R8 CL4 - R8 Y CL4 - RG8 CL4 - RG8 Y CL4** secondo la norma **DIN EN 1906 - Digit 4 7 - 0 0 - 0 B**
Available also **CLASS 4** on **R8 CL4 - R8 Y CL4 - RG8 CL4 - RG8 Y CL4** according to the **DIN Standard EN 1906 - Digit 4 7 - 0 0 - 0 B**

Prezzo da richiedere | Price upon request

4
7
-
0
0
-
0
B

1
2
3
4
5
6
7
8

Descrizione Description	Classe Class	Significato delle classi Class meaning
---------------------------	----------------	--

1 Categoria di utilizzo <i>Category of use</i>	1	Classe 1	Utilizzo di media frequenza delle guarniture, da parte di persone che sostanzialmente esercitano un utilizzo accurato e presentano un rischio ridotto per quanto riguarda l'uso non corretto (ad esempio per le porte interne di abitazioni). <i>Medium frequency of use by people with a high incentive to exercise care and with a small chance of misuse, e.g. internal residential doors.</i>
	2	Classe 2	Utilizzo di media frequenza delle guarniture, da parte di persone che esercitano un utilizzo sostanzialmente accurato ma che presentano un certo rischio per quanto riguarda l'uso non corretto (ad esempio per le porte interne di uffici). <i>Medium frequency of use by people with some incentive to exercise care but where there is some chance of misuse, e.g. internal office doors.</i>
	3	Classe 3	Utilizzo ad elevata frequenza delle guarniture, da parte del pubblico o di altre persone, che non hanno particolare cura nell'uso e per le quali esiste un notevole rischio d'utilizzo errato (ad esempio per le porte di edifici pubblici notevolmente frequentati). <i>High frequency of use by public or others with little incentive to exercise care and with a high chance of misuse, e.g. public office doors.</i>
	4	Classe 4	Per impiego su porte che vengono azionate spesso e con forza (porte in stadi di calcio, su piattaforme petrolifere, nelle caserme, toilette pubbliche, ...). <i>High frequency of use on doors which are subject to frequent violent usage, e.g. football stadiums, offshore installations (oil rigs), barracks, public toilets, etc.</i>
2 Resistenza di durata <i>Durability</i>	6	100.000 cicli di prova <i>test runs</i>	
	7	200.000 cicli di prova <i>test runs</i>	
3 Massa della porta <i>Door mass</i>	-	-	
4 Resistenza al fuoco <i>Fire resistance</i>	0	non ammissibile per porte tagliafuoco o antifumo <i>not allowed for fire doors or anti-smoking doors</i>	
	1	adatta per porte tagliafuoco ed antifumo <i>suitable for fire and anti-smoking door</i>	
5 Sicurezza personale <i>Safety</i>	0	per uso normale <i>for normal use</i>	
	1	per uso con requisiti di sicurezza <i>for use with safety requirements</i>	
6 Resistenza alla corrosione <i>Corrosion resistance</i>	0	nessuna resistenza definita alla corrosione <i>no corrosion resistance</i>	
	1	ridotta resistenza alla corrosione <i>low corrosion resistance</i>	
	2	media resistenza alla corrosione <i>medium corrosion resistance</i>	
	3	alta resistenza alla corrosione <i>high corrosion resistance</i>	
	4	resistenza molto elevata alla corrosione <i>very high corrosion resistance</i>	
	5	resistenza estremamente elevata alla corrosione <i>extreme corrosion resistance</i>	
7 Sicurezza contro lo scasso <i>Security</i>	0	nessuna resistenza contro eventuale scasso <i>no resistance against possible forced entry</i>	
	1	ridotta resistenza allo scasso <i>low resistance against possible forced entry</i>	
	2	media resistenza allo scasso <i>medium resistance against possible forced entry</i>	
	3	alta resistenza allo scasso <i>high resistance against possible forced entry</i>	
	4	resistenza molto elevata allo scasso <i>very high resistance against possible forced entry</i>	
8 Tipo di azionamento <i>Type of operation</i>	A	con molla <i>with spring</i>	
	B	con precarico a molla <i>with spring preload</i>	
	C	senza molla <i>without spring</i>	

Finiture Finishes	Grado Grade
---------------------	---------------

Brunito/Burnished	1
Orsatop/Matt brass, Anticato/Antique, Cromoton/Satin black chrome, Nikelnero/Nickel black, Bronzop/Matt bronze, Bronzo scuro/Dark bronze	2
Ottone naturale antico/Antique natural brass, Fumè, Ramematt/Matt copper	3
Acciaio inox 304 lucido/Polished 304 stainless steel, Acciaio inox 304 satinato/Satin 304 stainless steel, Oro lucido/Polished brass, Orsatop/Satin brass, Oransat/Antique gold/satin brass, Patiné, Nickel, Nikmatt, Niksatan/Antique satin nickel, Bronzsat, Neropaco/Matt black, Tortora/Grey, Biancopaco/Matt white, Rame/Copper, Light black	4
Acciaio inox 316 lucido/Polished 316 stainless steel, Acciaio inox 316 satinato/Satin 316 stainless steel, Oro lucido-PVD/Polished brass-PVD, Orsatop-PVD/Satin brass-PVD, Cromo / Polished chrome, Cromo PVD/Polished chrome-PVD, Cromosat/Satin chrome, Cromosat-PVD/Satin chrome-PVD	5

Certificazione e Qualità | *Quality certifications*

ASSA ABLOY / Valli&Valli ha ottenuto le certificazioni | *has obtained the certifications:*

ACCREDIA
MEMBER OF THE ACCREDITED SOCIETY OF ITALY

MEMBER OF THE ACCORDS OF MUTUAL RECOGNITION EA, IAF AND ILAC
MEMBER OF THE ACCORDS OF MUTUAL RECOGNITION EA, IAF AND ILAC

ACCREDIA
MEMBER OF THE ACCREDITED SOCIETY OF ITALY

MEMBER OF THE ACCORDS OF MUTUAL RECOGNITION EA, IAF AND ILAC
MEMBER OF THE ACCORDS OF MUTUAL RECOGNITION EA, IAF AND ILAC

ACCREDIA
MEMBER OF THE ACCREDITED SOCIETY OF ITALY

MEMBER OF THE ACCORDS OF MUTUAL RECOGNITION EA, IAF AND ILAC
MEMBER OF THE ACCORDS OF MUTUAL RECOGNITION EA, IAF AND ILAC

C

Certifi
Certif

Meccani
ξ

CONFOI

Il pr



ICIM
Certificazione di Prodotto
Product Certification

Certificato N.
Certificate No. **ICIM-MNL-0000**

ALL'AZIENDA / TO THE FIRM
ASSA ABLOY ITALIA
Via Bovaresa, 13
10017 San Giovanni in Persiceto (E)
UNITÀ OPERATIVE / OPERATIVES UNIT
Valli&Valli Business Unit
Via Concordia 16 - 20838 Renate (M)
PER I SEGUENTI PRODOTTI / FOR THE FOLLOWING
MANIGLIE E POMOLI
LEVER HANDLES AND KNOB FURNITURE
CON DENOMINAZIONE COMMERCIALE / WITH TRADE NAME
Brand: Valli & Valli

Modelli: Vedi allegato
Models: See annex
Meccanismo molla: "New Spring CL4"
Spring type:
Material: Ottone
Materials: Brass
Finitura: Vedi tabella in allegato
Finish: See annex table

CONFORMEMENTE ALLA NORMA ED AL DOCUMENTO NORMA
IN COMPLIANCE WITH THE STANDARD AND WITH ICIM NORMATIV

EN 1906:2012 - ICIM 0414CS

CON CLASSIFICAZIONE / WITH CLASSIFICATION

4	7	-	0	0	*	0	B
---	---	---	---	---	---	---	---

* Corrosione: vedi tabella allegata
* Corrosion: see annex table

ICIM S.p.A.

PRIMA EMISSIONE
FIRST ISSUE
14/02/2017

EMISSIONE CORRENTE
CURRENT ISSUE
14/02/2020

ICIM S.p.A. - Piazzali Don Enrico Mapelli, 75 - 20090 Sesto San Giovanni (MI)

Prodotto
ation

01-01

S.p.A.

DO) - IT

IB) - IT

PRODUCTS

IRE

E NAME/S

TIVO ICIM
E DOCUMENT

TA DI SCADENZA
EXPIRING DATE

3/02/2023

1/3

Sistema
di Gestione Ambientale
ai sensi della Norma
UNI EN ISO 14001:2015

*Environmental
Management according to
UNI EN ISO 14001:2015*

Norma Europea
EN 1906:2012

*European Norm
EN 1906:2012*

Sistema
di Gestione Qualità
ai sensi della Norma
UNI EN ISO 9001:2015

*Quality Management
according to
UNI EN ISO 9001:2015*

CARBON
TRUST

Il sito produttivo di
Valli&Valli di Renate,
è stato certificato da
Carbon Trust come
sito a impatto zero

*Valli&Valli's primary
factory site, in Renate
(Italy), has achieved
verification from the
Carbon Trust that it
provides a zero waste
to landfill operation*

ASSA ABLOY Italia S.p.A.

Sede di Milano / Milan Unit
Via Concordia, 16
20838 Renate (MB) - Italy
www.assaabloy.it - www.vallievalli.com

Ufficio Commerciale Italia

Italian Business Office
Tel. +39 0362 982271
Fax +39 0362 982235
valli.italia@vallievalli.com

Ufficio Commerciale Export

Export Business Office
Tel. +39 0362 982260
Fax +39 0362 982214
valli.export@vallievalli.com

VALLI&VALLI USA INC

22 WEST 21ST. STREET 6TH. FLOOR
NEW YORK NY 10010
Tel. +1 212 326 8811
Fax +1 212 326 8816
TOLL FREE: 877 326 2565
TOLL FREE: 800 423 7161
sales@vallivalli-us.com

Experience

a safer

and more

open world

 **Valli&Valli**

ASSA ABLOY

Assa Abloy Italia S.p.A.

Sede di Milano

Milan Unit

Via Concordia 16

20838 Renate MB Italy

www.assaabloy.it

www.vallievalli.com

