

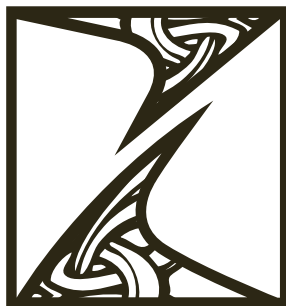

ZERMAT[®]
MADE IN ITALY





Zermat fornisce una linea completa di maniglioni e maniglie per porte e finestre, complete di accessori, progettati e realizzati esclusivamente in Italia.

La ricchezza del design e la qualità della lavorazione artigianale rispecchia l'evoluzione di una cultura artistica, rinforzando e confermando la garanzia del marchio "Made in Italy".

Ogni singolo pezzo, in ottone fuso e lavorato a mano, è unico e irripetibile come l'arte da cui prende ispirazione. Gli stili e i disegni sono classici, senza tempo, reminiscenti di un'epoca passata, ma sempre con un occhio al futuro.



Zermat provides a complete line of door handles, pull handles and window handles, including accessories and hardware, exclusively designed and manufactured in Italy.

The richness of the design and the quality of the hand crafted workmanship reflect the evolution of an artistic culture, reinforcing and confirming the guarantee of "Made in Italy".

Each individual piece, die-casted brass and hand processed, is as unique and unrepeatable as the art it takes inspiration from. The styles and designs are classic, timeless, reminiscent of an era past, but always with an eye to the future.



Finishes • Finiture



BY • Yester Bronze



GR • Scratched
Bronze



BV • Antique
Bronze



LV • Polished
Brass



CS • Satin
Chrome



PE • Pewter



FA • Antique
Iron



CL • Polished
Chrome



OV • Antique
Gold



PA • Patiné



CO • Antique
Copper



PV • PVD



NM • Nickel
Matt



NS • Satin
Nickel



AG • Antique
Silver



GP • Gold 24k

index • indice

MANIGLIONI - PULL HANDLES

Acropoli	pag. 12
Aosta	pag. 27
Arezzo	pag. 40
Bergamo	pag. 37
Brixia	pag. 46
Caserta	pag. 19
Colosseo	pag. 08
Como	pag. 43
Ducale	pag. 23
Ercolano	pag. 13
Ferrara	pag. 36
Firenze	pag. 16
Garda	pag. 33
Genova	pag. 34
Impero	pag. 28
Liberty	pag. 47
Lido	pag. 41
Livorno	pag. 17
Luxor	pag. 47
Mantova	pag. 36
Milano	pag. 26
Monza	pag. 43
Murano	pag. 23
Napoli	pag. 18
Paestum	pag. 09
Palio	pag. 42
Pantheon	pag. 10
Pistoia	pag. 39
Pompei	pag. 14
Positano	pag. 15
Rimini	pag. 46
Roma	pag. 11
Salò	pag. 41
Sanremo	pag. 40
Saturnia	pag. 35
Siena	pag. 38
Sirmione	pag. 21
Sorrento	pag. 24
Trieste	pag. 32
Udine	pag. 31
Venezia	pag. 22
Verona	pag. 20
Vietri	pag. 25
Vinci	pag. 42
Volterra	pag. 17

MANIGLIE - DOOR HANDLES

Brixia	pag. 72-73
Capri	pag. 52-53
Impero	pag. 76-77
Ischia	pag. 78-79
Liberty	pag. 68-69
Lucca	pag. 65
Luxor	pag. 66-67
Milano	pag. 64
Napoli	pag. 58-59
Ortisei	pag. 50-51
Pistoia	pag. 70-71
Pompei	pag. 56-57
Rimini	pag. 74-75
Roma	pag. 62-63
Taormina	pag. 60-61
Verona	pag. 54-55
Placche - Plates	pag. 80
Rosette - Roses	pag. 81-82-83
Entry Sets	pag. 44

index • indice



Colosseo Paestum
pag. 8 pag. 9



Pantheon Roma
pag. 10 pag. 11



Acropoli Ercolano
pag. 12 pag. 13



Pompei Positano
pag. 14 pag. 15



Firenze Livorno
pag. 16 pag. 17



Napoli Caserta
pag. 18 pag. 19



Verona Sirmione
pag. 20 pag. 21



Venezia Murano
pag. 22 pag. 23



Sorrento Vietri
pag. 24 pag. 25



Milano Aosta
pag. 26 pag. 27



Impero
pag. 28

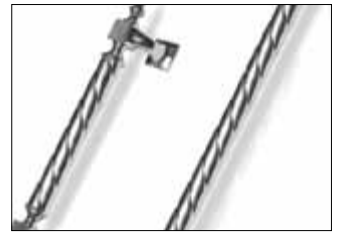

Udine
pag. 31



Trieste Garda
pag. 32 pag. 33



Genova Saturnia
pag. 34 pag. 35



Ferrara Bergamo
Mantova pag. 37



Siena Pistoia
pag. 38 pag. 39



**Sanremo - Arezzo -
Salò - Lido**
pag. 40



**Palio - Vinci -
Como - Monza**
pag. 42



Entry Sets
pag. 44



**Rimini - Brixia -
Luxor - Liberty**
pag. 46

index • indice



Ortisei
pag. 50



Capri
pag. 52



Verona
pag. 54



Pompei
pag. 56



Napoli
pag. 58



Taormina
pag. 60



Roma
pag. 62



Milano **Lucca**
pag. 64 pag. 65



Luxor
pag. 66



Liberty
pag. 68



Pistoia
pag. 70



Brixia
pag. 72



Rimini
pag. 74



Impero
pag. 76



Ischia
pag. 78



Plates and Roses
pag. 80

This catalog is the most recent creation Designed by Zermat for the New Collection. All the molds are created with the latest technology.

Every product is constantly and strategically Improved from its previous version. Not only to confer the best visual impact, but to improve its structural construction, its resistance and its durability.



pull handles



colosseo

MT160.GP





Paestum è un'antica città della Magna Grecia, chiamata dai fondatori Poseidonia in onore di Poseidone, devotissima a Era e Atena.

L'estensione del suo abitato è ancora oggi ben riconoscibile, racchiuso dalle sue mura greche, così come modificate in epoca lucana e poi romana. In passato era nota anche come Pesto.

È localizzata nella regione Campania, in provincia di Salerno.

I maniglioni Colosseo e Paestum raccontano l'influenza di questi tre popoli e i loro stili.

Paestum was a major ancient coastal greek city of the Tyrrhenian sea in Magna Grecia.

After its foundation by greek colonists under the name of Poseidonia it was eventually conquered by the Lucanians and later the Romans. The Lucanians renamed it Paistos and the Romans gave the city its current name.

The ruins of Paestum are notable for their well preserved ancient Greek temples. Today the remains of the city are found in the modern town of the same name, in the Province of Salerno, Campania, Italy.

the pull handles Colosseo and Paestum embody the influence and styles of these ancient cultures.



pantheon

MT255.AG



814 mm



646 mm





Roma è la capitale della Repubblica Italiana, e capoluogo della regione Lazio.

Per antonomasia è definita La Capitale del Mondo, l'Urbe e la **Città Eterna**.

Fondata secondo la tradizione il 21 aprile 753 a.C. (sebbene scavi recenti nel Lapis niger farebbero risalire la fondazione a 2 secoli prima), nel corso dei suoi tre millenni di storia è stata la prima grande metropoli dell'umanità e il cuore di una delle più importanti civiltà antiche.

Roma influenzò la società, la cultura, la lingua, la letteratura, l'arte, l'architettura, la filosofia, la religione, il diritto e i costumi dei secoli successivi.

Rome (Italian: Roma, Latin: Rōma) is the capital of Italy and of the region of Lazio.

Rome's history spans more than two and a half thousand years. While Roman mythology dates the founding of Rome at only around 753 BC, the site had been inhabited for much longer, making it one of the oldest continuously occupied sites on record.

It is still referred to as "Roma Aeterna" (**The Eternal City**) and "Roma Caput Mundi" (**Capital of the World**), two essential notions in ancient Roman culture.

Only the pull handles Roma and Acropoli can summarize the timeless esthetic of the eternal city.



acropoli

MT155.GP





MT157.AG
ercolano



pompei
MT156.GP



583 mm

733 mm





Pompei è un comune italiano della città metropolitana di Napoli in Campania.

Nel 79 d.C. Pompei, assieme ad Ercolano e ad alcune ville nelle vicinanze, fu sommersa da una pioggia di cenere e lapilli proveniente dal vulcano **Vesuvio** che cadde ininterrotta fino a formare uno strato misurato dai 4 ai 6 metri.

Nel 1997 l'**UNESCO** ha dichiarato Pompei **Patrimonio Mondiale dell'Umanità** considerando che gli straordinari reperti delle città di Pompei, Ercolano e delle città limitrofe sepolte dall'eruzione costituiscono la testimonianza unica di una struttura sociale conservata pressoché intatta per due millenni.

The city of **Pompeii** was an ancient Roman city near modern Naples in the Italian region of Campania.

Pompeii, along with the ancient city of Herculaneum (Ercolano) as well as many villas in the surrounding area, were mostly destroyed and buried under 4 to 6 m (13 to 20 ft) of volcanic ash and pumice in the eruption of Mount Vesuvius in 79 AD.

Pompeii has been a tourist destination for over 250 years. Today it has **UNESCO World Heritage Site** status.



firenze
MT183.GR



541 mm

692 mm





volterra



livorno



MT185.PE MT184.CO+FA
livorno volterra

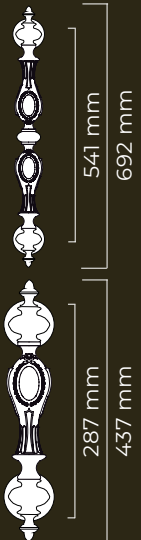

napoli
MT169.PA



540 mm

690 mm





Napoli è un comune italiano, terzo in **Italia** per popolazione dopo Roma e Milano, capoluogo della regione **Campania**, centro di una delle aree urbane più popolate e densamente abitate dell'Unione europea.

Napoli è una delle più antiche città perennemente inabitate della storia.

La città venne rifondata con il nome Neápolis nel sesto secolo AC e diventò un cardine della **Magna Grecia** unendo la cultura Greca con la società romana fino a divenire un centro culturale della **repubblica Romana**.

Includendo più di 27 secoli di storia, il centro storico di Napoli, il **più vasto d'Europa**, è stato riconosciuto nel 1955 dall'**UNESCO** come **patrimonio mondiale dell'umanità**.

Naples is the capital of the Italian region of Campania and the third-largest municipality in Italy, after Rome and Milan.

Naples is one of the oldest continually inhabited cities in the world.

The city was refounded as Neápolis in the sixth century BC and became a lynchpin of **Magna Graecia**, playing a key role in the merging of Greek culture into Roman society and eventually becoming a **cultural center of the Roman Republic**.

Naples' historic city centre is the **largest in Europe**, embracing 27 centuries of history, listed by **UNESCO** as a **World Heritage Site**.



verona

MT188.BY





Verona è un comune italiano nella Regione del Veneto.

Una delle mete preferite dai turisti da tutto il mondo, Verona è un chiaro esempio di città che si è sviluppata progressivamente e ininterrottamente durante duemila anni, integrando elementi artistici di altissima qualità dei diversi periodi che si sono succeduti; rappresenta inoltre in modo eccezionale il concetto di città fortificata in più tappe determinanti della storia europea. Per questo la città è stata dichiarata patrimonio dell'umanità dall'UNESCO.

Tre delle opere di William Shakespeare sono ambientate nella città di Verona: "Romeo e Giulietta", "La bisbetica domata" e "I due gentiluomini di Verona".

Verona is a city straddling the Adige river in the Veneto region.

It is one of the main tourist destinations of northern Italy, owing to its artistic, historical and cultural heritage. The Arena, the ancient amphitheatre built by the Romans, is the focal point for cultural events in Italy like Operas, theatrical performances and concerts.

Three of William Shakespeare's plays are set in Verona: "Romeo and Juliet", "The Taming of the Shrew", and "The Two Gentlemen of Verona".

The city has been awarded World Heritage Site status by UNESCO.



venezia

MT127.BY



532 mm

680 mm



ducale



murano



MT126.GP

MT116.FA

murano ducale

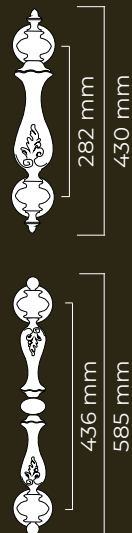

sorrento

MT164.PA



518 mm

660 mm





Sorrento (Surrient in napoletano) è un comune della città metropolitana di Napoli.. Meta turistica per eccellenza, da sempre per le sue bellezze naturali ed artistiche e le sue tradizioni, Sorrento è il maggiore centro di tutta la Penisola Sorrentina.

Vietri sul Mare (Vietre in campano) è un comune italiano nella provincia di Salerno in Campania. Si trova di fronte all'entrata settentrionale della Costiera amalfitana.

L'UNESCO ha dichiarato dal 1997 Vietri sul Mare (insieme agli altri paesi della costiera amalfitana) Patrimonio dell'umanità.

Sorrento is a town overlooking the Bay of Naples. Always been a tourist destination par excellence for its natural and artistic beauty and its traditions, Sorrento is the largest center of the Sorrento Peninsula.

Vietri sul Mare ("Vietri on the Sea") is a town in the province of Salerno, in the Campania region of southern Italy. It is a popular tourist destination because it is a convenient place to start the amazing Amalfi Coast drive.

UNESCO declared in 1997 Vietri sul Mare (along with the other towns of the Amalfi Coast) World Heritage.



milano
MT165.PA

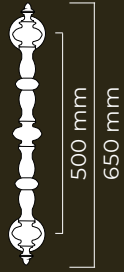



Milano è una città italiana capoluogo della regione **Lombardia**, terza area metropolitana più popolata d'Europa dietro Londra e Parigi.

Fondata dagli Insubri all'inizio del VI secolo a.C., fu conquistata dai Romani nel 222 a.C. e fu chiamata **Mediolanum**; fino a divenire una delle sedi imperiali dell'**Impero romano d'Occidente**.

Milano è il maggiore mercato finanziario italiano; è inoltre una delle **capitali mondiali della moda** e del disegno industriale. Milano si attesta, come 12^a città più visitata del mondo, 5^o d'Europa e 1^o d'Italia.

Milan (Italian: **Milano**), is a city capital of the Italian region of **Lombardy**, the third most populous metropolitan area in Europe after London and Paris.

Milan was founded by Celts known as Insubres. The Romans later conquered the city, which they knew as **Mediolanum**, and which eventually became the capital of the **Western Roman Empire**.

Milan is the largest Italian financial market; It is also one of the world **capital of fashion** and industrial design. Milan stands as the 12th most visited city in the world, 5th in Europe and 1st in Italy.

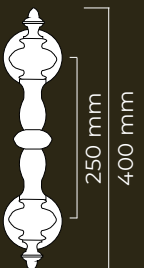



MT106Z.LV



MT108.AG

MT106



MT107



MT108



MT109

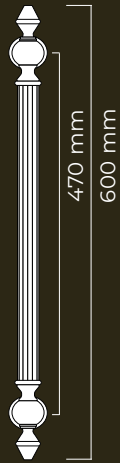

MT110

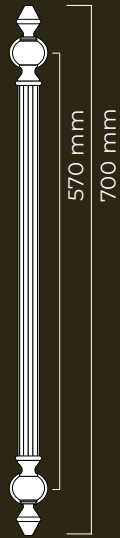

MT900

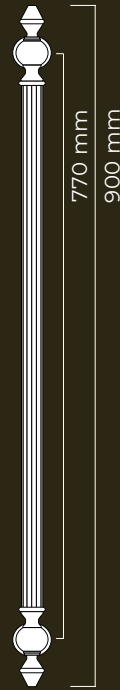

MT999

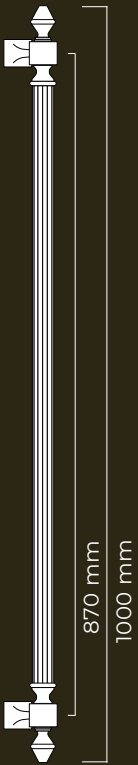
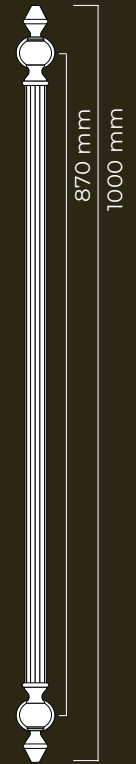

MT999z

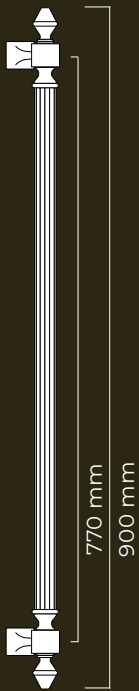

MT900z



MT110z

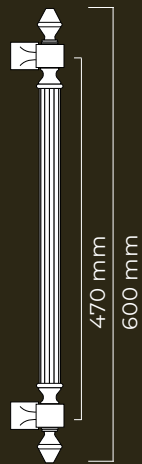

MT109z



MT108z



MT107z

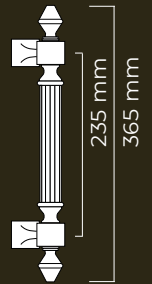

MT106z

diameter mm 30

MT1600



MT1601



MT1602



MT1603

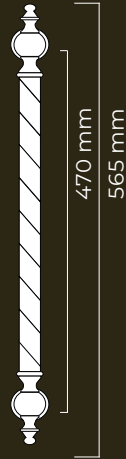

MT1604

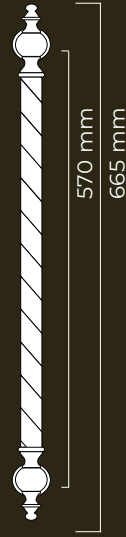

MT1605

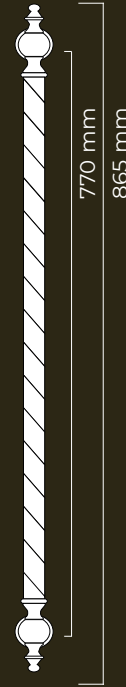

MT1609

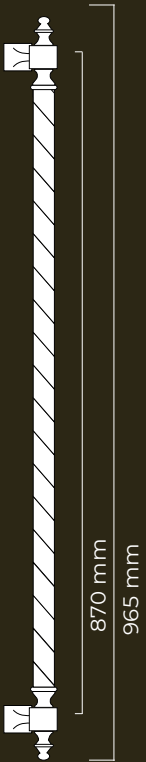
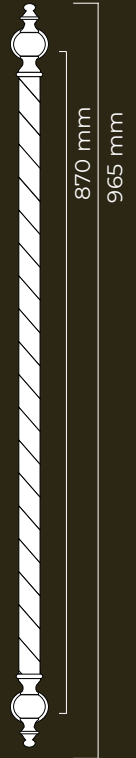

MT1609z

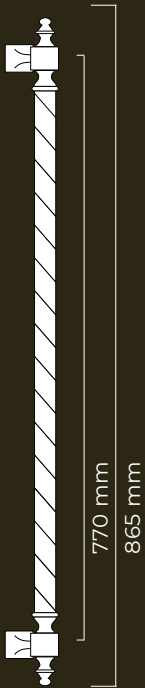

MT1605z

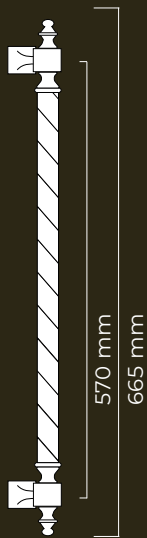

MT1604z

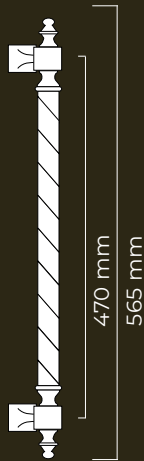

MT1603z

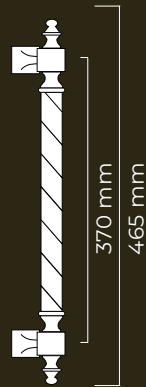

MT1602z



MT1601z

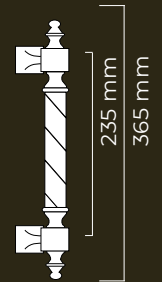

MT1600z



MT1601Z.CL



MT1600.BY





diameter mm 30

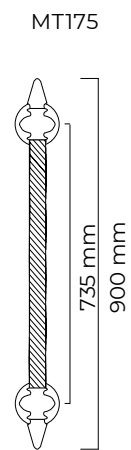
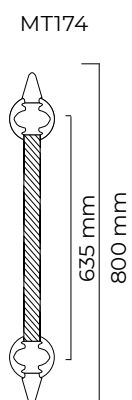
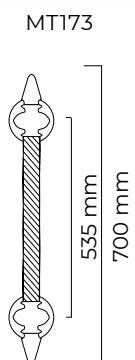
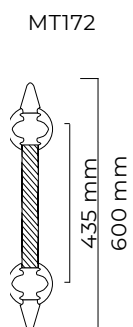
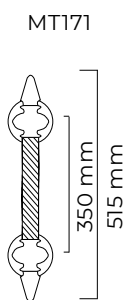



MT1630Z.PA

MT1630.FA

garda z

garda

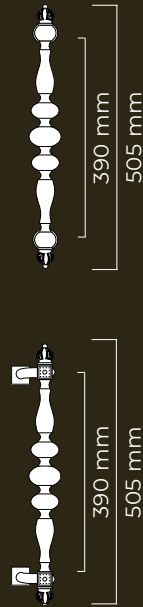

genova z

genova

MT1633Z.CO

MT1633.BY



362 mm

470 mm

362 mm

470 mm





MT1631Z.OV MT1631.BY
saturnia z saturnia

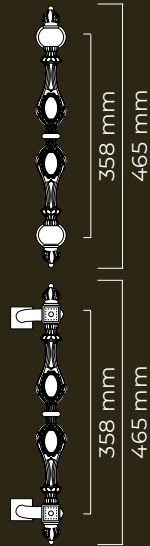

ferrara z
MTZ1620Z.AG

ferrara
MT1620.PE



365 mm

475 mm

365 mm

475 mm



mantova z mantova

MT1637Z.CL

MT1637.CL

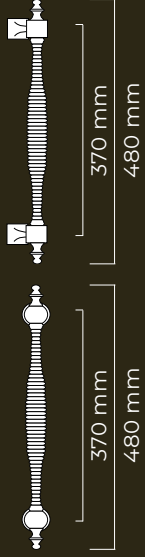



MT139Z.BY
MT139.FA
bergamo z bergamo

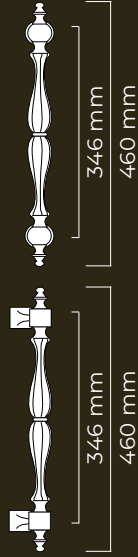

siena z
MT151Z.FA

siena
MT151.BY

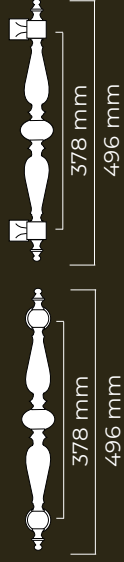



MT1629Z.BY

MT1629.PE

pistolia z

pistolia

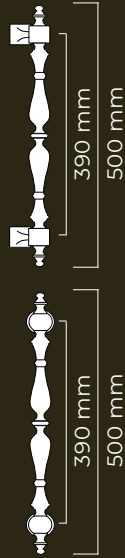



Sanremo



Arezzo

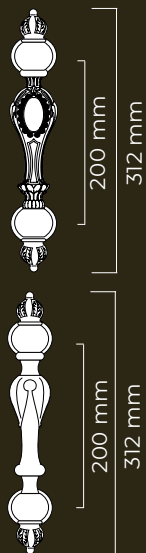

MADE IN ITALY

The complete ZERMAT production cycle takes place in Italy. Starting from the design, to the production to the final packaging; every single item, from start to finish, is entirely Italian made.

MADE IN ITALY

L'intera produzione di ZERMAT ha luogo in Italia. Partendo dai progetti di quelli che diverranno maniglioni o maniglie fino al packaging e le nostre scatole, ogni dettaglio è completamente realizzato in Italia.

Salò



Lido



MT316.FA

lido

MT1643.PA

salò



Customization

Zermat's products are available in a wide variety of finishes: golds, irons, bronzes, coppers and more.

Zermat offers many "standard finishes" plus many "special finishes", also available in combinations!

Personalizzazione

I prodotti zermat sono disponibili in molte finiture: diversi tipi di bronzo, ottone, oro, rame e altro ancora.

Zermat propone molte finiture standard e altre finiture speciali. Anche combinabili tra loro!

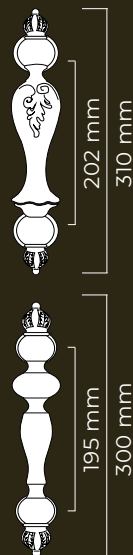

vinci
MT329.AG

paliolo
MT149.GP

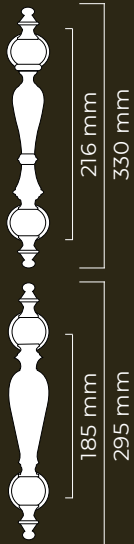

Excellence and Innovation

All the ZERMAT models are made utilizing the latest state of technologies, ensuring the highest possible quality of our products.

Eccellenza e Innovazione

Tutti i nuovi modelli Zermat sono realizzati utilizzando le più recenti tecnologie in modo da ottenere sempre la migliore qualità.

Monza



Como



MT145P.PA
monza

MT144P.GP
como



Evolution and Improvement

Several of Zermat's products have been strategically improved from their previous versions, not only to confer the best visual impact, but also to improve the structural construction, the resistance and the durability.

Evoluzione e Progresso

Tutti i prodotti Zermat sono costantemente aggiornati. Non solo per migliorarne l'aspetto, ma per incrementarne la struttura e rafforzarne la resistenza.

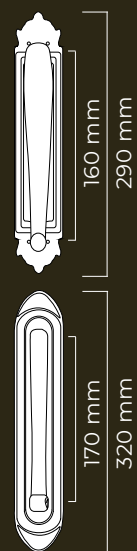

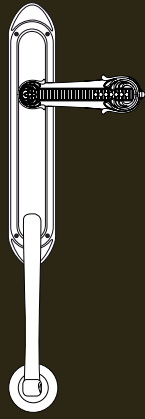

entry set ortisei

ES2907.Y.NS

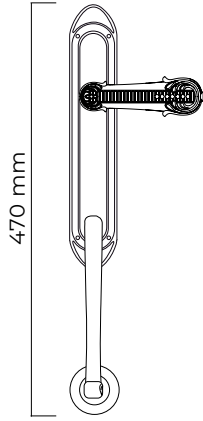

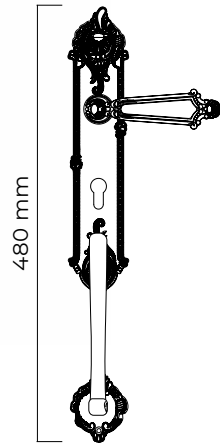

ES3220.Y.BY
entry set verona



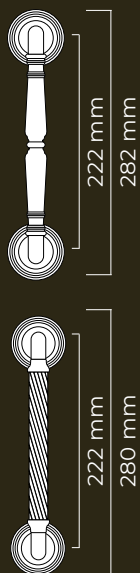

diameter mm 20



Excellence and Innovation

All the ZERMAT models are made utilizing the latest state of technologies, ensuring the highest possible quality of our products.

Eccellenza e Innovazione

Tutti i nuovi modelli Zermat sono realizzati utilizzando le più recenti tecnologie in modo da ottenere sempre la migliore qualità.



Luxor



Liberty

MT142.AG
luxor

MT150.FA
liberty



Evolution and Improvement

Several of Zermat's products have been strategically improved from their previous versions, not only to confer the best visual impact, but also to improve the structural construction, the resistance and the durability.

Evoluzione e Progresso

Tutti i prodotti Zermat sono costantemente aggiornati. Non solo per migliorarne l'aspetto, ma per incrementarne la struttura e rafforzarne la resistenza.

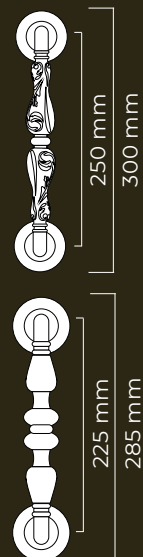



door handles



ortisei
MM2910.BY

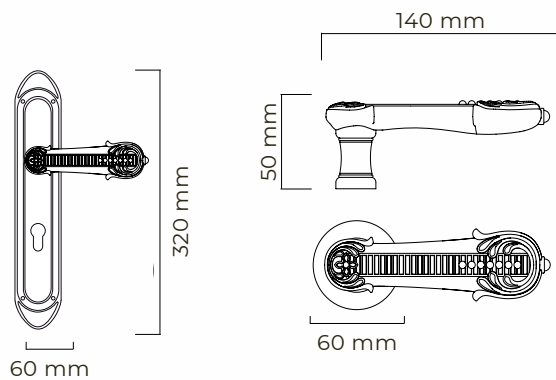
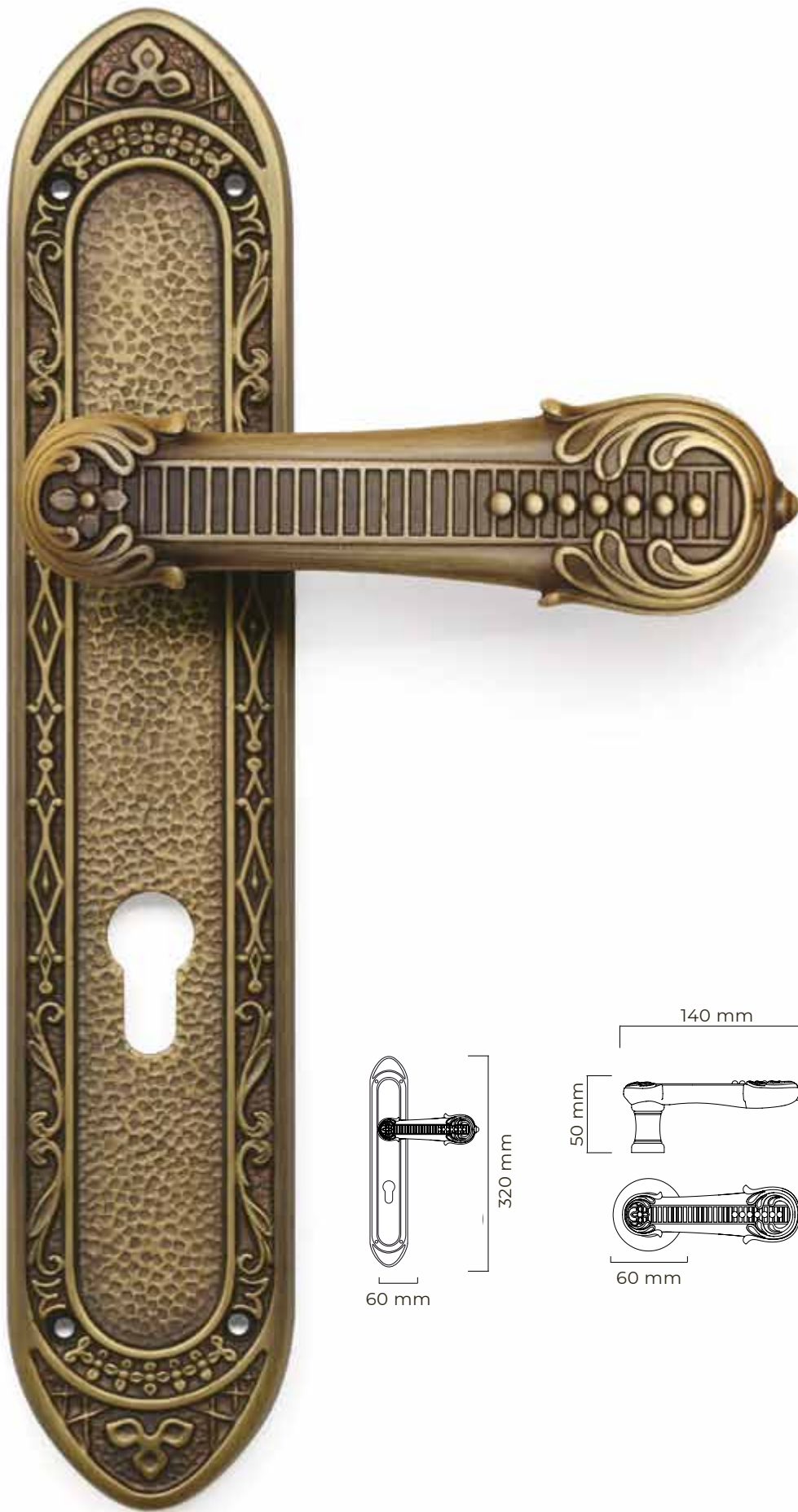



Ortisei (Urtijëi in ladino, St. Ulrich in tedesco) è un comune italiano della provincia autonoma di **Bolzano** in **Trentino-Alto Adige**.

Il paesaggio alpino che le fa da sfondo è quello delle famosissime **Dolomiti**. Queste ultime contribuiscono alla fama del luogo e della valle che risultano essere rinomati posti di villeggiatura di eccezionale bellezza.

Nel 2009 queste montagne hanno ricevuto la nomina a **patrimonio culturale dell'umanità** dall'**UNESCO**.

Urtijëi (German: St. Ulrich in Gröden; Italian: **Ortisei**) is a town in **South Tyrol** in northern **Italy**. It occupies the Val Gardena within the Dolomites, a mountain chain that is part of the **Alps**.

Currently, the town's economy is mostly based on winter skiing tourism, summer hiking tourism, and woodcarving.

In August 2009, the Dolomites were declared by **UNESCO** a **World Heritage Site**.

capri

MM2810.PA

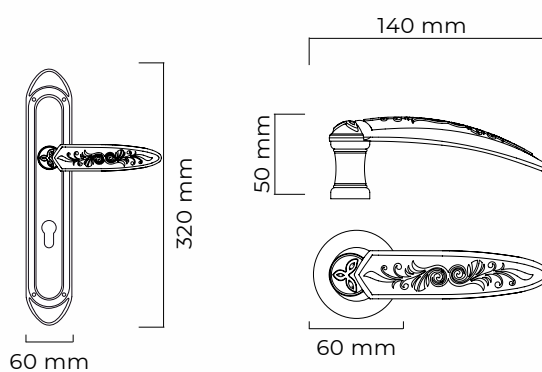



Capri è un'isola nel golfo di Napoli, situata di fronte alla penisola sorrentina, nonché una delle maggiori mete turistiche in **Italia**.

L'isola è caratterizzata da numerose grotte e cale che si alternano a ripide scogliere. Le grotte, nascoste sotto le scogliere, furono utilizzate in epoca romana come ninfei delle sontuose ville che vennero costruite qui durante l'Impero. La più famosa è senza dubbio la **Grotta Azzurra**, in cui magici effetti luminosi furono descritti da moltissimi scrittori e poeti.

Capri is an island located in the Tyrrhenian Sea off the Sorrentine Peninsula, on the south side of the Gulf of Naples in **Italy**.

The main town Capri that is located on the island shares the name. It has been a resort since the time of **the Roman Republic**.

The most visited attraction in Capri is the **Grotta Azzurra** (Blue Grotto), a special cave, discovered in the 19th century and been a phenomenon ever since. On one side of the grotto are the remains of ancient Roman rock, with a narrow cavern.

verona

MM3220.BY

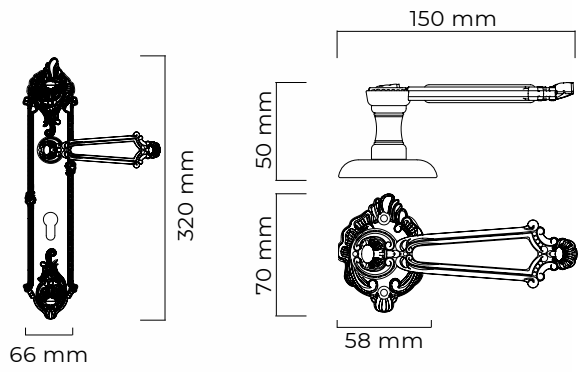



Verona è un chiaro esempio di città che si è sviluppata progressivamente e ininterrottamente durante duemila anni, integrando elementi artistici di altissima qualità dei diversi periodi che si sono succeduti; rappresenta in modo eccezionale il concetto di città fortificata in più tappe determinanti della storia europea. Per questo la città è stata dichiarata **patrimonio dell'umanità** dall'**UNESCO**.

Tre delle opere di **William Shakespeare** sono ambientate nella città di Verona: "**Romeo e Giulietta**", "La bisbetica domata" e "I due gentiluomini di Verona".

Verona is one of the main tourist destinations of northern **Italy**, owing to its artistic, historical and cultural heritage. **the Arena**, the ancient amphitheatre built by the Romans, is the focal point for cultural events in Italy like Operas, theatrical performances and concerts.

Three of **William Shakespeare's** plays are set in Verona: "**Romeo and Juliet**", "The Taming of the Shrew", and "The Two Gentlemen of Verona".

The city has been awarded **World Heritage Site** status by **UNESCO**.

pompei
MM2710.BY

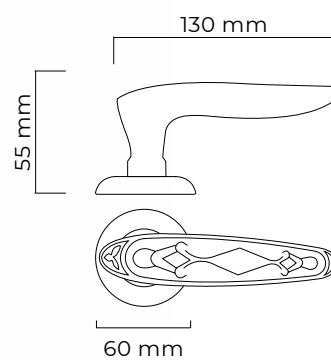
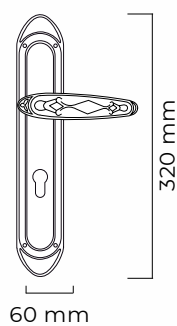



Pompei è un comune italiano della città metropolitana di Napoli in Campania.

Nel 79 d.C. **Pompei**, assieme ad **Ercolano** e ad alcune ville nelle vicinanze, fu sommersa da una pioggia di cenere e lapilli proveniente dal monte **Vesuvio** che cadde ininterrotta fino a formare uno strato misurato dai 4 ai 6 metri.

Nel 1997 l'**UNESCO** ha dichiarato Pompei **Patrimonio Mondiale dell'Umanità** considerando che gli straordinari reperti delle città di Pompei, Ercolano e delle città limitrofe sepolte dall'eruzione costituiscono la testimonianza unica di una struttura sociale conservata pressoché intatta per due millenni.

The city of **Pompeii** was an ancient Roman city near modern **Naples** in the Italian region of Campania.

Pompei, along with the ancient city of Herculaneum (**Ercolano**) as well as many villas in the surrounding area, were mostly destroyed and buried under 4 to 6 m (13 to 20 ft) of volcanic ash and pumice in the eruption of **Mount Vesuvius** in 79 AD.

Pompei has been a tourist destination for over 250 years. Today it has **UNESCO World Heritage Site** status.

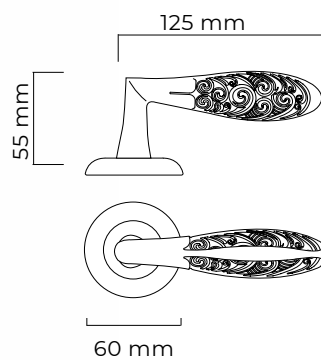
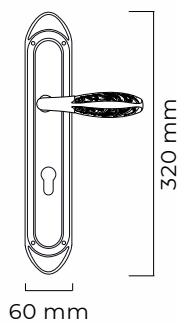



Napoli è terzo comune in **Italia** per popolazione dopo Roma e Milano, capoluogo della regione **Campania**.

Napoli è una delle più antiche città perennemente inabitate della storia.

La città venne rifondata con il nome Neápolis nel sesto secolo AC e diventò un cardine della **Magna Grecia** unendo la cultura Greca con la società romana fino a divenire un centro culturale della **repubblica Romana**.

Includendo più di 27 secoli di storia, il centro storico di Napoli, il **più vasto d'Europa**, è stato riconosciuto nel 1955 dall'**UNESCO** come **patrimonio mondiale dell'umanità**.

Naples (Italian: **Napoli**, Latin: Neapolis; Ancient Greek: Νεάπολις, meaning "new city") is the capital of the Italian region of Campania and the third-largest municipality in Italy, after Rome and Milan.

Naples is one of the oldest continually inhabited cities in the world.

The city was refounded as Neápolis in the sixth century BC and became a lynchpin of **Magna Graecia**, playing a key role in the merging of Greek culture into Roman society and eventually becoming a **cultural center of the Roman Republic**.

Naples' historic city centre is the **largest in Europe**, embracing 27 centuries of history, listed by **UNESCO** as a **World Heritage Site**.

taormina

MM2310.PE

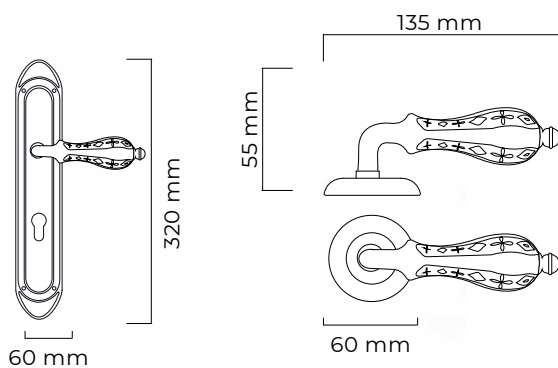



Taormina è uno dei centri turistici internazionali di maggiore rilievo della **Sicilia**, conosciuta per il suo paesaggio naturale, le bellezze marine e i suoi monumenti storici.

Il **teatro antico** è stato impiegato come struttura teatrale all'aperto per varie forme di spettacolo che spaziano dal teatro ai concerti, dalle cerimonie di premiazione del David di Donatello ai concerti sinfonici, dall'opera lirica al balletto. Dal 1983 è sede di Taormina Arte, e del **Taormina Film Fest**.

Taormina (Greek: Ταυρομένιον Tauromenion, Latin: Tauromenium, Arabic: إن م ر ب ط) is a small town on the east coast of the island of **Sicily, Italy**. Taormina has been a tourist destination since the 19th century.

The most remarkable monument remaining at Taormina is the **Ancient theatre**, which is one of the most celebrated ruins in Sicily

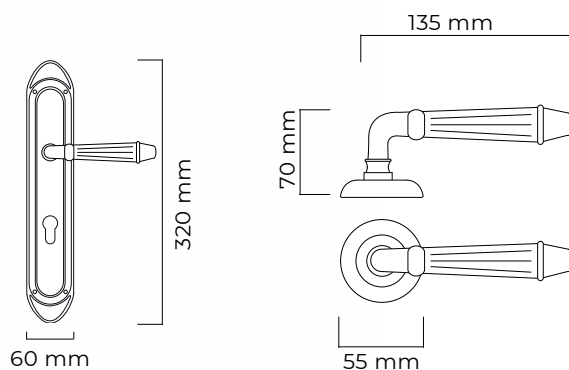



Roma è la capitale della Repubblica Italiana, e capoluogo della regione Lazio.

Per antonomasia è definita La Capitale del Mondo, l'Urbe e la **Città Eterna**.

Fondata secondo la tradizione il 21 aprile 753 a.C. (sebbene scavi recenti nel Lapis niger farebbero risalire la fondazione a 2 secoli prima), nel corso dei suoi tre millenni di storia è stata la prima grande metropoli dell'umanità e il cuore di una delle più importanti civiltà antiche.

Rome (Italian: Roma, Latin: Rōma) is the capital of Italy and of the region of Lazio.

Rome's history spans more than two and a half thousand years. While Roman mythology dates the founding of Rome at only around 753 BC, the site had been inhabited for much longer, making it one of the oldest continuously occupied sites on record.

It is still referred to as "Roma Aeterna" (**The Eternal City**) and "Roma Caput Mundi" (**Capital of the World**), two essential notions in ancient Roman culture.

milano
MM2509.BY

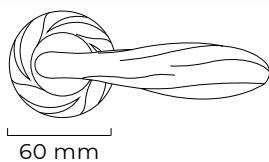

60 mm

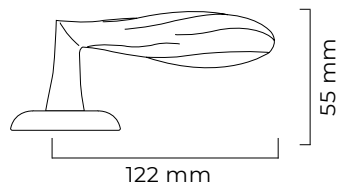

122 mm

55 mm



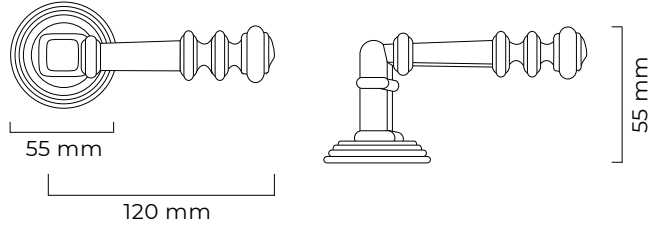

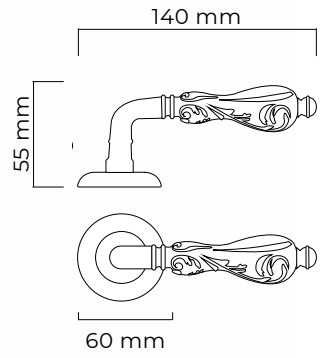
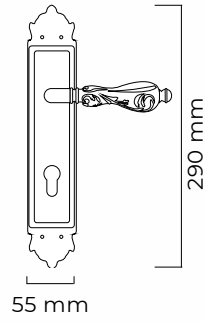



MM2104.OV
luxor

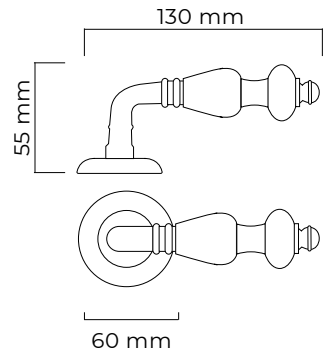
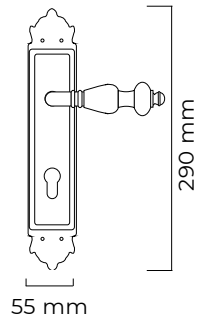



MM2204.FA
liberty



pistola

MM9330.BY

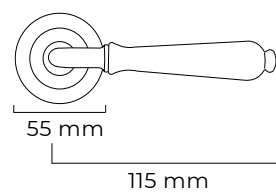
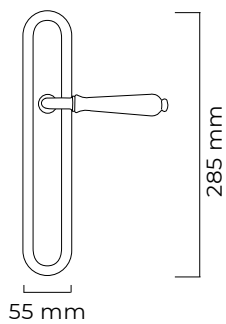



La città di **Pistoia** è particolarmente ricca di pregevoli monumenti romanici e rinascimentali e soprattutto può vantare una delle più suggestive piazze d'Italia: **piazza del Duomo**, centro geometrico di Pistoia, monumentale fulcro sia del potere civile che ecclesiastico.

*«[...] T'amo, città di crucci, aspra Pistoia,
pel sangue de' tuoi Bianchi e de' tuoi Neri,
che rosseggiar ne' tuoi palagi fieri
veggo, uom di parte, con antica gioia.»*

(Gabriele D'Annunzio)

Pistoia is a city in the **Tuscany** region of Italy.

After the city became a Roman colony in the 6th century BC, it was a place for activities or trades.

The city is filled of nice monuments from both its renaissance and the Roman colonization.

Dante mentioned the town in his **Divina Commedia**.

Michelangelo called the people of Pistoia the "enemies of heaven".

brixia
MM9730.FA

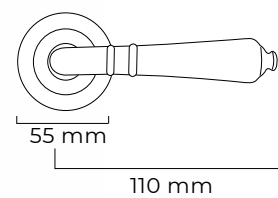
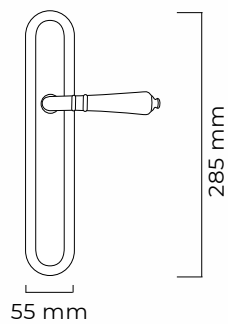

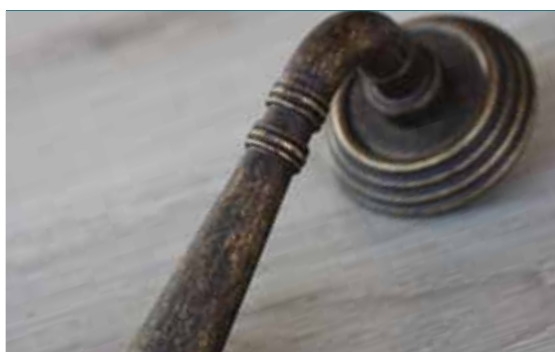

Brescia (**Brixia** in latino) è tra i principali centri economico-produttivi del Paese.

Antica città (le origini risalgono a oltre 3200 anni fa) conosciuta per la celebre corsa d'auto d'epoca **Mille Miglia** e per la produzione dei vini **Franciacorta**, possiede un cospicuo patrimonio artistico e architettonico: i suoi monumenti d'epoca romana e longobarda sono stati dichiarati dall'UNESCO **Patrimonio mondiale dell'umanità**.

La città è soprannominata "**Leonessa d'Italia**" per i dieci giorni di resistenza agli austriaci durante il Risorgimento Italiano.

Brescia (in antiquity **Brixia**) is a city situated at the foot of the Alps, a few kilometres from the lakes Garda and Iseo.

Founded over 3,200 years ago, Brescia has been an important centre since pre-Roman times. Its old town contains the **best-preserved Roman public buildings in northern Italy** and numerous monuments.

The monumental archaeological area have become a **UNESCO World Heritage Site**.

rimini

MM9630.BY

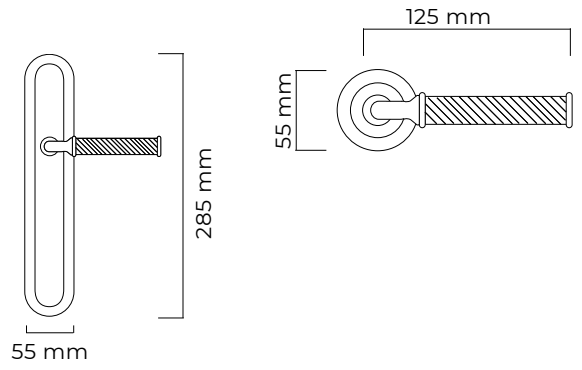



Rimini è il principale, nonché più popoloso, centro della Riviera romagnola.

Località di soggiorno estivo di fama internazionale, fu sulla spiaggia di Rimini che nel 1843 venne inaugurato **il primo stabilimento balneare in Italia**.

Fondata dai Romani nel 268 a.C., è stata un fondamentale nodo di comunicazione fra il nord e il sud della penisola e sul suo suolo gli imperatori romani eressero monumenti dei quali restano tracce importanti.

Rimini is the main and most populous center of the Riviera Romagnola.

An internationally renowned summer resort, it was on the beach of Rimini that in 1843 the **beach establishment** in Italy was inaugurated.

Founded by the Romans in 268 BC, it was a fundamental communication node between the north and south of the peninsula and on its soil the Roman emperors erected monuments of which important traces are still living.

impero
MM9130.FA

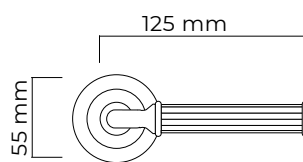
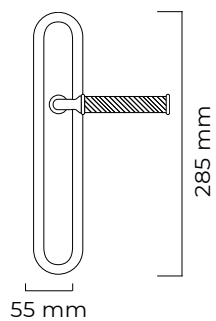



ischia

MM760F.BV

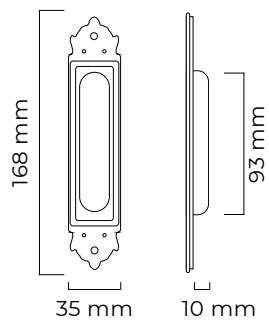



MM760
ischia

plates • placche



00 luxor • 290x55mm



10 pompeii • 330x60mm



30 rimini • 285x55mm



20 verona • 330x60mm



R4 · 90mm



R1 · 80mm



R8 · 90mm





15 • RO55
Pistoia WC + nott



06 • RZ55
Rimini WC + nott



04 • RR60
Napoli WC + nott



15 • RO55
Pistoia yale hole



06 • RZ55
Rimini yale hole



04 • RR60
Napoli yale hole



15 • RO55
Pistoia key hole



06 • RZ55
Rimini key hole



04 • RR60
Napoli key hole



07 · RF60
Pompei WC + nott



12 · RV65
Verona WC + nott



09 · RM60
Milano WC + nott



07 · RF60
Pompei yale hole



12 · RV65
Verona yale hole



09 · RM60
Milano yale hole



07 · RF60
Pompei key hole



12 · RV65
Verona key hole



09 · RM60
Milano key hole





Frascio s.r.l.

Via Nazionale, 6
25074 Lavenone, Brescia

ITALY

www.zermat.com

www.frascio.it



Frascio s.r.l.

Via Nazionale, 6
25074 Lavenone, Brescia

ITALY

www.zermat.com

www.frascio.it