

GENERAL CATALOGUE



PASINI

ITALIAN LUXURY HANDLES



MADE IN ITALY SINCE 1967



PASINI
ITALIAN LUXURY HANDLES

Da oltre 50 anni la nostra famiglia lavora nel settore dell'ottone, creando con amore e passione maniglie e accessori distribuiti in tutto il mondo. Siamo felici oggi di presentare il nostro nuovo catalogo generale, frutto del lavoro e della visione che in tutti questi anni hanno portato a far conoscere il brand Pasini come un riferimento di qualità, creatività e innovazione. L'unicità dei nostri prodotti, sta nella cura artigianale con la quale vengono creati, nella tradizione e nelle attitudini positive del vero Made in Italy. La collaborazione con istituti di ricerca, università di architettura e designer internazionali, ci permette invece di essere innovativi nella ricerca di materiali e nei brevetti di nuove soluzioni tecnologiche, che possano certificare l'eccellenza dei nostri prodotti. Un grazie particolare pertanto, a tutti i nostri collaboratori che credono e sostengono il nostro progetto ed a tutte le persone che si apprestano a sfogliare questo catalogo. Oggi ci presentiamo con una gamma di maniglie, maniglioni e accessori tra le più complete a livello internazionale, per esprimere al meglio il lavoro che da due generazioni siamo orgogliosi di offrirvi.

made in Italy

For over 50 years our family has been working in the brass sector, creating with love and passion handles and accessories distributed all over the world. We are proud today to present you our new general catalogue, the result of a work and vision that in all these years has led to make the Pasini brand known as a reference for quality, creativity and innovation. The uniqueness of our products, is in the artisanal care with which they are created, in the tradition and positive attitudes of the true Made in Italy. Collaboration with research institutes, universities of international architecture and designers, allows us to be innovative in materials research and patents new technological solutions, that can certify the excellence of our products. A special thanks therefore to all our collaborators who believe and support our project and to all the people that will browse this catalog. Today we introduce ourselves with a range of handles, pull handles and accessories among the most complete at international level, to best express the work that for two generations we are proud to offer you.



PASINI
ITALIAN LUXURY HANDLES

Il Made in Italy è per noi autentico riflesso della cultura italiana, delle tradizioni e delle attitudini positive che ci accompagnano nella vita di tutti i giorni. È molto più, quindi, di una semplice certificazione di qualità. Ciò è evidente nel rapporto umano e di amicizia che instauriamo con i nostri Clienti e nella nostra continua ricerca del bello, anche nelle piccole cose. Le nostre maniglie personalizzate sono da anni portavoce del design italiano, grazie alle loro eccellenti particolarità:

- materie prime utilizzate di altissima qualità;
- dettagli realizzati con cura e attenzione;
- lavorazione accurata in tutte le fasi;
- alto livello di artigianalità;
- massima sostenibilità ambientale nel processo di produzione.

since
100% made in Italy **1967**

For us, Made in Italy is the most authentic reflection of the Italian culture and the positive attitudes that we always carry with us and effect our every day life. It is more than just a quality certificate. This is evident in the humans relationships and friendships we establish with our clients and in our constant search for beauty even in every details. Our door handles and accessories for doors and windows has been for years spokespersons of the Italian Design:

- highest quality raw materials;
- great attention to the development of the details of our products;
- great attention to all stages of product processing;
- high level of craftsmanship;
- maximum environmental sustainability in the production process.



PIERGIACOMO PASINI
Planning and Production Manager.

FLORIDO PASINI
Fondatore e Presidente onorario.

ICARO PASINI
General Manager.

Creare è la nostra filosofia, Serietà è la nostra priorità, Dinamismo è la nostra forza. Distinguersi, è l'opportunità che vi diamo...

Creating is our philosophy, Seriousness is our priority, Dynamism is our strength. Stand out, is the opportunity we give you...



PASINI
ITALIAN LUXURY HANDLES

highlights

1967 OFFICINA SIDERURGICA

PFS, Pasini Fratelli Sabbio. Pasini nasce nel 1967 grazie ai fondatori, i fratelli Giuseppe e Florido. Nati come artigiani, fondarono un laboratorio di fusione metalli.

1974 FONDERIA

La fusione e lo stampaggio della barra di ottone forgiata a caldo, iniziate nel 1974, sono attività del processo produttivo altamente monitorate.

1980 ESPANSIONE IN EUROPA

Germania e paesi scandinavi sono i primi avamposti fuori dall'Italia conquistati dai fratelli Pasini, inizia l'espansione verso nuove frontiere.

1995 CREAZIONE PRIMI MODELLI CLASSICI LYBRA E DIANDRA

Inizia la collaborazione con il designer Angelo Dolcetti con la creazione dei primi modelli classici Lybra e Diandra.

1997 PASINI METALS PRODUCTIONS SRL

Nasce la Pasini Metals Productions srl, la seconda generazione entra ufficialmente a guidare l'azienda.

2007 COLLABORAZIONE CON L'UNIVERSITÀ DEL DESIGN POLITECNICO DI MILANO

2007 COMPASSO D'ORO

La maniglia Plus è finalista del concorso Compasso d'oro.

2012 ATTENZIONE ECOLOGICA

Nel 2012 è stato installato un impianto fotovoltaico che soddisfa una buona fetta del fabbisogno della produzione di Pasini.

2014 BEST PRODUCT AL BELARUS DESIGN AWARD

La maniglia di design Milano vince il premio di Best Product al Belarus Design Award.

2016 MANIGLIE E MANIGLIONI CUSTOM MADE PER FORNITURA AL PALAZZO PRESIDENZIALE DI ABU DHABI

2020 RICERCA SU MATERIALI ANTIBATTERICI

1967: PASINI CAME TO BEING AS SIDERURGICAL WORKSHOP

PFS, Pasini Fratelli Sabbio, came to being in 1967 as a fruit of its founders brothers Giuseppe and Florido. Originally craftsmen in the field of metal polishing, they managed to organize and launch on the market an original and very competitive production of handles.

1974: THE FOUNDRY

The fusion and the stamping of the heat forged brass are closely monitored activities that make up the production process.

1980: EUROPE EXPANSION

Germany and Scandinavian countries are the first areas out of the Italian borders where Pasini starts its distribution, here starts the expansion.

1995: CREATIONS OF THE FIRST CLASSICAL MODEL OF LYBRA AND DIANDRA

Starts the collaboration with the designer Angelo Dolcetti with the creation of the first models of the Classique Line: Lybra and Diandra.

1997: PASINI METALS PRODUCTIONS SRL

Date of birth of Pasini Metals Productions s.r.l., the second generation takes over the family business.

2007: COLLABORATION WITH UNIVERSITY OF MILAN

2007: COMPASSO D'ORO

The handle Plus, is finalist at the Compasso d'oro award.

2012: RESPECT FOR THE ENVIRONMENT

In 2012 is been installed a photovoltaic system that satisfy a good part of Pasini needs.

2014: BEST PRODUCT AL BELARUS DESIGN AWARD

The door handle Milano of the i-Design line, wins the price as Best Product at the Belarus Design Award.

2016 CUSTOM MADE HANDLES AND PULL HANDLES FOR ABU DHABI PRESIDENTIAL PALACE

2020 ANTIBACTERIAL MATERIALS RESEARCH



1974 Fonderia



1967 Officina Siderurgica



2012 Impianto Fotovoltaico

Le nostre maniglie e maniglioni sono da anni portavoce del design italiano. La costante ricerca del bello che caratterizza il nostro processo produttivo rende i prodotti Pasini un autentico riflesso della cultura italiana.

Our elegant door handles and pull handles represent the Italian design all over the world. The constant search for beauty and perfection that characterizes our production process, makes Pasini products an authentic reflection of Italian culture.



PASINI
ITALIAN LUXURY HANDLES

our values

LOCALITÀ E GLOBALITÀ

La nostra azienda si trova esattamente nel mezzo delle valli bresciane, nel distretto produttivo della lavorazione dei metalli. Le nostre maniglie sono tuttavia presenti in oltre 30 Paesi del mondo.

CREATIVITÀ

La nostra è un'impresa dinamica e questo ci permette di soddisfare appieno e prontamente i bisogni dei nostri clienti. I nostri ingegneri e designer lavorano a stretto contatto con te, per cogliere qualsiasi esigenza e attuarla.

LE NOSTRE RADICI

La nostra famiglia lavora nel settore dell'ottone da oltre 50 anni e da allora proponiamo da sempre soluzioni scaturite da un saldo connubio tra tradizione e innovazione.

RISPETTO PER L'AMBIENTE

La valle pedemontana che ospita la nostra produzione è per noi fonte di profonda ispirazione: vogliamo preservarla intatta, sia per i nostri figli che per la nostra comunità. Per questo siamo sempre alla ricerca di nuove soluzioni che rispettino l'ambiente e il territorio.

DISTINZIONE

Le certificazioni di cui sono dotati tutti i nostri prodotti, come il più recente Certilogo, garantiscono l'adesione ad alti standard di qualità rispondenti alle vigenti normative europee. Lungo il nostro percorso garantiamo una continua supervisione, dalla produzione alla lavorazione, assicurando così un'eccellente qualità ai nostri clienti.

DINAMISMO E ATTENZIONE AL CLIENTE

I nostri prodotti rispondono ad ogni esigenza, da maniglie e maniglioni di lusso di alta gamma a soluzioni più accessibili e di facile installazione, spaziando dallo stile più sofisticato a quello più sobrio, tra tradizione e innovazione.

LOCALITY E GLOBALITY

Our company is situated exactly in the middle of the Brescia valley, in the district of the metals working. However our door handles and accessories are present in more than 30 countries all over the world.

CREATIVITY

Our door handle company is very dynamic and this allow us to satisfy the need of our clients. Our engineers and designers work with you to understand every demand and need and realize it.

OUR ORIGINS

Our family works in the brass field for over 50 years and since than we always propose a production between tradition and innovation.

ENVIRONMENT RESPECT

The valley where we are sitated is a source of inspiration: we want to preserve it, for our children and for our community. It is for this reason that we are always looking for new enviromentally-friendly solutions.

CERTIFICATIONS

Our products are certified and reach the highest quality standard accordingly to the European law PrEn 1906:2007. We certify that our products are completely projected and manufactured in Italy. We guarantee a continuous supervision of all our productive process assuring our clients an excellent quality.

DINAMISM AND ATTENTION TO THE CLIENT

Our products suit every clients request, from the high line of luxury handles and pull handles to the easy to install solution, from the most sophisticated style to the more minimal one, between tradition and innovation.

Antimicrobial
Copper **Cu⁺**



PASINI
ITALIAN LUXURY HANDLES
Antimicrobial Solution Silver Coat™



PASINI
ITALIAN LUXURY HANDLES
Antimicrobial Solution Copper Coat™



PASINI
ITALIAN LUXURY HANDLES
Antimicrobial Solution Copper Coat™

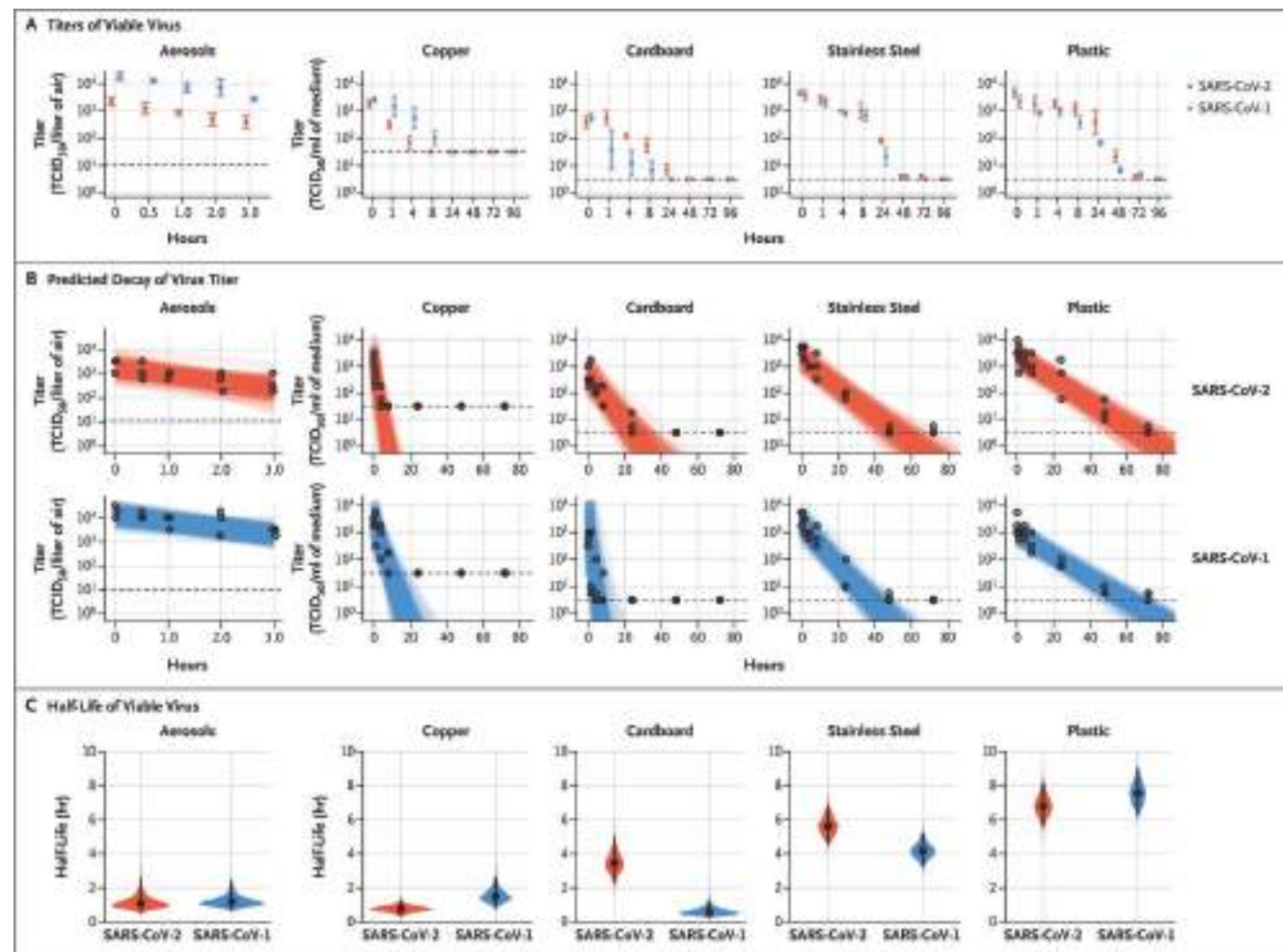

Fonte US National Institute of Allergy and Infectious Diseases Hamilton MT
Source US National Institute of Allergy and Infectious Diseases Hamilton MT



PASINI
ITALIAN LUXURY HANDLES

antibacterial

Da sempre per le maniglie e i maniglioni che realizziamo alla Pasini utilizziamo ottone, un metallo nobile con una alta percentuale di rame, che è riconosciuto come il materiale antibatterico per eccellenza. Questo significa che le maniglie così realizzate producono una azione antibatterica molto efficace. Nel corso degli anni la ricerca effettuata sui materiali ha portato la Pasini a sviluppare prodotti con altri materiali antibatterici come ad esempio il Corian®, confermando la sensibilità della nostra azienda a questo tema. Quest'anno in collaborazione con i nostri designer abbiamo voluto fare un passo in più con due nuove collezioni di maniglie per porte e finestre, a tutti gli effetti antimicrobiche, poiché realizzate in rame puro al 100% (**Antimicrobial Copper Cu+**). Di fatto il rame è stato la prima (e finora l'unica) **superficie metallica antimicrobica approvata dall'EPA** (l'agenzia ambientale americana). Gli studi pubblicati dal Copper Alliance Institute indicano chiaramente che le qualità del rame riducono ed **elimano fino al 99,9% dei batteri**, entro due ore dal contatto. In sintesi i valori aggiunti delle nostre maniglie Pasini con il marchio **Antimicrobial Copper Cu+**:

- **Efficacia:** La maniglie Pasini in ottone e rame hanno una azione antimicrobica più efficace rispetto alle maniglie in alluminio, zama e acciaio con verniciature a base di ioni di argento.
- **Sicurezza scientifica:** le prove scientifiche realizzate su superfici metalliche con almeno il 60% di rame, da diversi laboratori internazionali e verificate in modo indipendente e approvata dalla US Environmental Protection Agency (EPA), dimostrano la capacità del rame di uccidere in modo continuo batteri e virus, anche molto pericolosi, che causano infezioni.
- **Resistenza:** una forte azione antimicrobica che rimane invariata nel tempo e resta efficace in condizioni difficili, anche dopo ripetute abrasioni a secco e umide, contaminazioni, ossidazione naturale e lavorazioni meccaniche.
- **Ottone, Corian®, rame:** confermano la nostra azienda all'avanguardia nel settore delle maniglie antimicrobiche.

Since ever, at Pasini, we use brass material to create our handles and pull handles. Brass is a metal alloy with a high percentage of copper that is an antibacterial material par excellence, this means that our brass handles have an effective antibacterial action. Over the years, Pasini did different researchs looking for new materials, developing handles with other antibacterial material as Corian®, confirming our company as sensitive to antibacterial research. This year, in collaboration with our designers, we did a further step certifying two new collections of handles produced in 100% copper with **Antimicrobial Copper Cu+**. This means that these handles are at all effects **antimicrobial handles**. In fact, copper is the first (and so far the only) **antimicrobial metal surface approved by the US EPA** (United States Environmental Protection Agency). Studies published by the Copper Alliance Institute clearly indicate that copper qualities reduce and **eliminate up to 99.9% of bacteria** within two hours of contact. Summary of added values of Pasini handles with the brand **Antimicrobial Copper Cu+**:

- **Efficacy:** The brass and copper Pasini handles have a more effective antimicrobial action than aluminum, zamak and steel handles with silver-ion based paints.
- **Scientific safety:** scientific tests carried out on metal surfaces with at least 60% copper, by several international laboratories approved by the US Environmental Protection Agency (EPA), demonstrate the ability of copper to kill bacteria and viruses, even very dangerous, that cause infections.
- **Resistance:** a strong antimicrobial action that remains unchanged over time and effective in difficult conditions, even after repeated dry and wet abrasions, contamination, natural oxidation and mechanical machining.
- **Brass, Corian®, copper:** confirm our company at the forefront in the field of antimicrobial handles.

Produciamo con responsabilità
riducendo gradualmente la nostra
impronta ecologica.

We produce with responsibility
gradually reducing our own ecological footprint.



PASINI
ITALIAN LUXURY HANDLES

eco-friendly

Recent archaeological finds, prove that copper has been worked in our valley for over 4,000 years. This means that in our brass handles, a metal alloy with at least 56% of copper, is present an ancient metal still recyclable nowadays.

APPROVVIGIONAMENTO DELLA MATERIA PRIMA

L'ottone, il materiale per eccellenza della produzione Pasini, è un metallo che a differenza di molti altri può essere riciclato all'infinito senza perdere le sue proprietà. Tutto il metallo ottone che utilizziamo per realizzare le nostre maniglie è prodotto con materiale proveniente da precedenti lavorazioni e manufatti. Inoltre la materia prima che riceviamo dai nostri fornitori è certificata con contenuto di piombo inferiore al 2%.

PROCESSO DI PRODUZIONE

Gli sfridi metallici che si creano durante le lavorazioni vengono rimessi nel ciclo produttivo per futuri riutilizzi. Tutti i rifiuti che escono dalla fabbrica vengono prima suddivisi, differenziati e poi consegnati a riciclatori industriali per futuri riutilizzi (pallet in legno, cartone, imballi di plastica). Dal 2012 il nostro stabilimento produttivo è dotato di un impianto fotovoltaico in grado di auto sostenere il fabbisogno energetico di buona parte della produzione. Da gennaio 2020 l'energia consumata è proveniente per la quasi totalità, da fonti rinnovabili, il che, unito all'energia venduta tramite l'impianto fotovoltaico, ci trasforma di fatto in un'azienda produttrice di energia rinnovabile.

PACKAGING E SERVIZIO DI SPEDIZIONE

Da sempre ottimizziamo la disposizione del prodotto sul pallet, in modo tale da ottenere un miglior rendimento grazie al maggior numero di colli collocabili. Per quanto riguarda il packaging delle nostre maniglie abbiamo incorporato nuovi imballaggi ecologici e riciclabili.

RIUTILIZZO E RICICLO

Le nostre maniglie, hanno una lunga durata di utilizzo e alla sua fine possono rientrare integralmente nel ciclo produttivo dei metalli. Tuttavia con il passare del tempo mantengono la loro eleganza trasformandosi in prestigiosi oggetti di antiquariato.

Recent archaeological finds, proves that copper has been worked in our valley for over 4,000 years. This means that in our brass handles, a metal alloy with at least 56% of copper, is present an ancient metal still recyclable nowadays.

SUPPLY OF RAW MATERIALS

Solid brass, the excellence material of the Pasini production, is a metal that, unlike many other materials, can be indefinitely recycled, without losing its properties. All brass we use to make our handles is produced with material coming from previous processes and artifacts. Furthermore raw material we receive from our suppliers is certified with a lead content of less than 2%.

PRODUCTION PROCESS

The metal scraps, that are created during processing, are put back into the production cycle for future reuse. All the waste that comes out of the factory is first divided, differentiated and delivered to industrial recyclers for future reuse (wooden pallets, cardboard, pallet packaging). Since 2012 our production plant has been equipped with a photovoltaic system able to self-sustain the energy needs of all production. From January 2020, the energy consumed is almost entirely from renewable sources, which, together with the energy sold through the photovoltaic system, transforms us into a renewable energy producer.

PACKAGING AND SHIPPING SERVICE

We have always optimized the arrangement of the product on the pallet, in order to obtain a higher yield thanks to the greater number of packages that can be placed. As for the packaging of our handles we have incorporated new eco-friendly and recyclable packaging.

REUSE AND RECYCLING

Our door handles have a long lasting, but at the end of their life, they can be fully integrated in a new metals production cycle. However with the passing of time they maintain their elegance becoming a prestigious antiquity.



Assicurati dell'autenticità delle maniglie Pasini

[Authenticate PFS Pasini handles](#)

Pasini è la prima maniglieria al mondo a certificare l'originalità dei propri prodotti grazie alla collaborazione con Certilogo, azienda specializzata nell'anticontraffazione, utilizzata dai marchi di moda più prestigiosi al mondo. Attualmente più di 50 marchi si servono di questa certificazione, per garantire a più di un milione di clienti l'originalità dei propri prodotti e combattere la contraffazione.

Grazie al sigillo di sicurezza Certilogo, ogni singolo pezzo viene marchiato e tracciato, creando una vera e propria carta d'identità del prodotto.

Per accertarsi che il prodotto acquistato sia un originale prodotto di PFS Pasini, è sufficiente seguire due semplici passaggi:

- Cerca sui nostri prodotti il marchio Certilogo con il Codice CLG a 12 cifre;
- Esegui una scansione del codice QR attraverso l'app del tuo smartphone, oppure visita il sito di Certilogo e inserisci il Codice associato al prodotto.

Pasini is the first door handle company worldwide to certify the authenticity of its products, thanks to a partnership with CERTILOGO, specialized company employed by the most prestigious brand in the world. Nowadays more than 50 brands use this certification, to ensure their customers the authenticity of their products and help fight counterfeits.

Thanks to a secure seal, every single piece of our production is marked and tracked, creating a real Identity card of the product.

To fully assure that the article you purchased is an authentic PFS Pasini product, it is enough to follow these steps:

- Look for the Certilogo tag on our products with the CGL code of 12 numbers;
- Scan the QR code with your smartphone or visit the Certilogo web site and enter the code associate to the product.

Pasini in the world.



PASINI
ITALIAN LUXURY HANDLES

network

EUROPA: Italia, Belgio, Repubblica Ceca, Armenia, Spagna, Francia, Olanda, Inghilterra, Germania, Grecia, Cipro, Malta, Estonia, Lettonia, Lituania, Russia, Ucraina, Polonia, Bielorussia.

AMERICA: USA

AFRICA: Senegal, Egitto, Libia, Algeria, Tunisia, Marocco.

MIDDLE EAST: Libano, Iran, Siria, Kuwait, Giordania, Israele, U.A.E., Dubai, Arabia Saudita, Qatar, Bahrain, Oman.

FAR EAST: Pakistan, India, Malesia, Indonesia, Taiwan, Cina, Vietnam, Korea, Australia, Sri Lanka, Kazakistan, Thailandia, Uzbekistan, Myanmar.

EUROPE: Italy, Belgium, Czech Republic, Armenia, Spain, France, Netherlands, England, Germany, Greece, Cyprus, Malta, Estonia, Latvia, Lithuania, Russia, Ukraine, Poland, Belarus.

AMERICA: USA

AFRICA: Senegal, Egypt, Lybia, Algeria, Tunisia, Morocco.

MIDDLE EAST: Lebanon, Iran, Syria, Kuwait, Jordan, Israel, U.A.E., Dubai, Saudi Arabia, Qatar, Bahrain, Oman.

FAR EAST: Pakistan, India, Malesia, Indonesia, Taiwan, China, Vietnam, Korea, Australia, Sri Lanka, Kazakhstan, Thailand, Uzbekistan, Myanmar.

Finiture disponibili
Available finishes



PVD Grafite
PVD Graphite



PVD Copper
PVD Copper



Bronzo vintage
Vintage



Cromo
Chrome



Cromo satinato
Satin chrome



Nichel
Nickel



Nichel satinato
Satin Nickel



Oro 24kt
Plated gold



Oro francese
Antique french brass



Oro rosa
Pink gold



Oro sabbato
Brass gold matt



Ottone anticato marrone
Antique silver brass



Ottone anticato scuro
Antique dark brass



Ottone graffiato antico
Yester bronze brass



Ottone graffiato verniciato
Bronze brass



Ottone lucido verniciato
Polished brass



Ottone satinato
Satin brass



PVD satinato
Satin PVD



Peltro
Pewter



PVD



PASINI
ITALIAN LUXURY HANDLES

finishing & materials

LE NOSTRE FINITURE METTONO IN EVIDENZA TUTTA LA BELLEZZA DELL'OTTONE.

Grazie allo speciale strato protettivo trasparente, i colori si mantengono intatti nel tempo, garantendo alla tua maniglia la stessa lucentezza del prodotto nuovo. Per gli amanti del lusso, i prodotti della linea Pasini Jewels presentano finiture in oro, argento e altri materiali preziosi, oltre a particolari inserti in madreperla e cristalli. La vasta disponibilità di pregiati intarsi offre una concreta possibilità di personalizzare le maniglie secondo i più esigenti gusti estetici.

OUR FINISHES HIGHLIGHT ALL THE BEAUTY OF THE BRASS.

Thanks to a special transparent protective layer, our finishes maintain their properties over time, guaranteeing your handles the same brightness of the new product. For the luxury lovers, the products of the Pasini Jewels line have gold, silver finishes and precious materials, among them you can find mother of pearl inserts and crystals. The wide choice of special inserts offer the possibility to customize our door handles and pull handle satisfying also the most demanding taste.



Pelle
Leather



Corian
Corian



Madreperla
Nacre

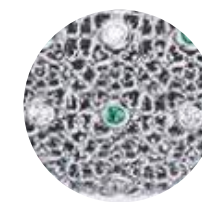

Cristallo
Crystal



Ambra
Amber



Zaffiro
Sapphire

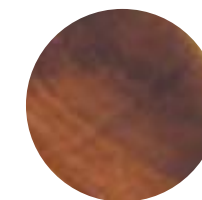

Legno
Wood



Porcellana
Porcelain

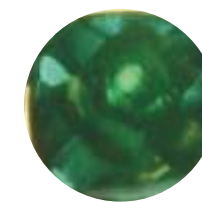

Smeraldo
Emerald

**pasini
jewels**

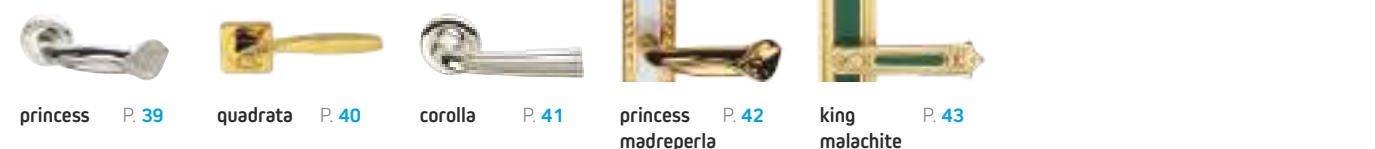
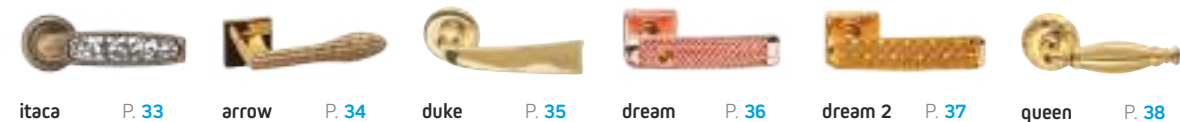

**pasini
classic**

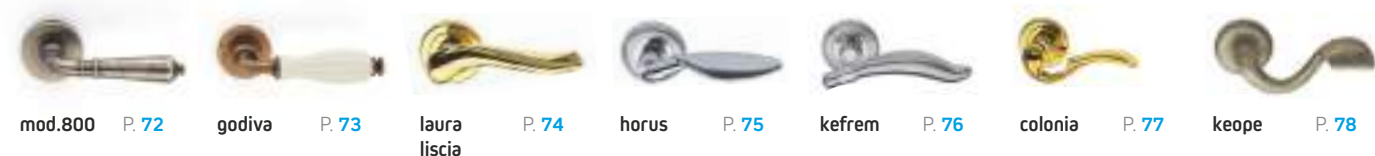
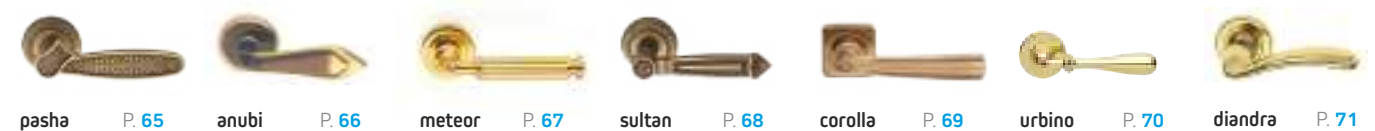

**pasini
design**

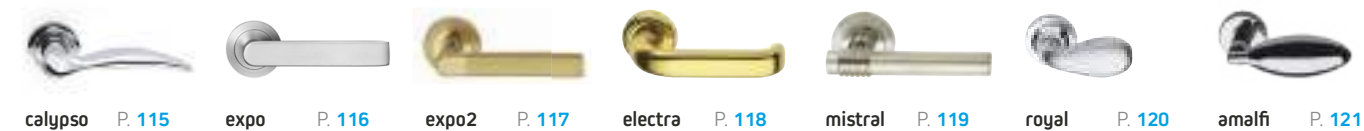
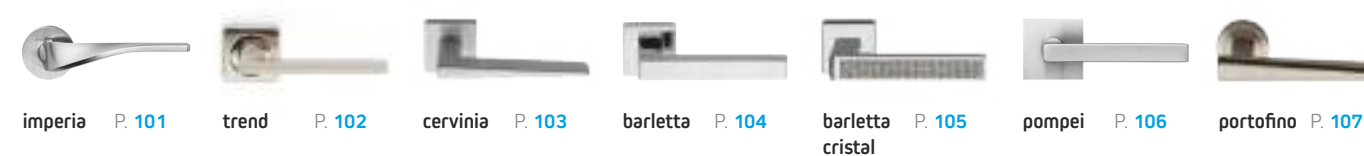
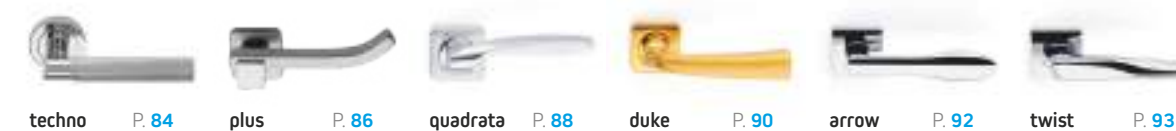

**pasini
essential**

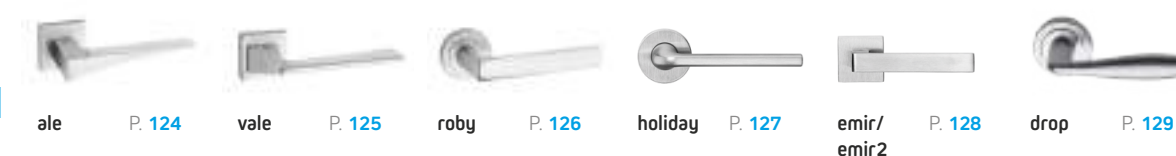

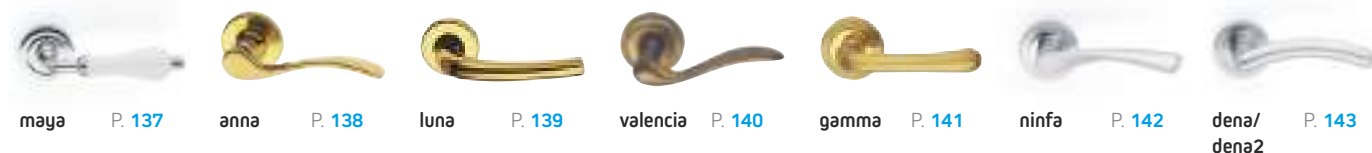

maya P. 137 anna P. 138 luna P. 139 valencia P. 140 gamma P. 141 ninfa P. 142 dena/ dena2 P. 143



pulsar P. 144 alfa P. 145 eco P. 146 piatta P. 147

maniglioni classic



caduceo P. 150 scettro P. 151 minerva P. 152 micerino ros. grande P. 153 micerino ros. piccola P. 154 manila P. 155



manila spostato P. 156 perseo P. 156 mida P. 157 mida spostato P. 157 ulisse P. 158 efeso P. 158 petra P. 159



dafne P. 159 impero P. 160 impero g. rodi P. 161 impero g. dritto P. 162 davao P. 162 creta P. 163 pireo P. 164

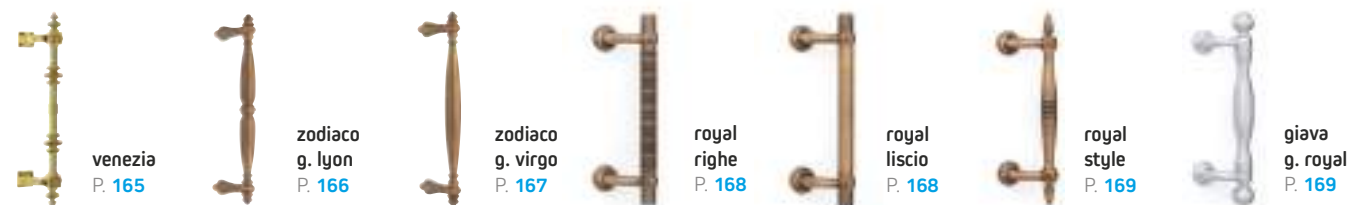

venezia P. 165 zodiaco g. lyon P. 166 zodiaco g. virgo P. 167 royal righe P. 168 royal liscio P. 168 royal style P. 169 giava P. 169



moneta P. 170 rodi P. 170 creta g. tondo P. 171 cipro P. 171 pegaso P. 172 mod.800 g. dritto P. 173 mod.800 g. spostato P. 173

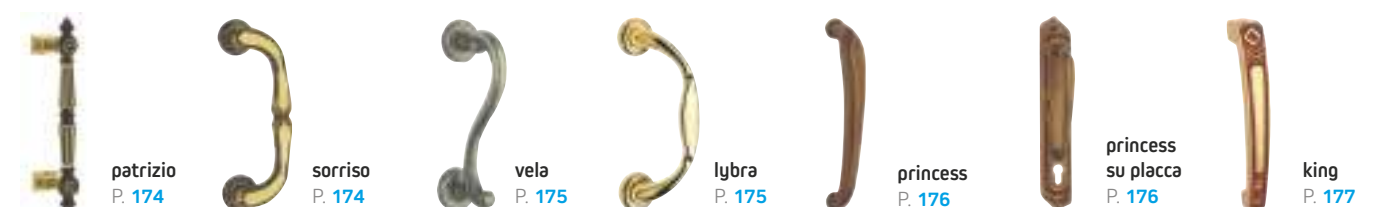

patrizio P. 174 sorriso P. 174 vela P. 175 lybra P. 175 princess P. 176 princess su placca P. 176 king P. 177



olimpia P. 177 alzante scorrevole P. 178 alzante ovale P. 179

maniglioni design



delfino P. 181 airone P. 182 pantera P. 183 techno P. 184 techno grip P. 186 galassia P. 188



spazio P. 188 antares quadrato P. 189 orion inox P. 189 polluce P. 190 marte P. 191 venere P. 191 rimira P. 192



rimira con defender P. 192 arona P. 193 luna P. 193 trend P. 194 aquarius P. 194 windows arco P. 195 windows dritto P. 195



cono P. 196 giava P. 196 esagonale P. 197 semitondo P. 197 micene P. 198 berlino P. 199 giza P. 200



zeta P. 200 quadrato P. 201 quadrato su placca P. 201

handle maniglie

ale	P. 124	horus	P. 75	roby	P. 126
alfa	P. 145	idro	P. 110	royal	P. 110
amalfi	P. 121	imperia	P. 101	siena	P. 62
anna	P. 138	itaca	P. 33	sirio	P. 32
anubi	P. 66	katana	P. 109	sitia	P. 38
arrow pasini jewels	P. 34	kefrem	P. 76	sorrento	P. 68
arrow pasini design	P. 92	keope	P. 78	star	P. 159
asolo	P. 111	king malachite	P. 43	sultan	P. 136
barletta	P. 104	king pasini classic	P. 50	techno	P. 159
barletta crystal	P. 105	laura liscia	P. 74	torino	P. 136
bellagio	P. 112	liberty	P. 63	tratto	P. 150
bermuda	P. 114	lucy	P. 135	trend	P. 94
calypso	P. 115	luna	P. 139	twist	P. 96
cernobbio	P. 113	maya	P. 137	udine	P. 92
cervinia	P. 103	meteor	P. 67	urbino	P. 108
cleopatra	P. 79	milano	P. 97	vale	P. 34
colonia	P. 77	mistral	P. 119	valencia	P. 22
corolla pasini classic	P. 69	mod.800	P. 72		
corolla pasini jewels	P. 41	musa	P. 46		
cuprum	P. 62	ninfa	P. 142		
dafne	P. 48	pasha	P. 65		
delta	P. 136	patrizio	P. 54		
dena / dena 2	P. 143	pegaso	P. 47		
diandra	P. 71	pesaro	P. 96		
diva	P. 131	petra	P. 49		
dream	P. 36	piatta	P. 147		
dream 2	P. 37	planet	P. 133		
drop	P. 129	plus	P. 86		
duke pasini jewels	P. 35	pompei	P. 106		
duke pasini design	P. 90	portofino	P. 107		
eco	P. 146	prima	P. 94		
eden	P. 64	princess madreperia	P. 42		
electra	P. 118	princess pasini classic	P. 56		
emir / emir 2	P. 128	princess pasini jewels	P. 39		
expo	P. 116	pulsar	P. 144		
expo2	P. 117	quadrata pasini design	P. 88		
gamma	P. 141	quadrata pasini jewels	P. 40		
giza	P. 132	queen pasini jewels	P. 38		
godiva	P. 73	queen pasini classic	P. 58		
holiday	P. 127	ramses	P. 52		

pull-handle
maniglioni

acquarius	P. 194	olimpia	P. 177
airone	P. 182	orion	P. 189
alzante sc. ovale	P. 179	pantera	P. 183
alzante sc. quadrato	P. 178	patrizio	P. 174
antares quadrato	P. 189	pegaso	P. 172
arona	P. 193	perseo	P. 156
berlino	P. 199	petra	P. 159
caduceo	P. 150	pireo	P. 164
cipro	P. 171	polluce	P. 190
cono	P. 196	princess	P. 176
creta	P. 163	princess su placca	P. 176
creta g. tondo	P. 171	quadrato	P. 201
dafne	P. 159	quadrato su placca	P. 201
davao	P. 162	rimira	P. 192
delfino	P. 181	rimira con defender	P. 192
efeso	P. 158	rodi	P. 170
esagonale	P. 197	royal liscio	P. 168
galassia	P. 188	royal righe	P. 168
giava	P. 196	royal style	P. 169
giava g. royal	P. 169	scettro	P. 151
giza	P. 200	semitondo	P. 197
impero	P. 160	sorriso	P. 174
impero g. dritto	P. 162	spazio	P. 188
impero g. rodi	P. 161	techno	P. 184
king	P. 177	techno grip	P. 186
luna	P. 193	trend	P. 194
lybra	P. 175	ulisse	P. 158
manila	P. 155	vela	P. 175
manila spostato	P. 156	venere	P. 191
martè	P. 191	venezia	P. 165
micene	P. 198	windows arco	P. 195
micerino rosetta grande	P. 153	windows dritto	P. 195
micerino rosetta piccola	P. 154	zeta	P. 200
mida	P. 157	zodiaco g. lyon	P. 166
mida spostato	P. 157	zodiaco virgo	P. 167
minerva	P. 152		
mod.800	P. 173		
mod.800 g. spostato	P. 173		
moneta	P. 170		



PASINI
ITALIAN LUXURY HANDLES

Pasini Custom Made

Realizzazione di maniglie e maniglioni personalizzati
Il tuo cuore, la tua idea, le nostre mani: per realizzare la tua opera d'arte unica e irripetibile.

Realization of customized door handle and pull handles and accessories. Your heart, your idea, our hands to realize your unique masterpiece.

IL TUO SOGNO

Raccontaci il tuo desiderio, la tua idea, lo stile ed i materiali da utilizzare. Insieme creiamo una bozza. Basta l'indicazione sui materiali da utilizzare e sullo stile con cui vuoi che venga realizzata la maniglia. Noi pensiamo al resto.

DESIGN

La tua idea viene passata al vaglio dei nostri ingegneri e designer che, attraverso uno studio meticoloso, la adattano sia nel design che nella realizzazione. La fase di progettazione è lo step fondamentale, in cui avviene la preparazione di tutte le fasi successive della lavorazione. È in questo preciso punto che la maniglia che prima era semplicemente un desiderio recondito, ora inizia concretamente a prendere forma.

PROTOTIPO

Tramite una stampante 3D o direttamente realizzato a mano in creta dal nostro scultore, viene creato un prototipo della maniglia o del maniglione desiderato. A seguire, il progetto ti viene inviato per accertare la piena realizzazione della tua idea.

CONCRETEZZA DEL PRODOTTO

Ora che il prototipo è stato ultimato, i nostri designer realizzano il disegno definitivo della tua idea che sarà poi seguito nel minimo dettaglio durante la produzione.

LA TUA CREAZIONE

È l'ultimissima fase che dona realtà alla tua idea ed esaudisce definitivamente il tuo desiderio.

YOUR DREAM

Tell us your desire, your idea, the style and the materials to use, together we create a preliminary draft, it is enough to tell us which material you want to use and the style you prefer. We take care of the rest.

DESIGN

Our idea is carefully examined from our engineers and designer that make it became possible. The design phase is the most important step, where all the entire process is planned. It is at this stage that what it was only a dream comes to life.

PROTOTYPE

Thanks to a 3-D printer or handmade in clay from our sculptor, we realize a prototype of your desire object.

THE PRODUCT

Once the prototype is ready, our designer optimized the final drawing of your idea that will be followed in every details during the production phase.

YOUR CREATION

This is the latest phase, that makes your dream comes true.

Pasini Custom Made

STUDIO FOR P. P. P. Abu Dhabi
LUXURY VILLA China
MINISTER PALACE Kazakhstan



PASINI
ITALIAN LUXURY HANDLES

17,5



e-quality

DESIGN AND CONCEPT
Arch. Andrea Frisullo

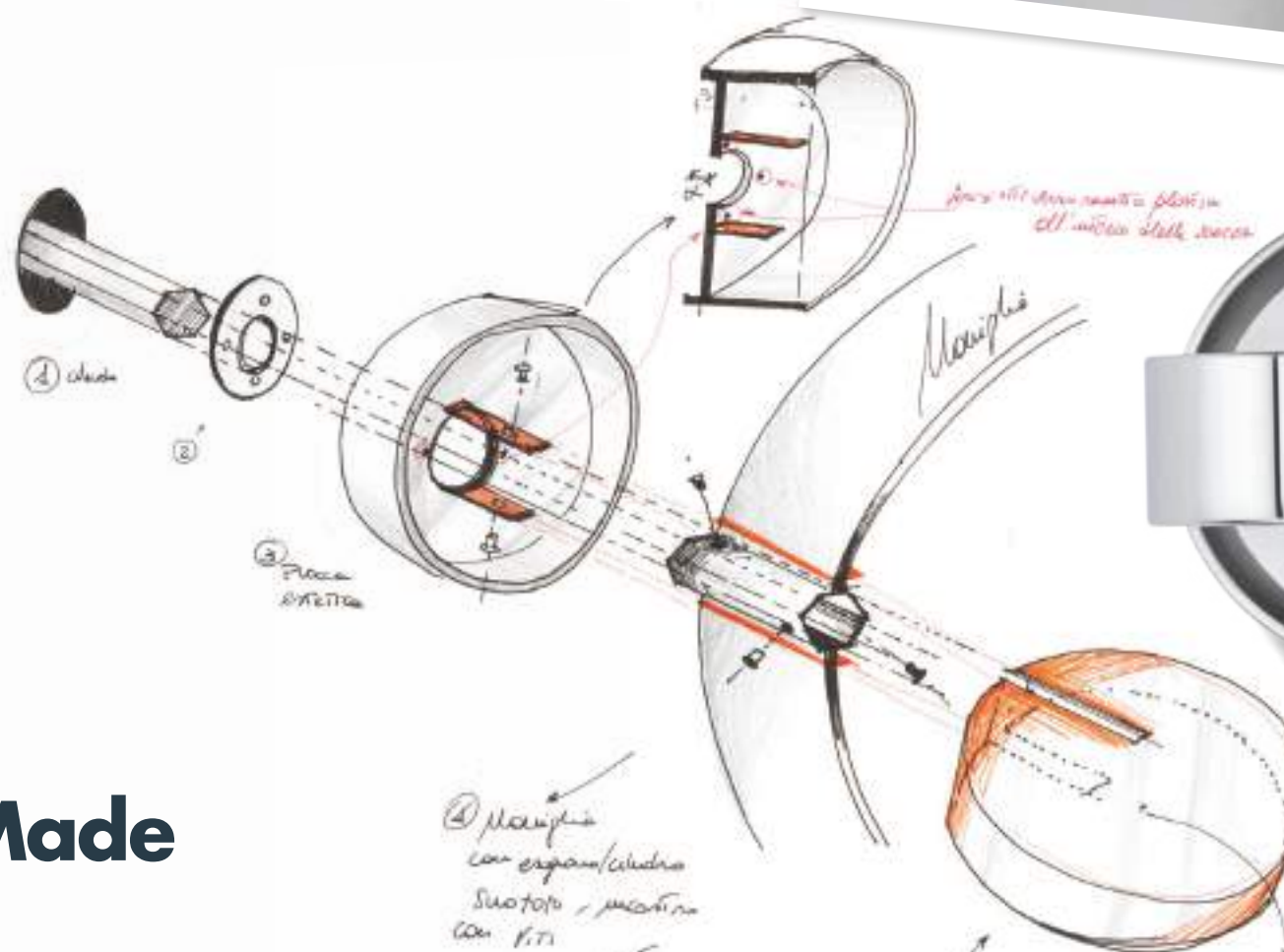
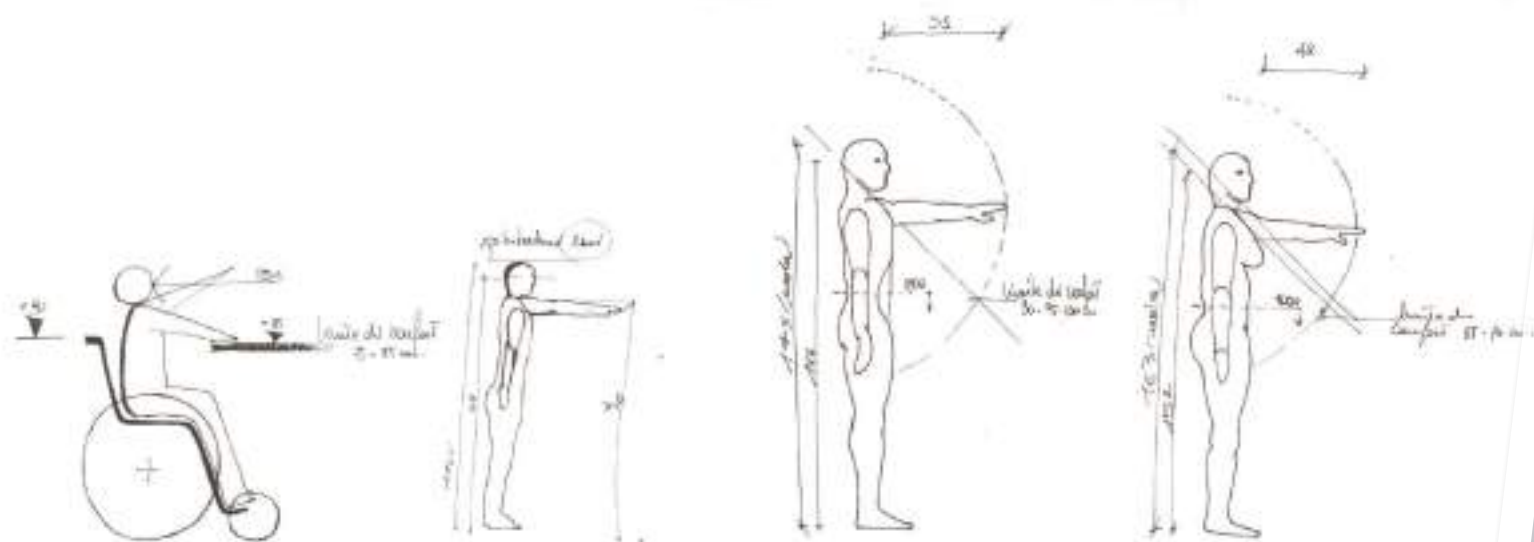

Pasini Custom Made

Model E-QUALITY un nuovo concetto di maniglia basato sull'uguaglianza. Molteplici impugnature pensate per esigenze diverse: Disabile - Donna - Uomo - Bambino. L'architettura del cerchio rappresenta il concetto di uguaglianza - E-QUALITY: Design, ornamento e funzionalità.

Model E-QUALITY a new concept of door handle based on equal rights. Multiple handling created for different needs: Disabled - Woman - Man - Child. The architecture of the circle, represent the concept of equality. E-QUALITY, design, adornment, functionality.

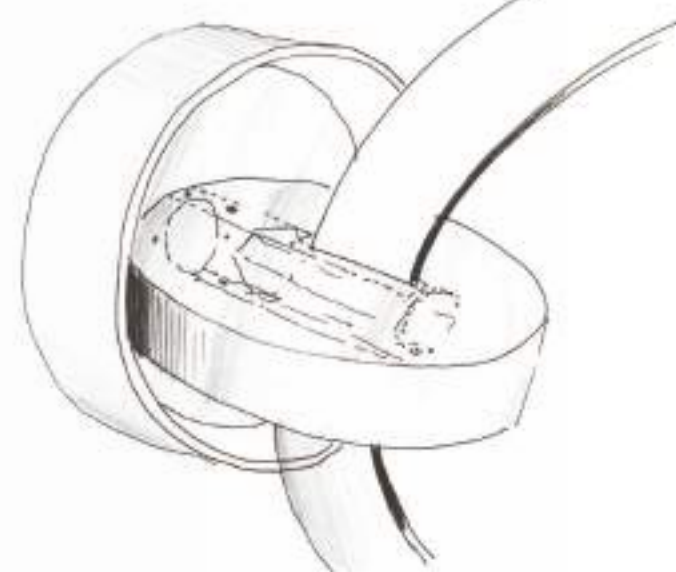



Pasini Jewels
 Maniglie di lusso per
 interni ed esterni.
 Maniglie da
 batticuore.

Pasini Jewels
 Luxury door handles
 for indoor and outdoor.
 Breathtaking handles.

Pasini Jewels

Il lusso più autentico si caratterizza per la sua capacità di diventare un classico e di adattarsi ad ogni epoca. Le maniglie e i maniglioni di questa linea regalano ai tuoi ambienti di lusso un fascino sofisticato. La tecnologia e la qualità di queste maniglie ci permettono di rappresentare l'artigianato Made in Italy in tutto il suo splendore: la linea Pasini Jewels è infatti una perfetta fusione fra la creatività dei nostri designer e la manualità dei maestri orafi, padroni assoluti delle tecniche pavé, stone e prestige. Un design tutto italiano che crea un valore speciale per i gioielli della tua casa.

The most authentic luxury is characterized for its ability to become a classic and to be timeless. The door handles and the pull handles of this line offer to your luxury home a sophisticated charm. The technology and the quality of these handles allowed us to celebrate the real Made in Italy craftsmanship: Pasini Jewels line is, as a matter of fact, a perfect fusion between the creativity of our designers and the ability of our artisans, master of the pavé, stone and prestige techniques. An Italian creation that brings a special value to your home new masterpiece.



itaca

Designer: **Angiolino Dolcetti**
 Material: Solid Brass - Pewter

PASINI JEWELS

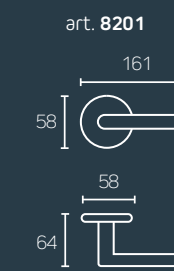
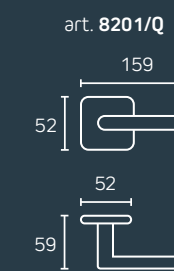
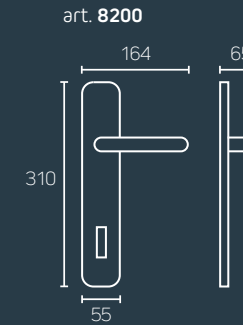

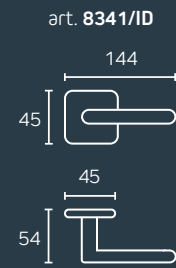

arrow

Designer: **Studio Pasini**
Material: Solid Brass

PASINI JEWELS

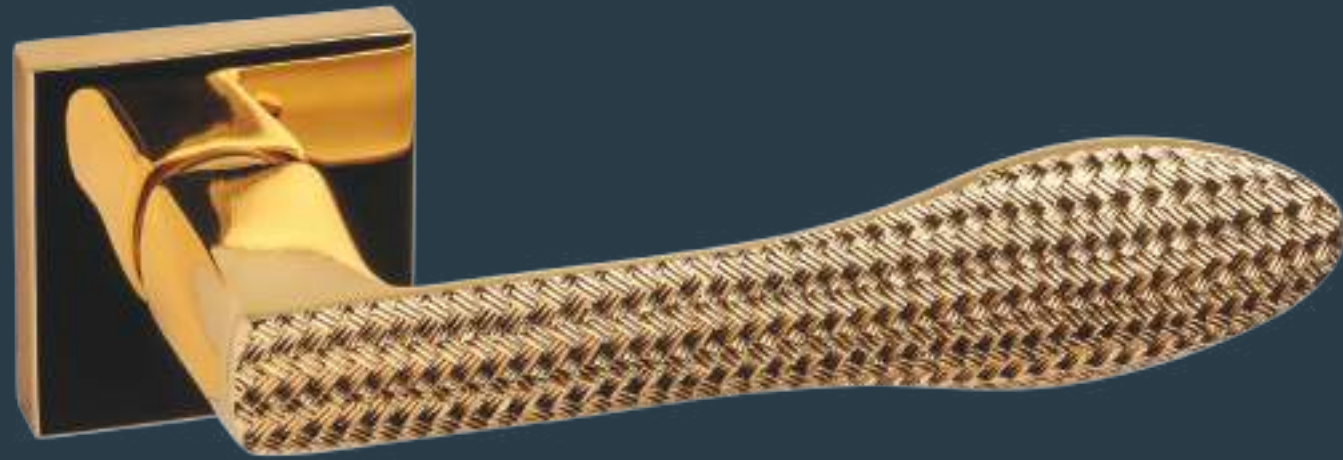

Decorazione: **Tiffany**

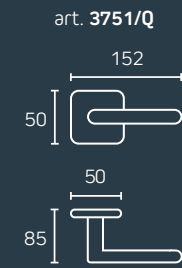

duke

Designer: **Angiolino Dolcetti**
Material: Solid Brass

PASINI JEWELS



Decorazione: **Pavé**

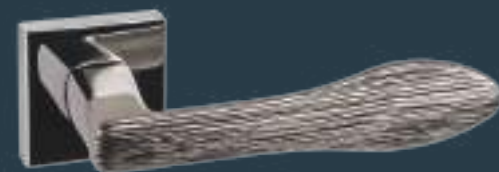
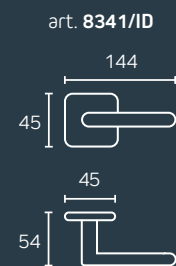

Decorazione: **Rosewood**

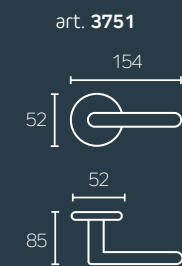

Decorazione: **Pavé**

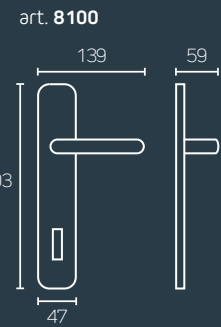

dream

Designer: **Linea Idea**
Material: Solid Brass

PASINI JEWELS

Decorazione: **Dream Amber**

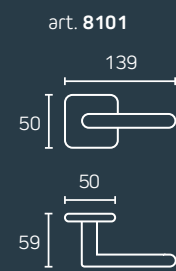

Decorazione: **Dream Sapphire**

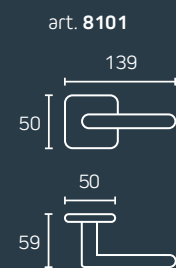

Decorazione: **Dream Emerald**

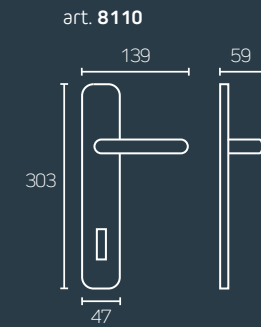

dream2

Designer: **Linea Idea**
Material: Solid Brass

PASINI JEWELS

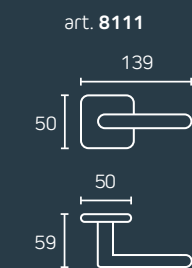
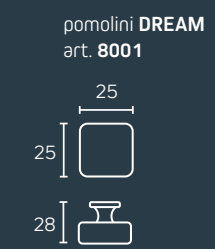

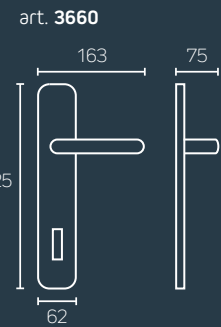

queen

Designer: **Angiolino Dolcetti**
Material: Solid Brass

PASINI JEWELS

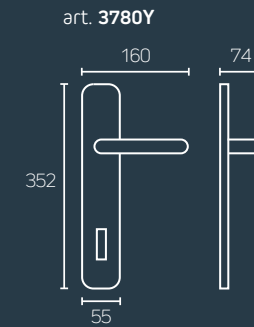
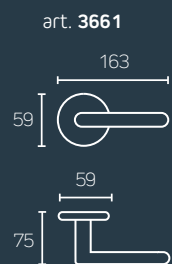

princess

Designer: **Angiolino Dolcetti**
Material: Solid Brass

PASINI JEWELS

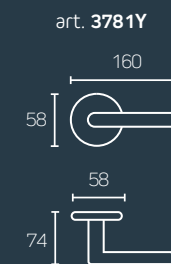

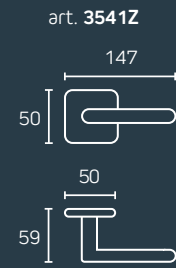

quadrata

Designer: **Angiolino Dolcetti**
Material: Solid Brass

PASINI JEWELS

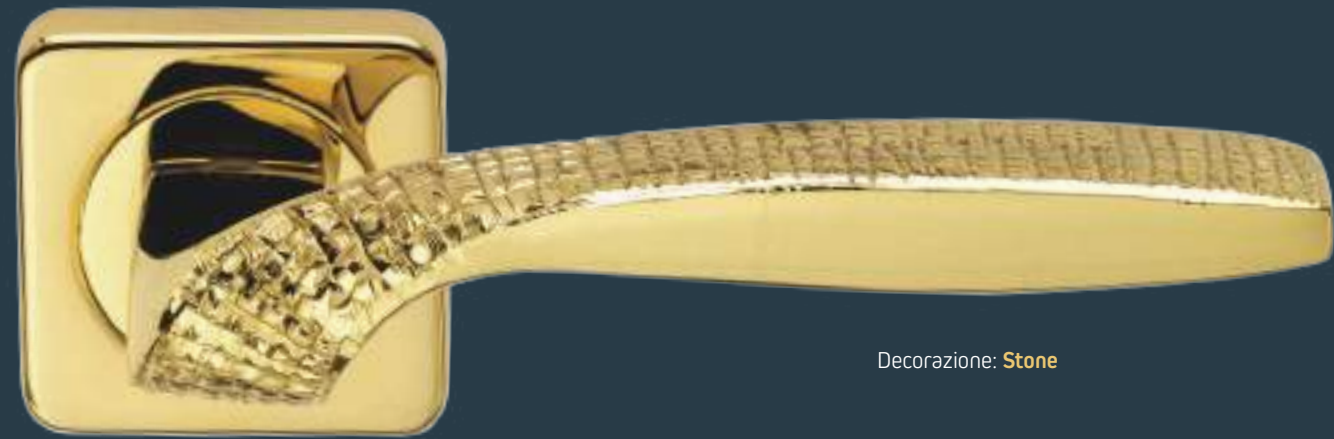

Decorazione: **Stone**

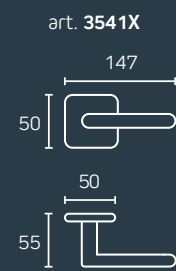

Decorazione: **Prestige**

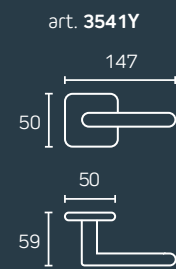

Decorazione: **Pavé**

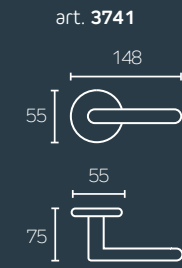

corolla

Designer: **Angiolino Dolcetti**
Material: Solid Brass

PASINI JEWELS



Decorazione: **Pavé**

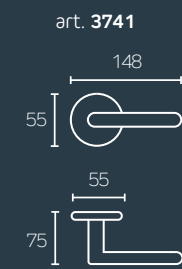

Decorazione: **Pavé**

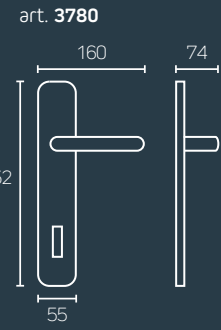

princess

Designer: **Angiolino Dolcetti**
Material: Solid Brass - Mother of Pearl

PASINI JEWELS

Decorazione: **Mother of Pearl**

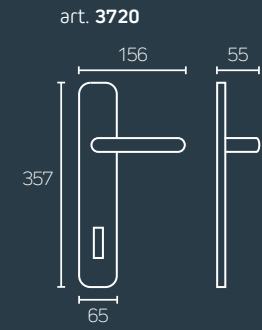
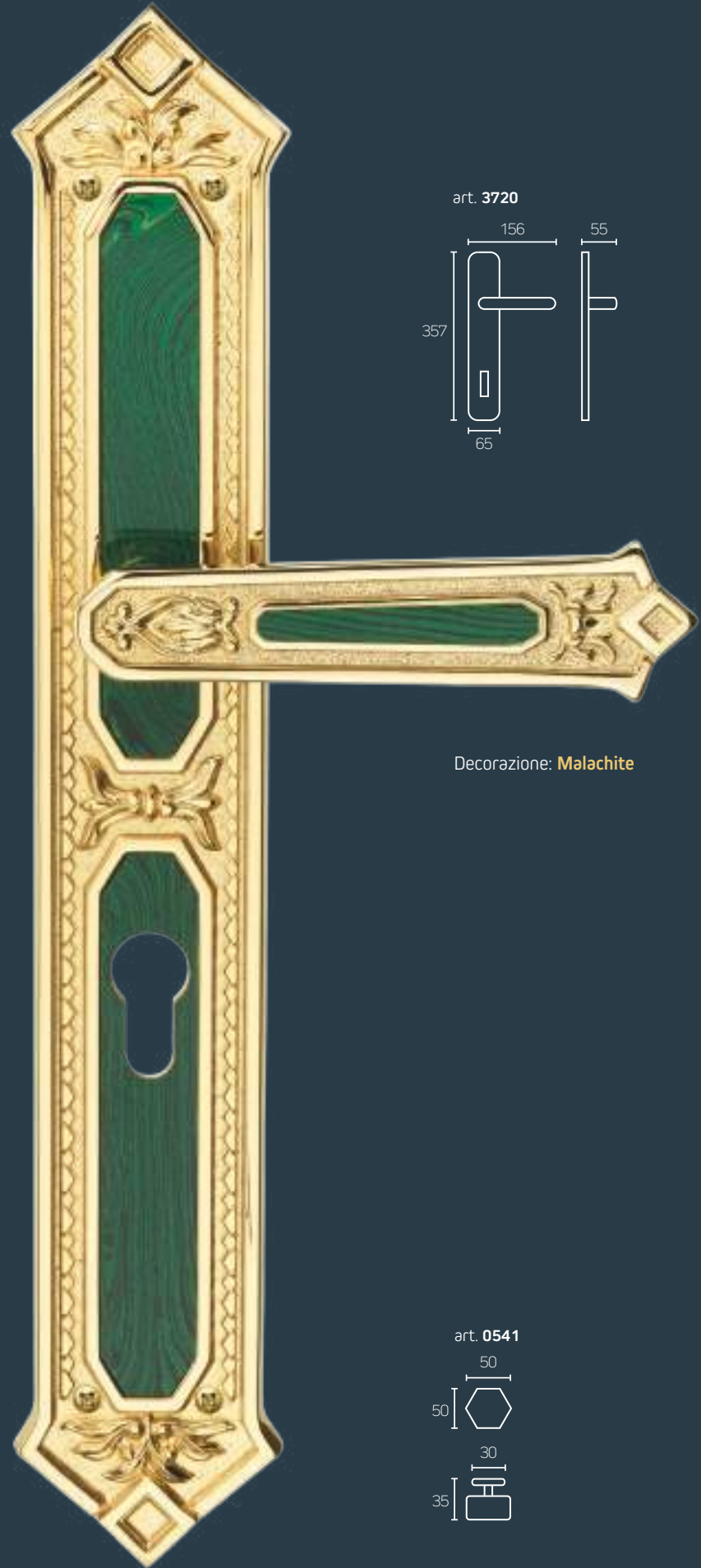
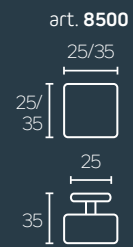

king

Designer: **Angiolino Dolcetti**
Material: Solid Brass - Malachite

PASINI JEWELS

Decorazione: **Malachite**

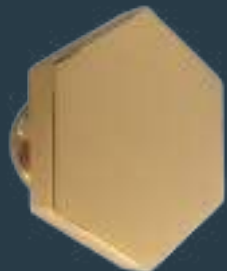
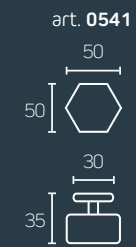

Pasini Classic
Maniglie e maniglioni
originali della
tradizione Pasini
Emozioni senza tempo.

Pasini Classic
Door handles and
pull handles from the
authentic Pasini
Timeless emotion.



PASINI
ITALIAN LUXURY HANDLES

Pasini Classic

Tradizione significa coltivare una passione decennale alla costante ricerca della perfezione. Questo è ciò che rappresenta la linea Pasini Classic: pura espressione dei nostri valori, da più di 50 anni. Lo stile classico che ti rassicura, maniglie prestigiose, creazioni artigianali italiane, che trasmettono il calore e l'atmosfera della tua casa.

Tradition means taking care of a decennary passion at constantly looking for the excellence. This is what the Pasini Classic line represent: pure expression of our values since more than 50 years. This classic style make you feel comfortable and relaxed, prestigious door handles, Italian craftsmanship creations, make you feel the warm atmosphere of your home.

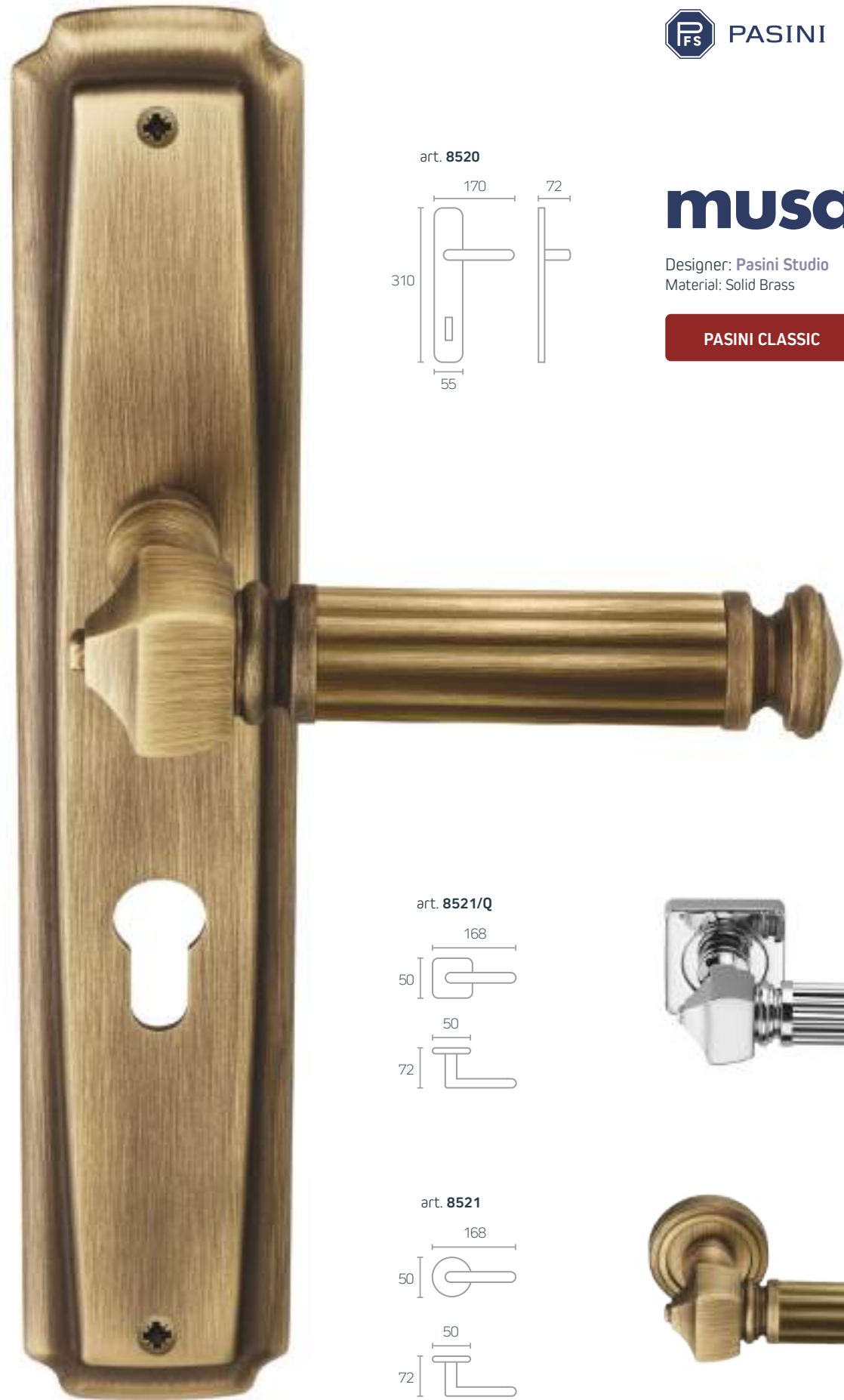

PASINI

musa

Designer: Pasini Studio
Material: Solid Brass

PASINI CLASSIC

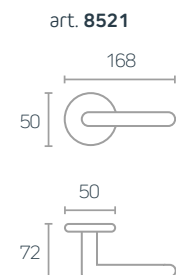
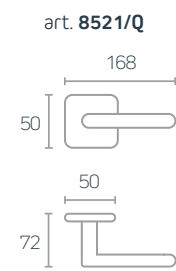
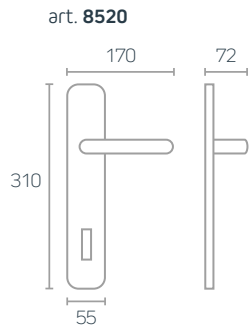

PASINI

pegaso

Designer: Pasini Studio
Material: Solid Brass

PASINI CLASSIC

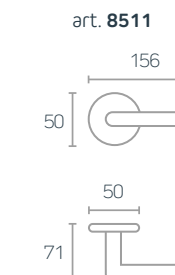
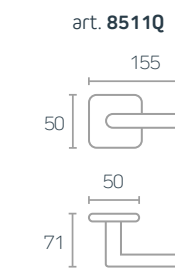
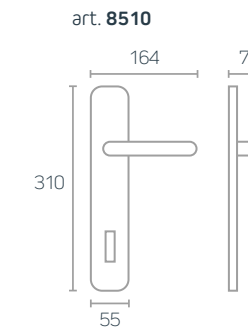

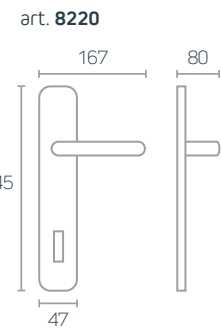
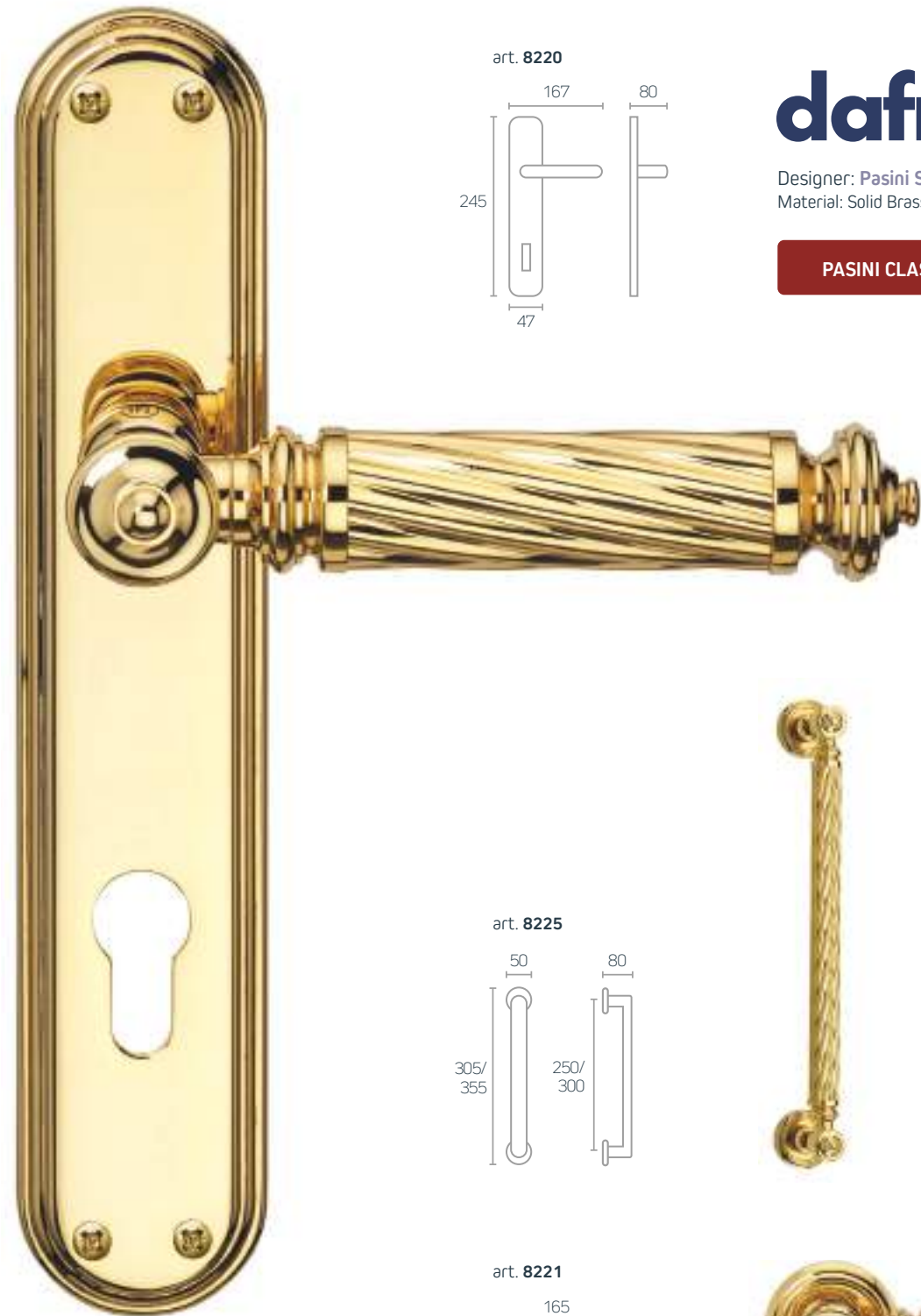

dafne

Designer: Pasini Studio
Material: Solid Brass

PASINI CLASSIC

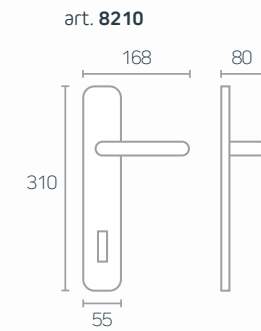
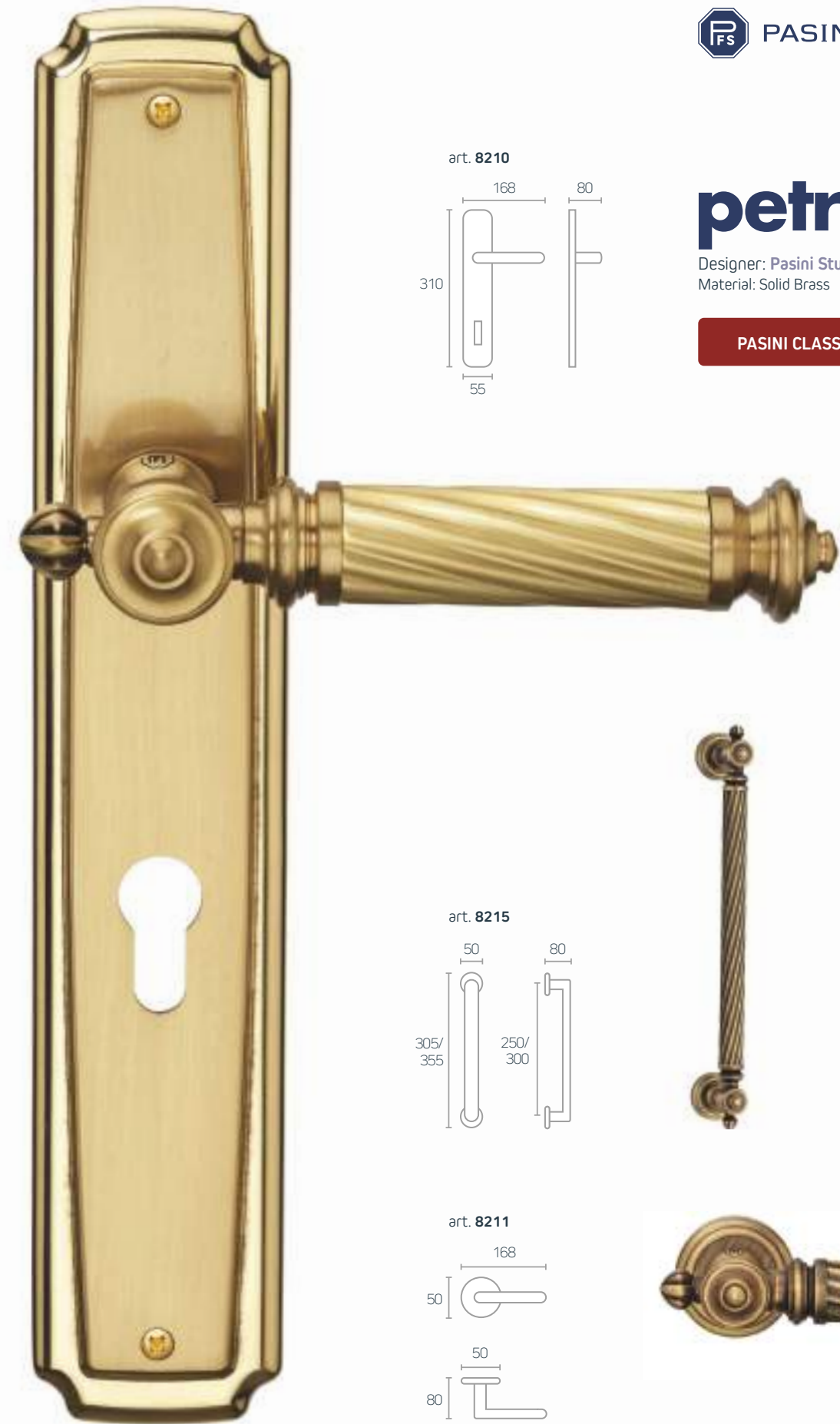
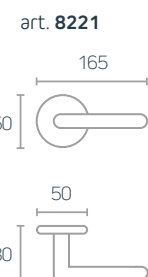
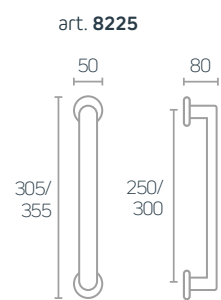

petra

Designer: Pasini Studio
Material: Solid Brass

PASINI CLASSIC

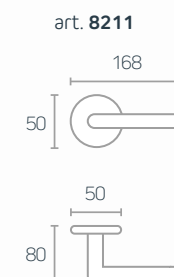
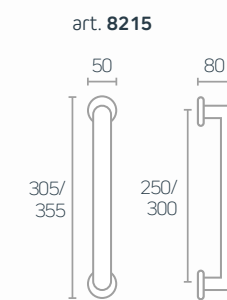

king

Designer: Angiolino Dolcetti
Material: Solid Brass



art. 3721



art. 0430

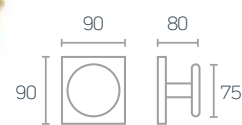

art. 3723

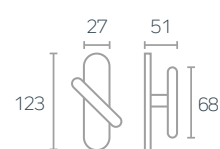

PASINI CLASSIC



PASINI CLASSIC

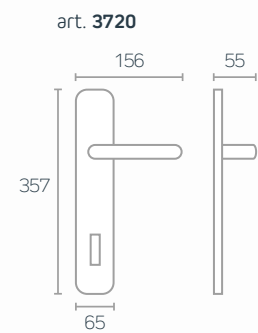

art. 3720

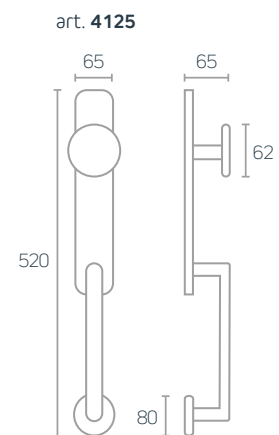

art. 4125

ramses

Designer: Angiolino Dolcetti
Material: Solid Brass



art. 8261/0091

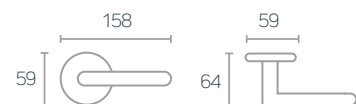

art. 8261



PASINI CLASSIC



PASINI CLASSIC



art. 4140

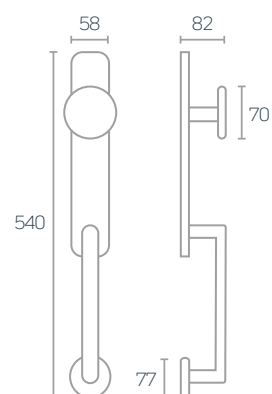

art. 8260

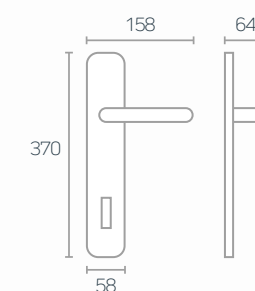

patrizio

Material: Solid Brass



art. 2833

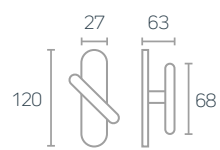

art. 2831

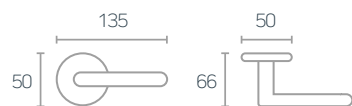

art. 2831/3421



PASINI CLASSIC

 PASINI



PASINI CLASSIC

art. 2830

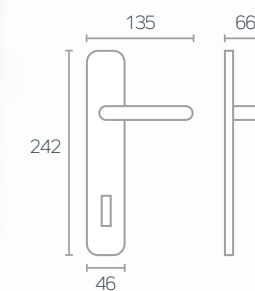

princess

Designer: Angiolino Dolcetti
Material: Solid Brass



art. 0525



art. 3781

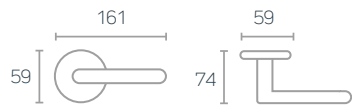

PASINI CLASSIC



PASINI CLASSIC



art. 4129

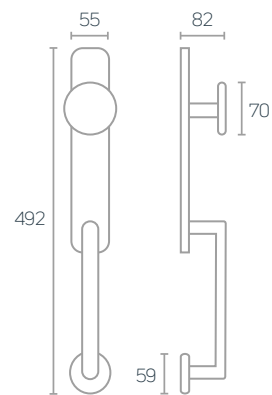

art. 3780

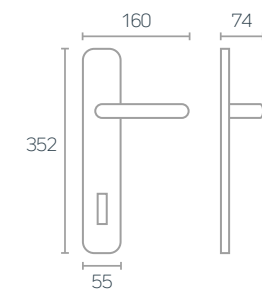

queen

Designer: Angiolino Dolcetti
Material: Solid Brass



art. 3661



art. 3661/3421



art. 3663/3421

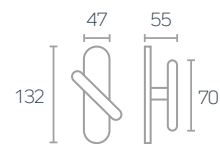

PASINI CLASSIC

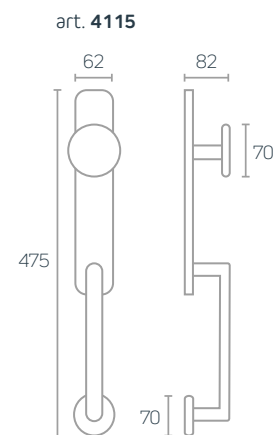

PASINI CLASSIC

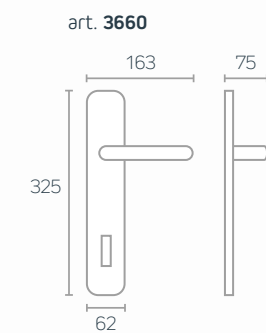

sirio

Material: Solid Brass



art. 2961



art. 2961/orig.



art. 2963

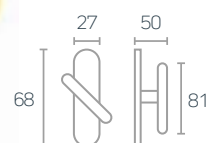

PASINI CLASSIC



PASINI CLASSIC



art. 4102

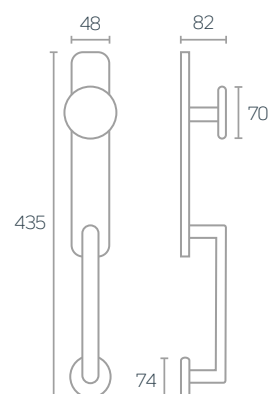

art. 2960

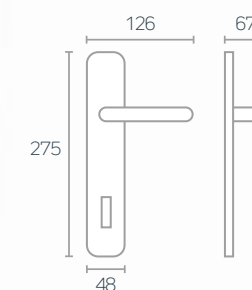

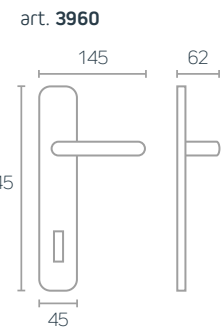
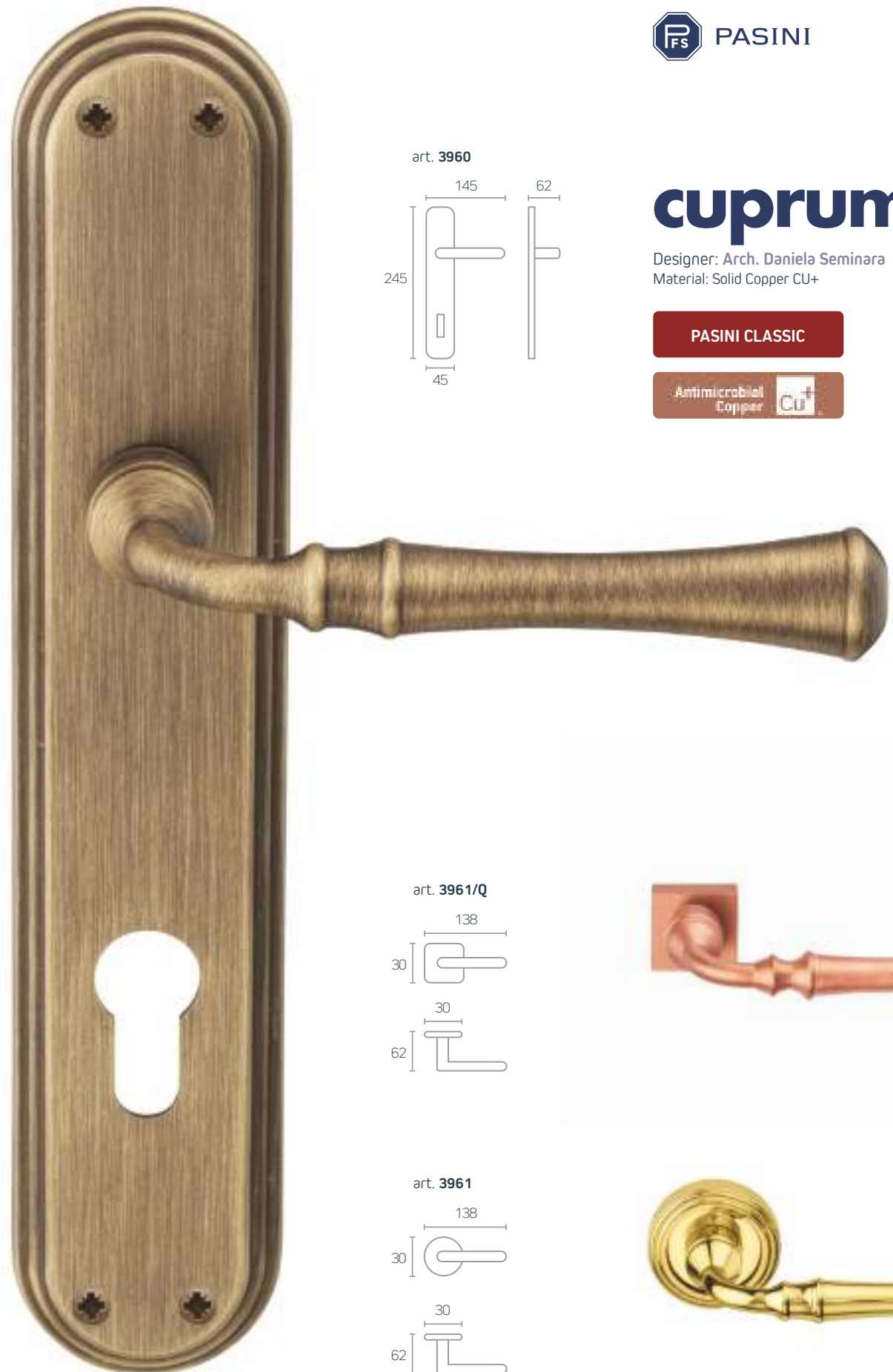

cuprum

Designer: Arch. Daniela Seminara
Material: Solid Copper CU+

PASINI CLASSIC

Antimicrobial Copper **Cu+**

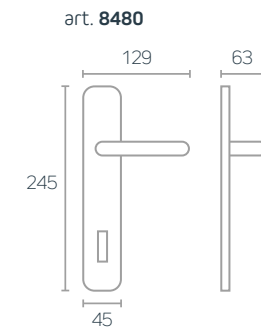
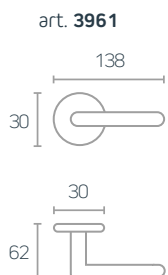
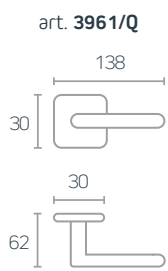

liberty

Designer: Pasini Studio
Material: Solid Brass

PASINI CLASSIC

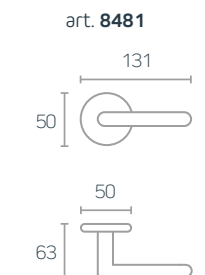
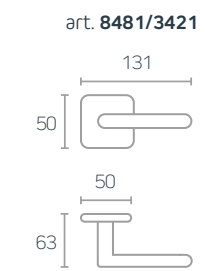

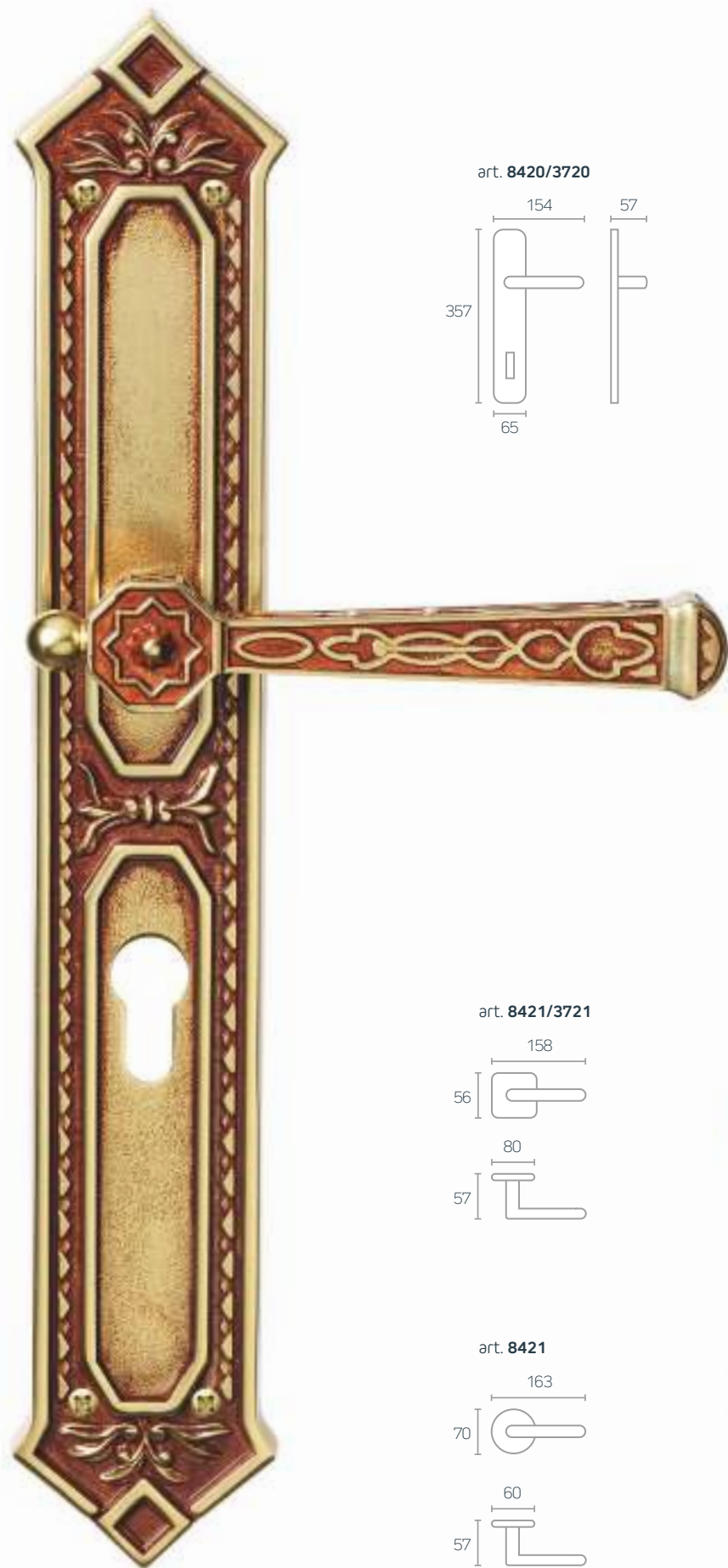

eden

Material: Solid Brass

PASINI CLASSIC

art. 8420/3720

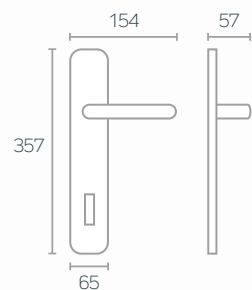

art. 8421/3721

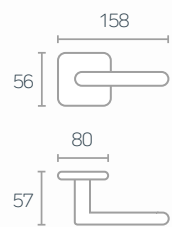

art. 8421

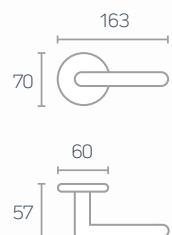

pasha

Material: Solid Brass

PASINI CLASSIC

art. 3920

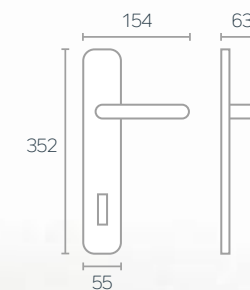

art. 3921/3421

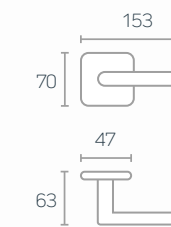

art. 3921

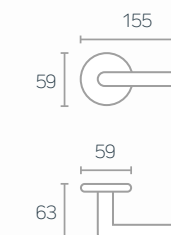

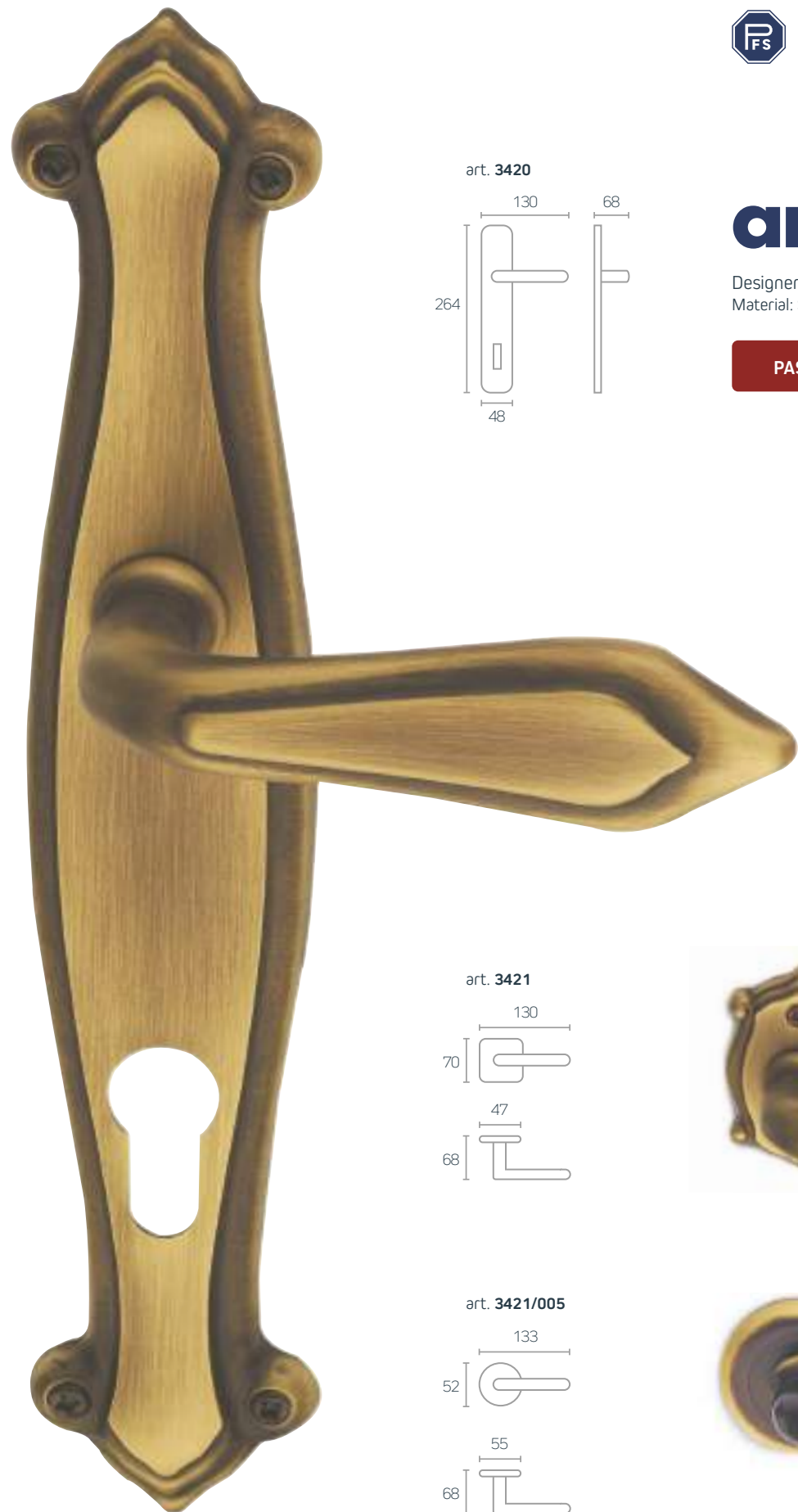

anubi

Designer: Angiolino Dolcetti
Material: Solid Brass

PASINI CLASSIC

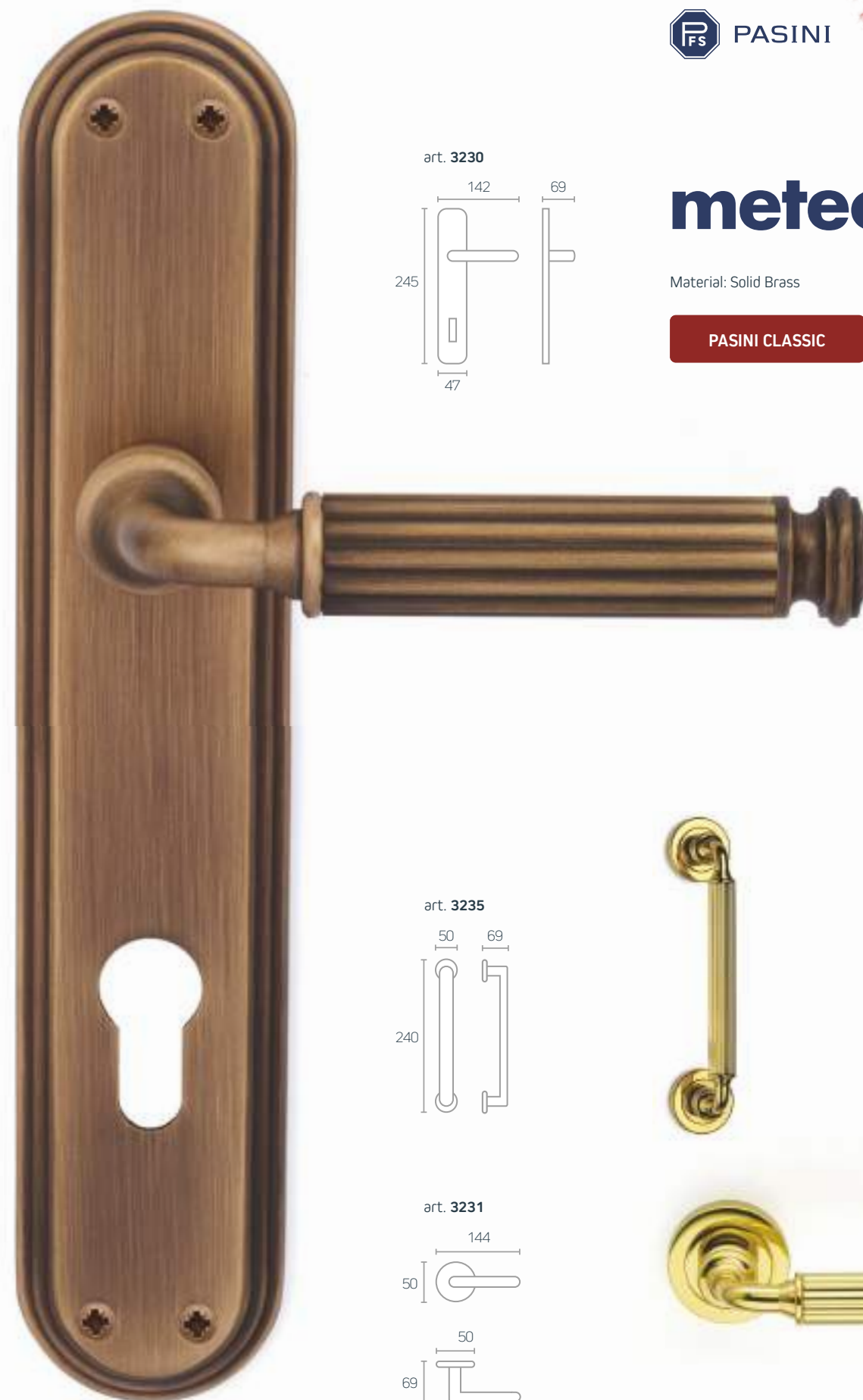
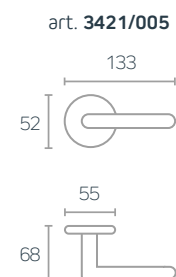
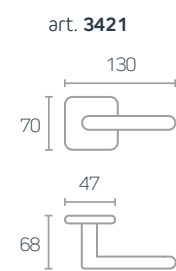
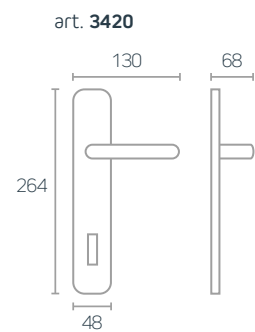

meteor

Material: Solid Brass

PASINI CLASSIC

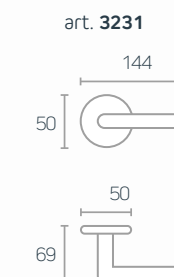
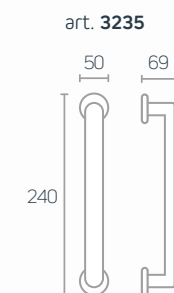
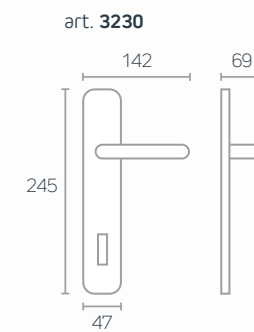

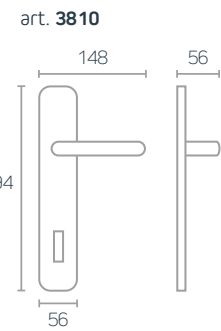
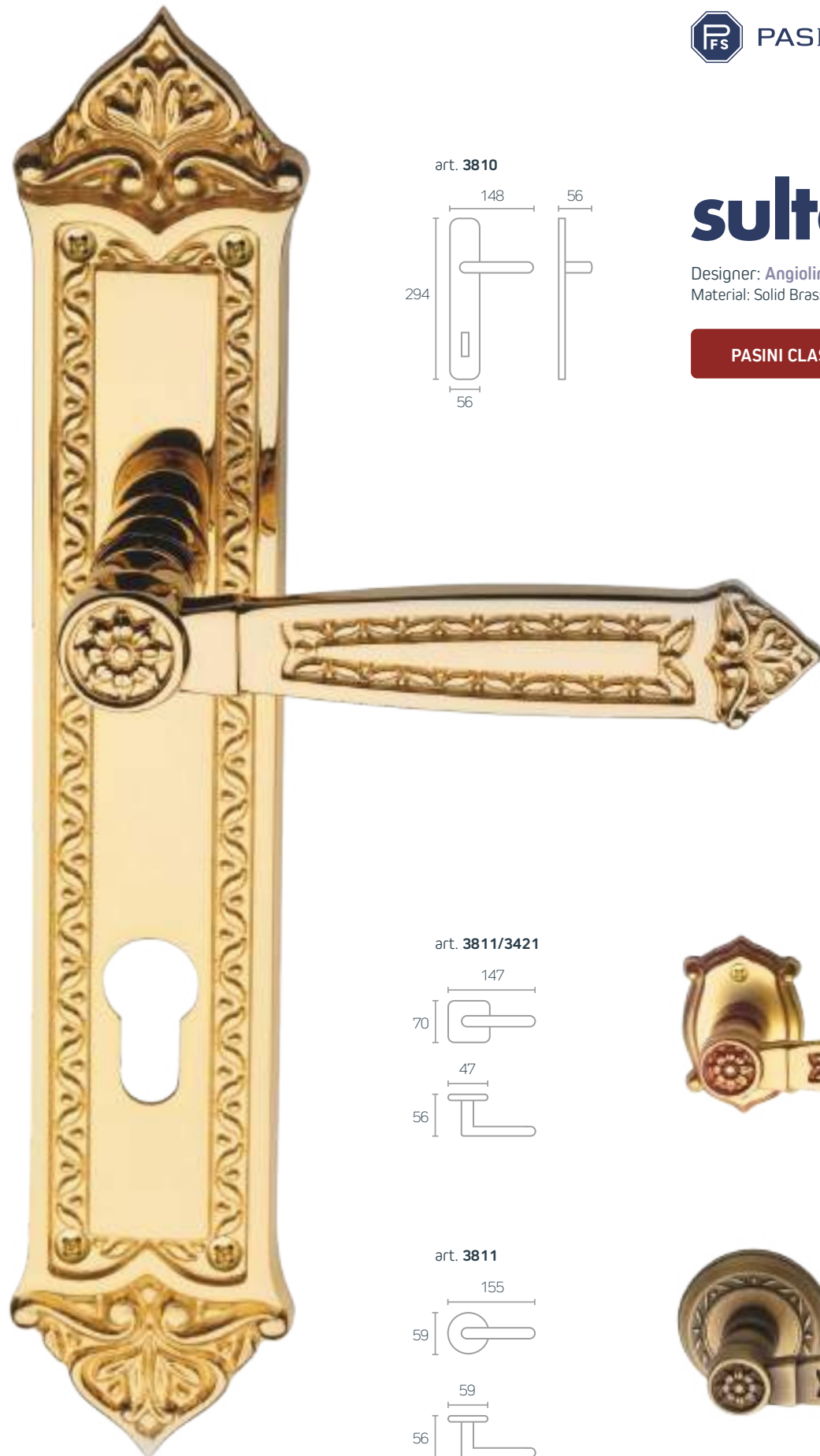

sultan

Designer: Angiolino Dolcetti
Material: Solid Brass

PASINI CLASSIC

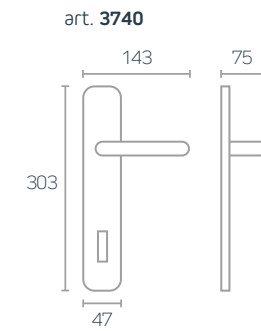
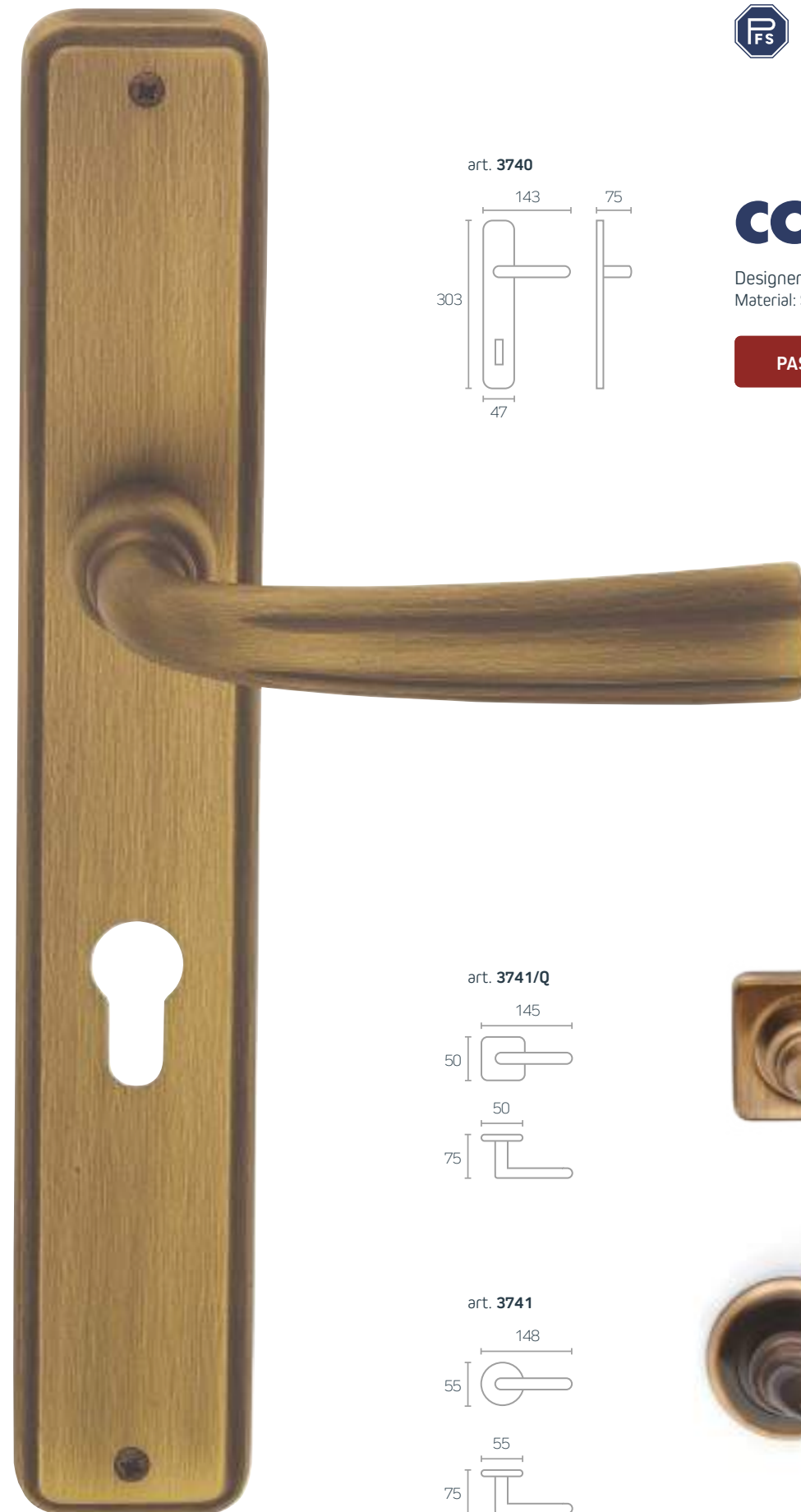
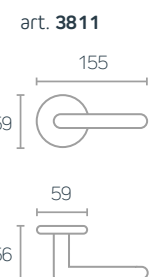
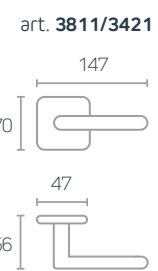

corolla

Designer: Angiolino Dolcetti
Material: Solid Brass

PASINI CLASSIC

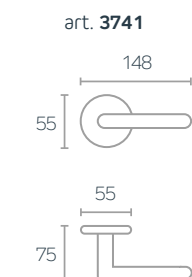
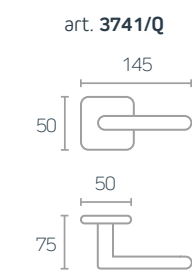

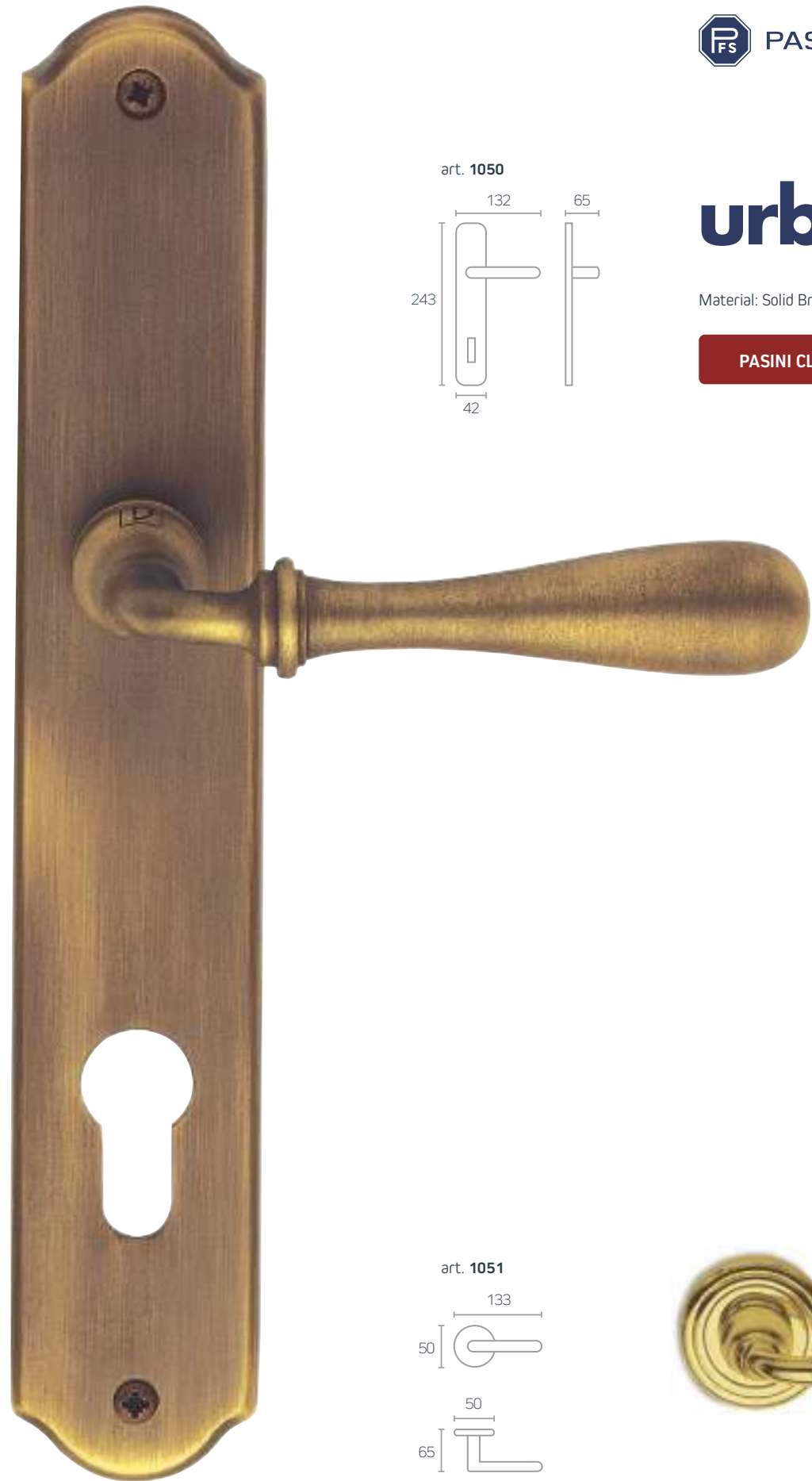

PASINI

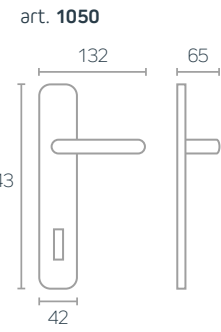

urbino

Material: Solid Brass

PASINI CLASSIC

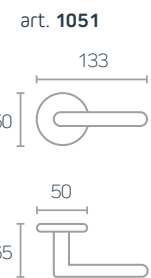

PASINI

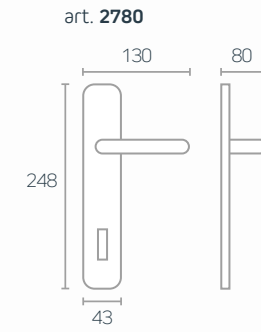

diandra

Designer: Angiolino Dolcetti
Material: Solid Brass

PASINI CLASSIC

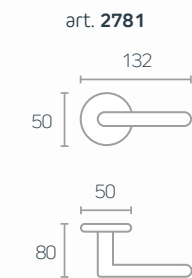
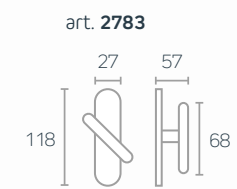

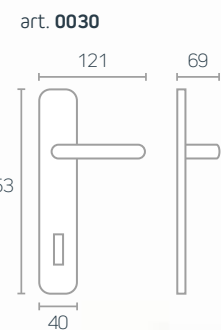

mod. 800

Material: Solid Brass

PASINI CLASSIC

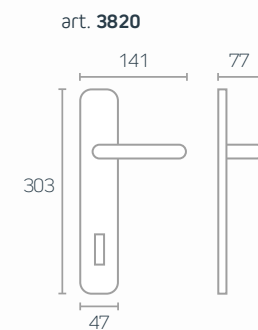
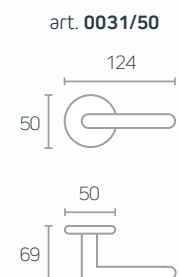
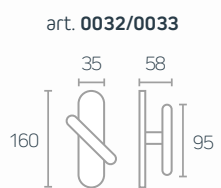

godiva

Designer: PFS Pasini Project
Material: Solid Brass - Porcelain

PASINI CLASSIC

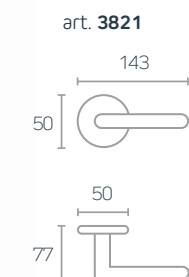

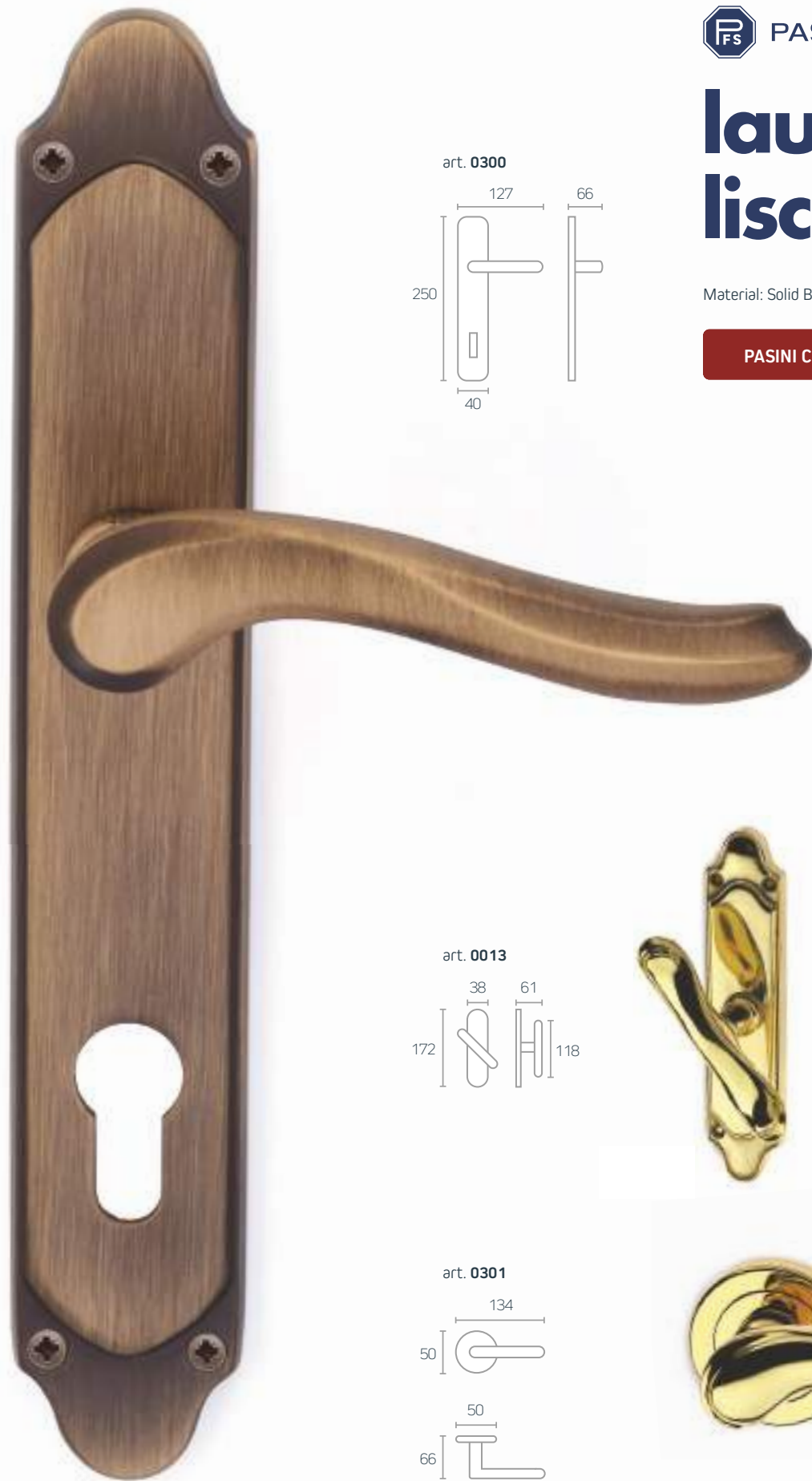

laura liscia

Material: Solid Brass

PASINI CLASSIC

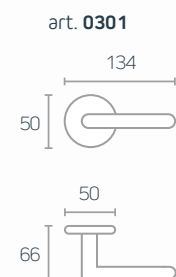
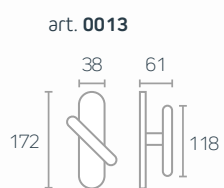
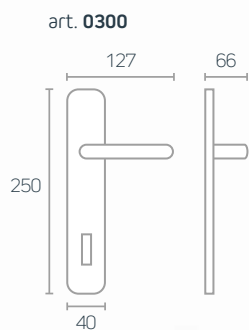

horus

Designer: Angiolino Dolcetti
Material: Solid Brass

PASINI CLASSIC

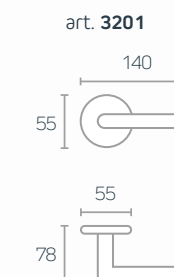
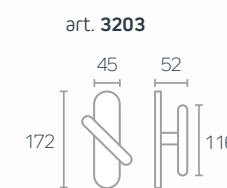
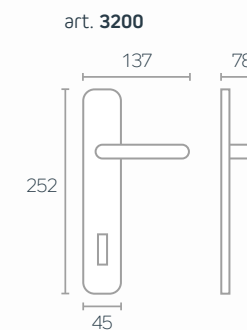

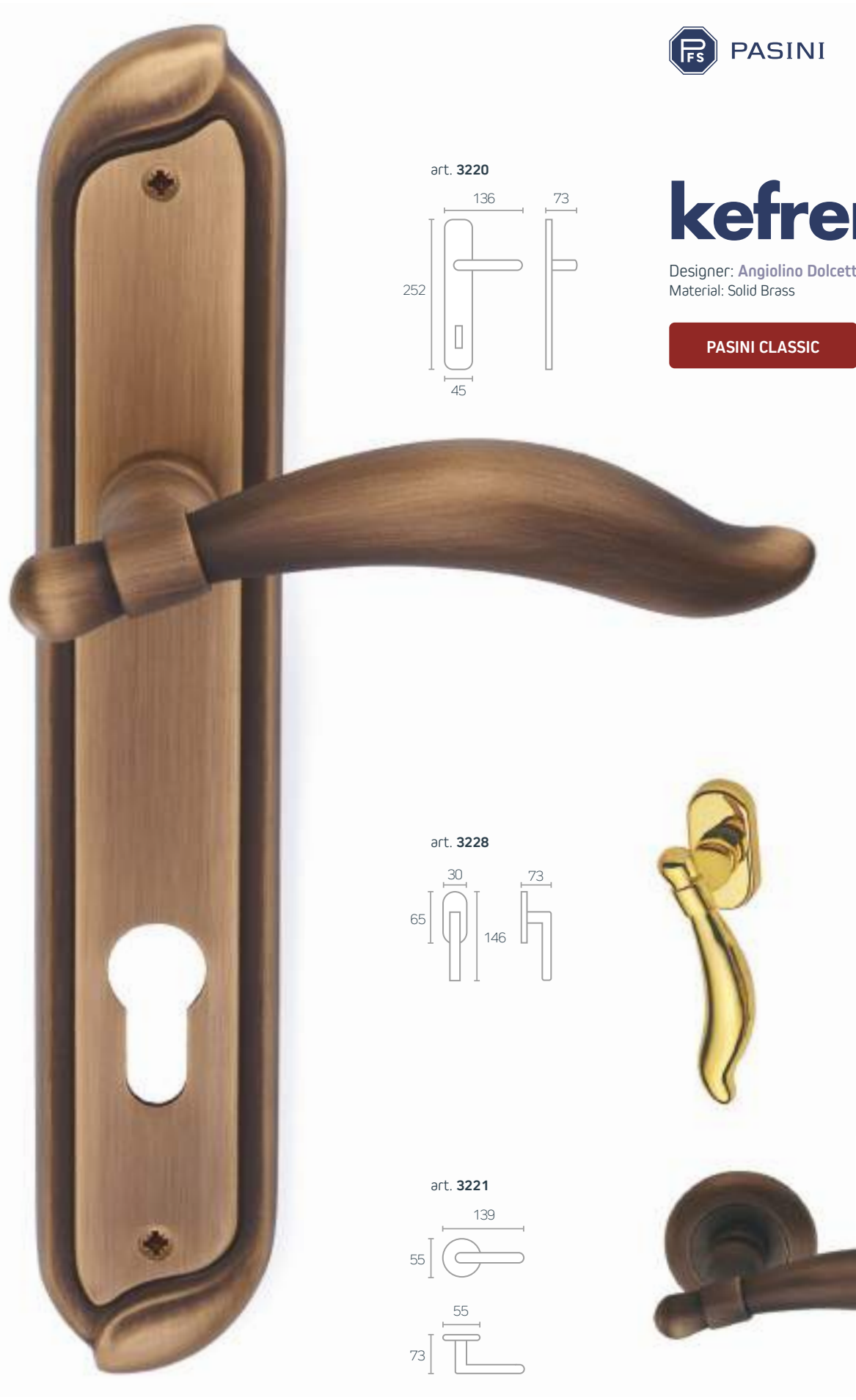

PASINI

art. 3220

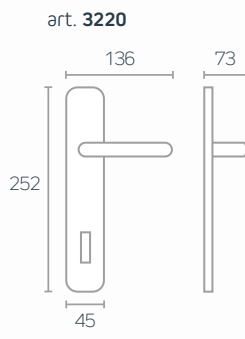

kefrem



Designer: Angiolino Dolcetti
Material: Solid Brass

PASINI CLASSIC

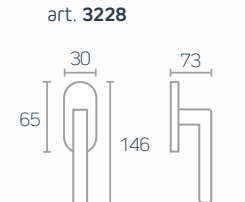
art. 3228

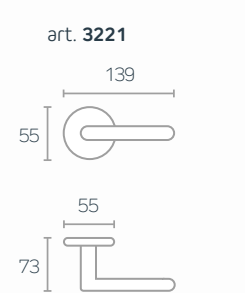

art. 3221

PASINI

art. 1440



colonia

Material: Solid Brass

PASINI CLASSIC

art. 1441





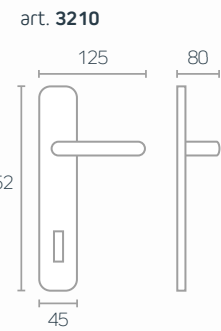
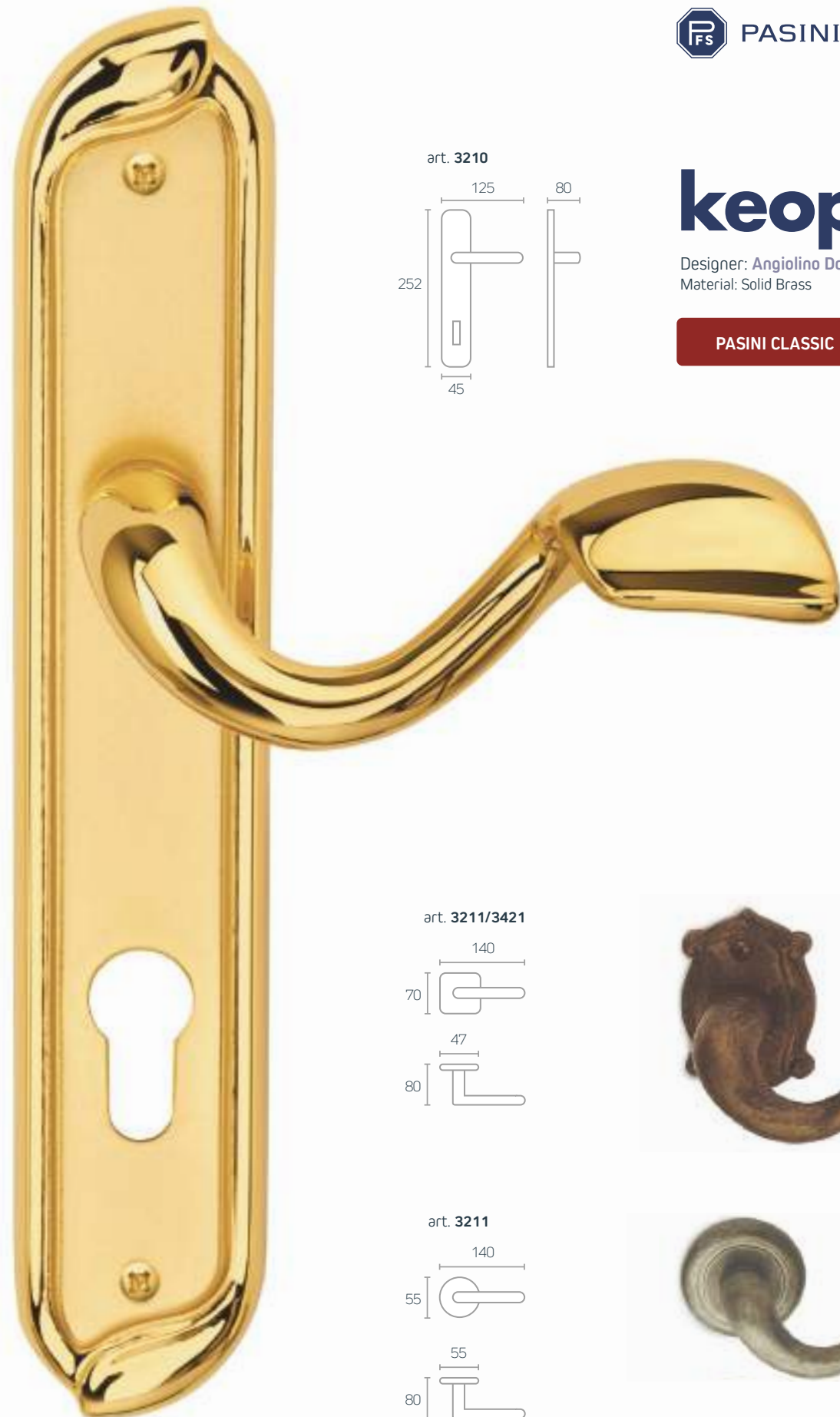

keope

Designer: Angiolino Dolcetti
Material: Solid Brass

PASINI CLASSIC

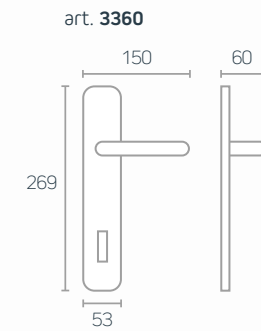
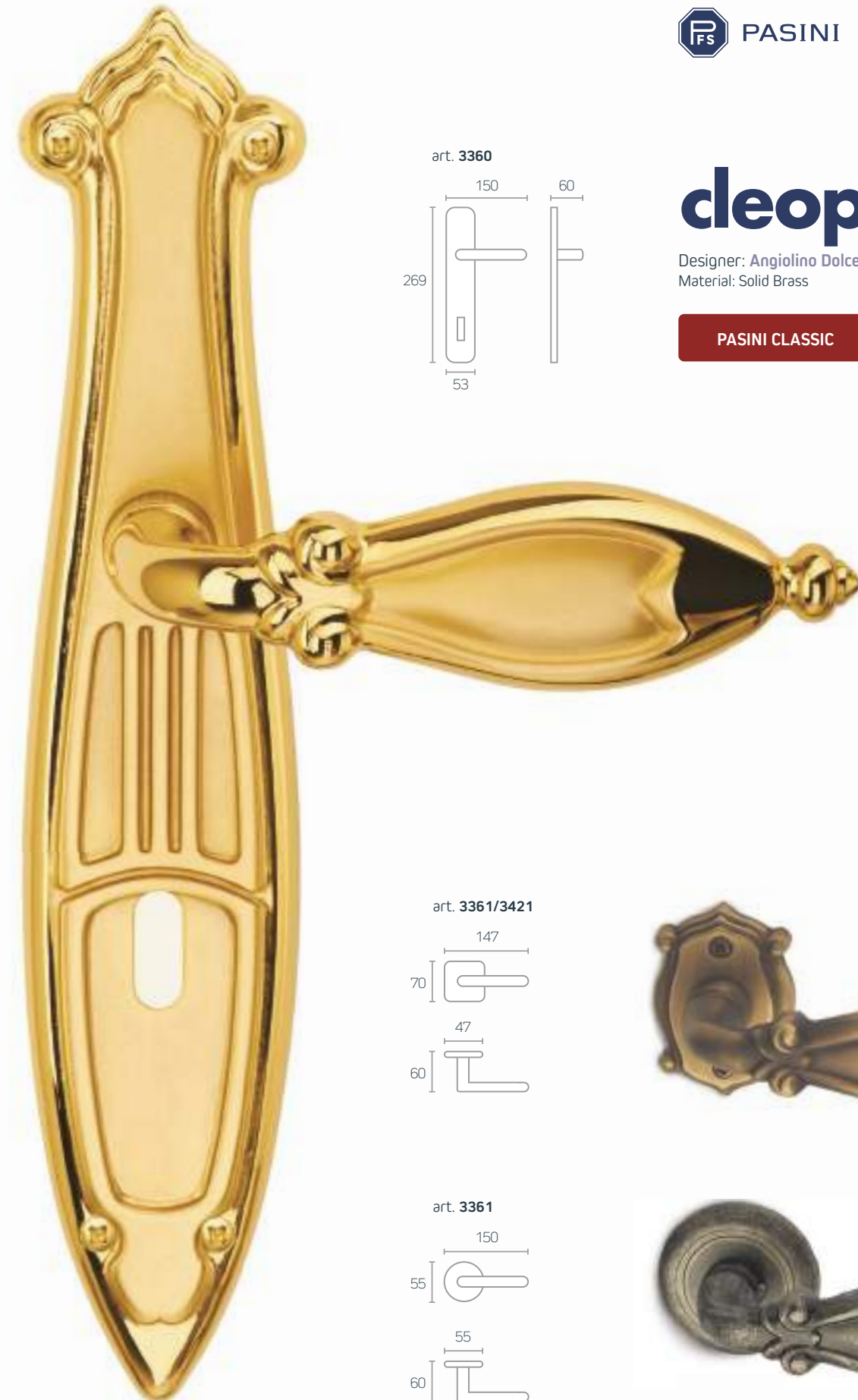
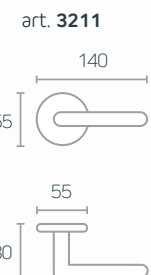
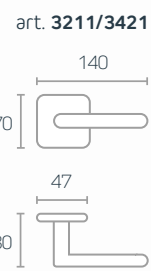

cleopatra

Designer: Angiolino Dolcetti
Material: Solid Brass

PASINI CLASSIC

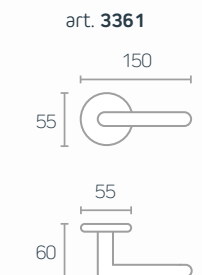
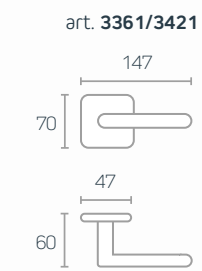

Pasini Design
La seduzione tra
tradizione e
modernità.

Pasini Design
The seduction between
tradition and
innovation.

Pasini Design

La seduzione è un'arte e le nostre maniglie della linea Pasini Design sono perfettamente in grado di colpire nel segno: lo stile e le linee raffinate di questa collezione stimolano ogni tuo desiderio più recondito, lo portano alla luce e ti permettono di toccarlo con mano. Attraverso un sapiente utilizzo di materiali diversi, queste maniglie affascinano e incantano: se la semplice vista ti tenta, il tatto ti ammalia completamente.

The seduction is an art and the handles of our Pasini Design line hit the highest point: the style and the elegant lines of this collection excite your secret dreams and allow you to see them with your own eyes. With a wise use of different materials, these handles charm and seduce you: if the only sight tempt you, the touch totally charm you.



Filo! DK e Filo! BK
sono un nuovo modo di
vedere ed utilizzare la
maniglia per finestra.

Rosetta Filo!

Questi due sistemi brevettati sono delle soluzioni tecnologiche ed innovative per il Dreh Kipp. Il nuovo design FILO riduce a soli 6mm lo spessore della rosetta, sia ovale che rettangolare ed è così in grado di donare alla maniglia un design moderno, accattivante e molto elegante. Il nuovo Sistema FILO! BK oltre ad avere la rosetta FILO, è dotato di un sistema di bloccaggio sempre in funzione. Questa rosetta brevettata, ha al suo interno un meccanismo di blocco automatico in ogni posizione, quando la finestra è chiusa o aperta, l'unico modo per sbloccarla è attraverso una levetta posizionata in basso. Si può sbloccare la maniglia solo utilizzando due mani, grazie a questo meccanismo, la maniglia è sempre bloccata, ed è inoltre una sicurezza in più per i piccoli di casa. Il sistema FILO!BK migliora la sicurezza delle tue finestre.

Realizzata da PFS Pasini, FILO!50 è un nuovo sistema brevettato di fissaggio per rosette, disponibile in disegno ovale e quadrato. FILO!50 è un sistema tecnologico e innovativo di fissaggio alla porta, completo di molla che riduce a soli 5 mm. lo spessore della rosetta e bocchetta. Tecnologia, design, funzionalità e innovazione nei soli 5mm. di FILO!50. Grazie al brevetto FILO!50 non saranno più necessari fori su misura per l'installazione della molla.



Window handle DK Filo!

These two patented systems are an innovative and technological window handles fixing system. Their new technical design consent to reduce to only 6 mm the thickness of the oval or rectangular rosette giving your window handle a modern, slim and elegant design. The new system Filo! BK furthermore, is equipped with a block mechanism that is always activated. This patented system has a self block that works in every position, when the window is closed or open you can only unlock it thorough the lever. To unlock the window handle you always have to use two hands, in this way you are sure that the window is always blocked and it is an additional child safety system. The FILO! BK system improves the security of your windows.

Filo! Rose

Designed by PFS Pasini, FILO!50 is a new patented fixing system for roses, available in round or square design. FILO!50 is a technological and innovative door fixing system, complete with a spring that reduces to 5mm. the thickness of the rose and escutcheon. Technology, design, functionally and innovation in just 5mm. of FILO!50. Thanks to FILO!50 there is no need of further drilling or milling on the door.

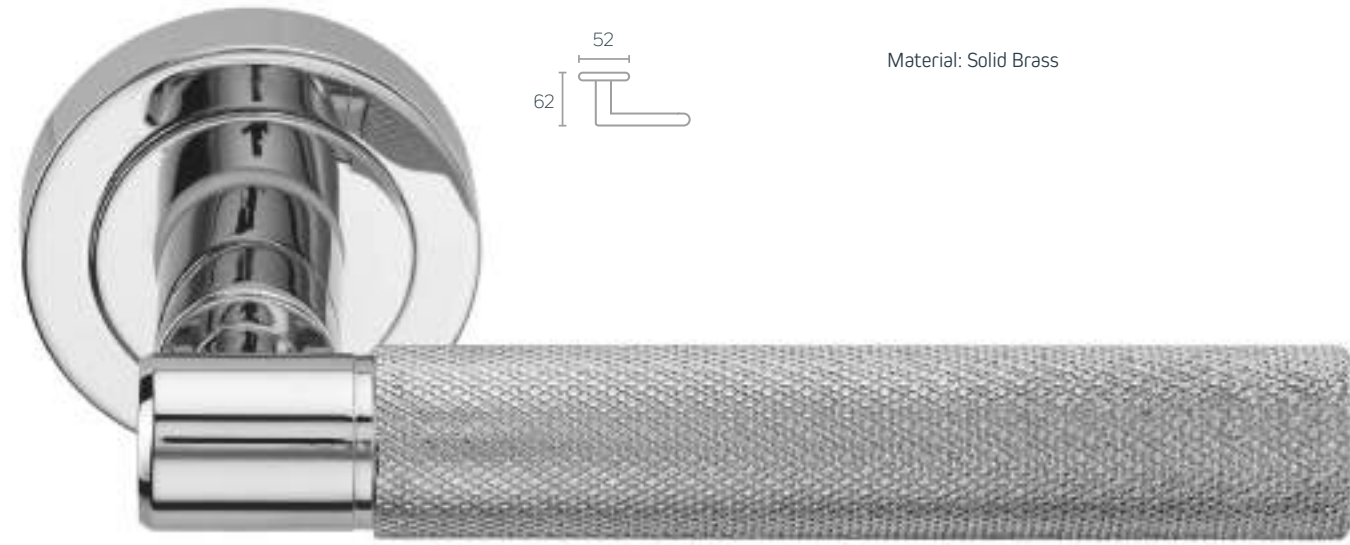

art. 7221

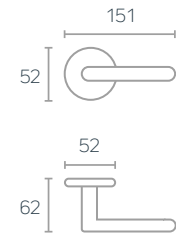

techno

Material: Solid Brass



PASINI DESIGN

7221 TECHNO GRIP

art. 7211

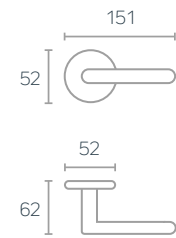

7211 TECHNO LINE

art. 7221

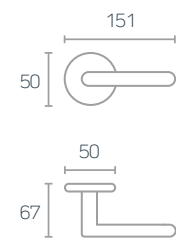

7221 TECHNO GRIP



art. 7200

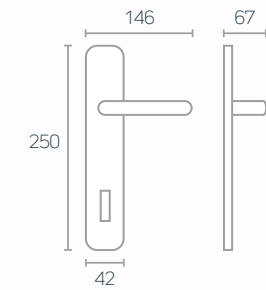

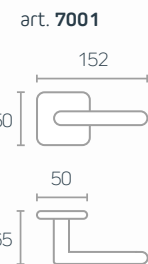
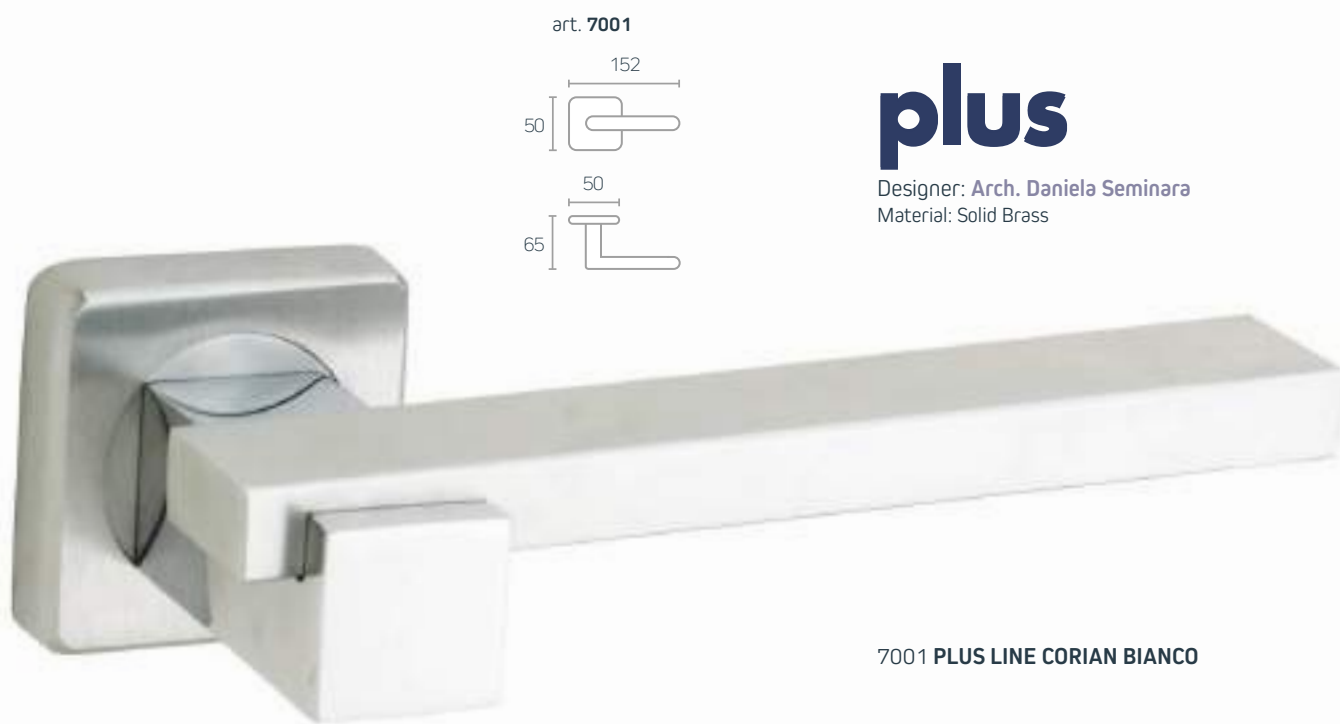

plus

Designer: Arch. Daniela Seminara
Material: Solid Brass

7001 PLUS LINE CORIAN BIANCO



PASINI DESIGN

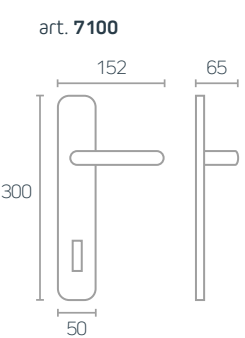
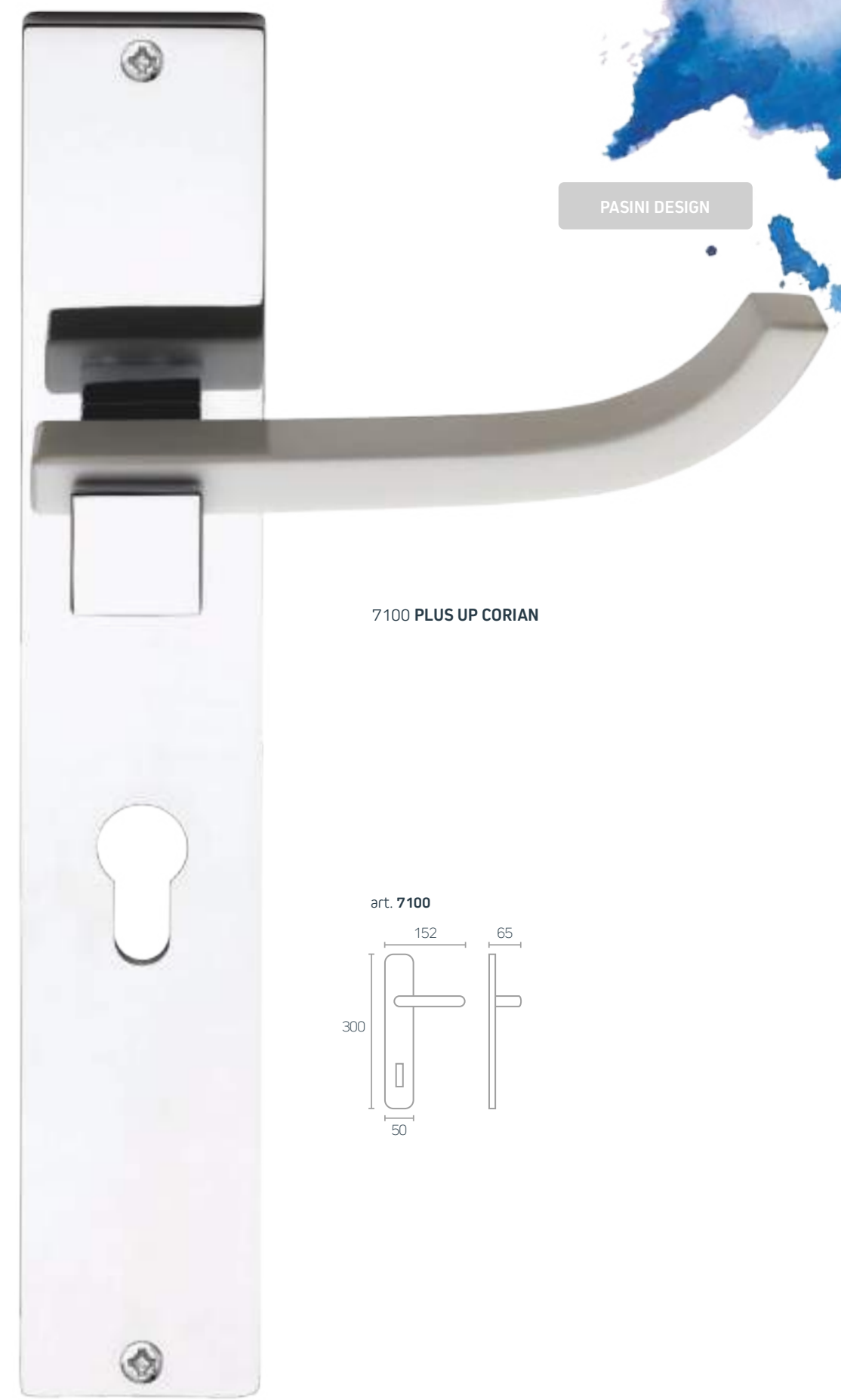

7100 PLUS UP CORIAN

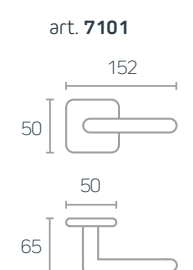

7101 PLUS UP

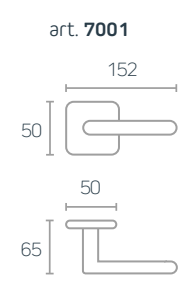

7101 PLUS LINE



art. 4126

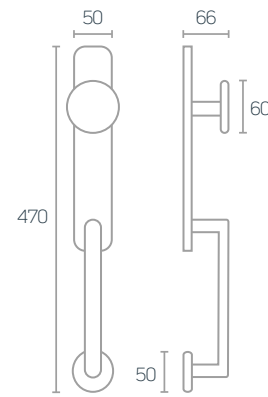

quadrata

Designer: Angiolino Dolcetti
Material: Solid Brass



PASINI DESIGN

art. 3673

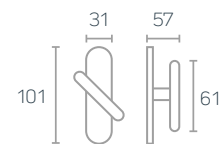

art. 3541/0001

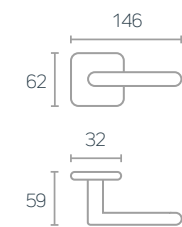

art. 3541

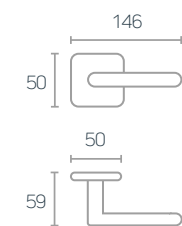

art. 3540

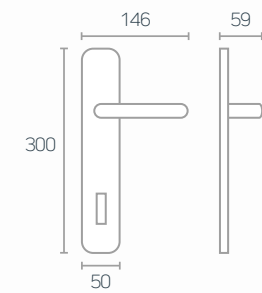

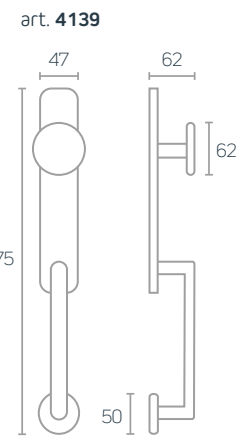

duke

Designer: Angiolino Dolcetti
Material: Solid Brass



PASINI DESIGN

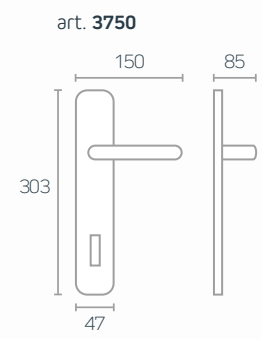
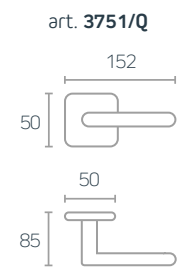
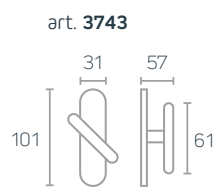

art. 8341/IDQ

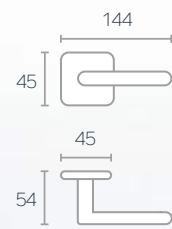

arrow

Material: Solid Brass

PASINI DESIGN



art. 8341/ID

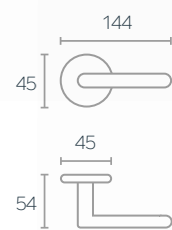

art. 8341

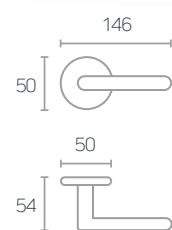

art. 8331/IDQ



twist

Material: Solid Brass

PASINI DESIGN



art. 8331/IDQ

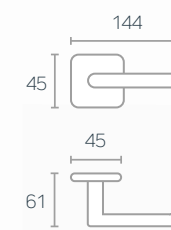

art. 8331/50

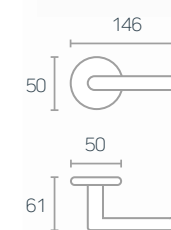

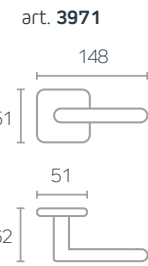

prima

Designer: Arch. Daniela Seminara
Material: Solid Copper CU+

PASINI DESIGN

Antimicrobial Copper **Cu+**

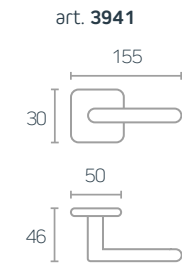
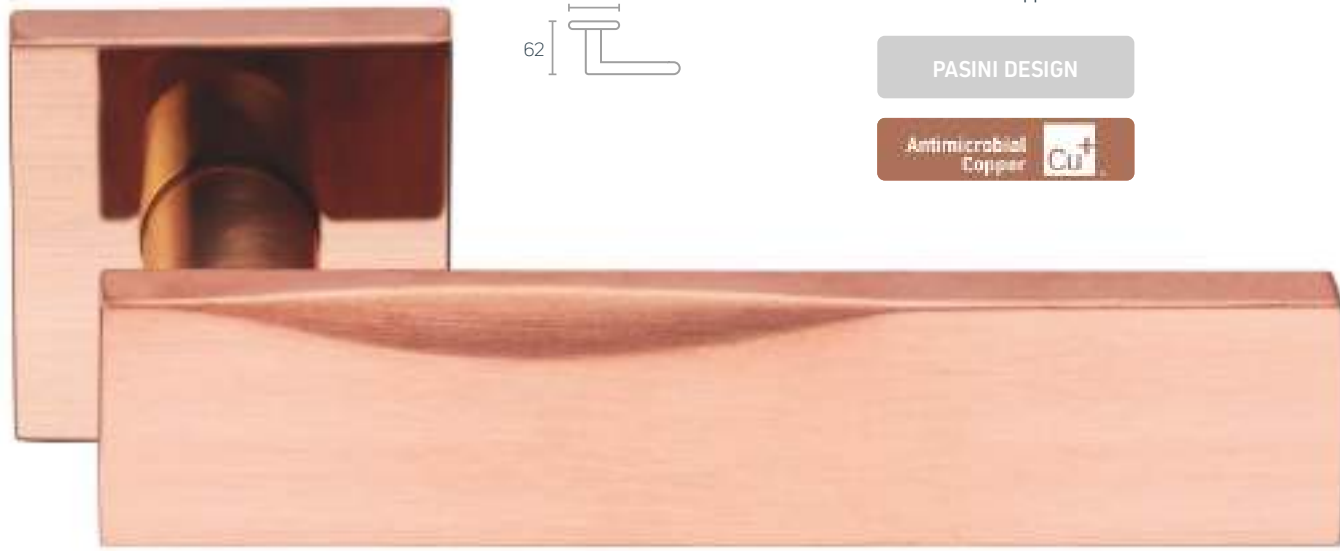

tratto

Material: Solid Brass

PASINI DESIGN

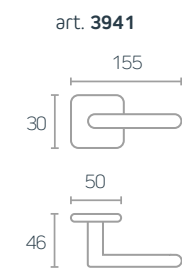
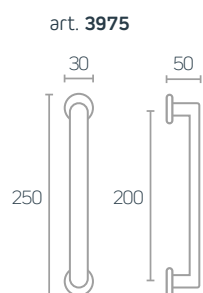
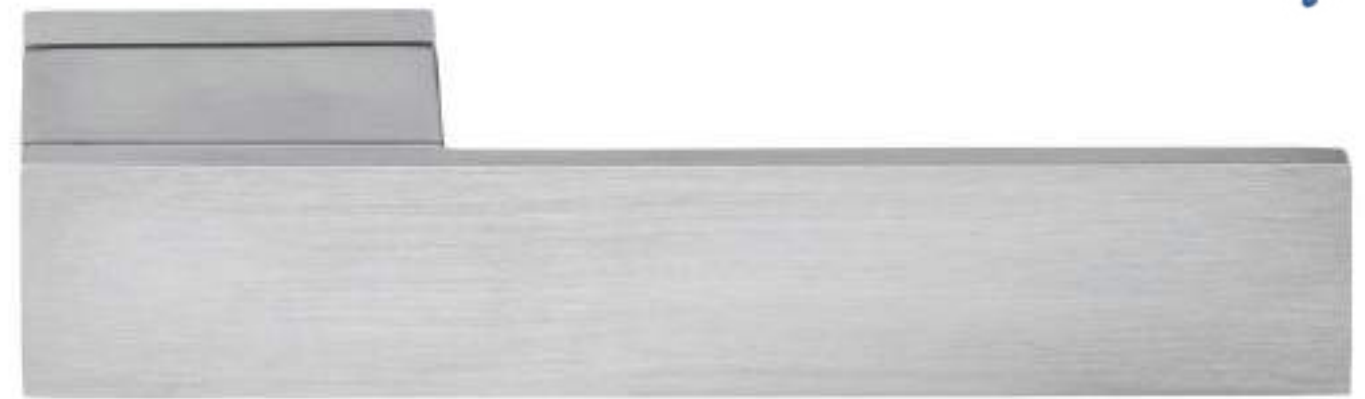

art. **MP2027**

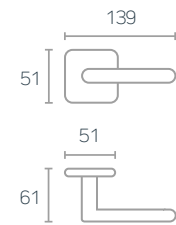

pesaro

Material: Solid Brass

PASINI DESIGN



art. **MP2018**

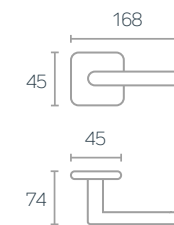

milano

Material: Solid Brass

PASINI DESIGN



art. **MP2027/3540**

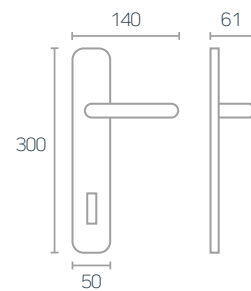

art. **MP2027/UP**

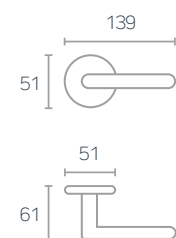

art. **MP2018**

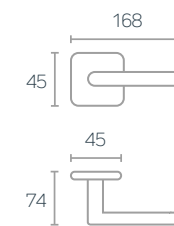

art. **MP2018**

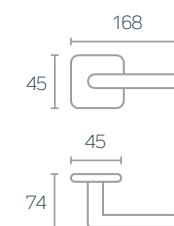



art. MP2026

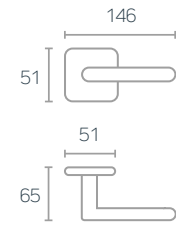

torino

Material: Zinc Alloy

PASINI DESIGN



art. MP2028

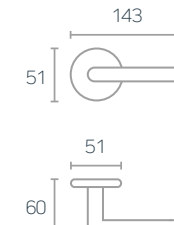

udine

Material: Zinc Alloy

PASINI DESIGN



art. MP2026

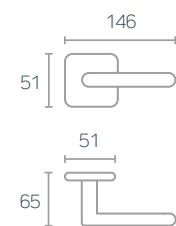

art. MP2028

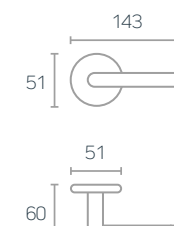



art. MP2029

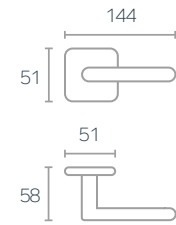

sorrento

Material: Zinc Alloy

PASINI DESIGN



art. MP2024

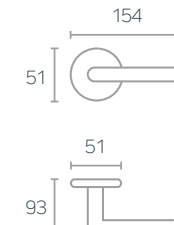

imperia

Material: Zinc Alloy

PASINI DESIGN



art. MP2029

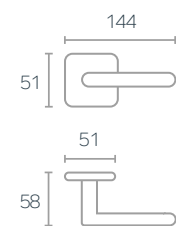

art. MP2024/Q

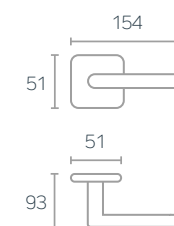

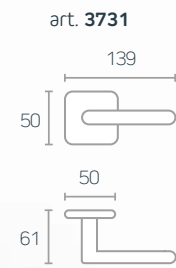

trend

Material: Solid Brass

PASINI DESIGN

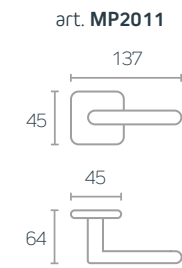
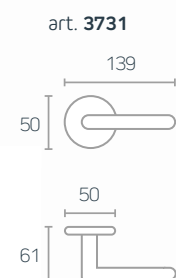
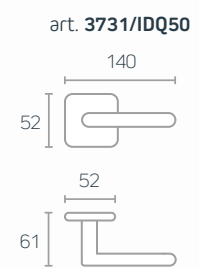

cervinia

Material: Solid Brass

PASINI DESIGN

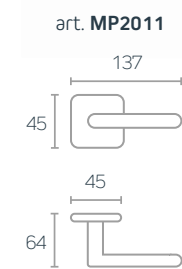
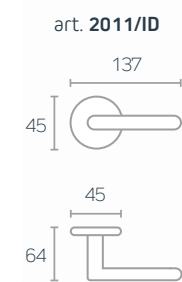

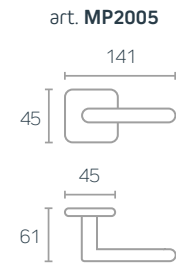

barletta

Material: Solid Brass

PASINI DESIGN

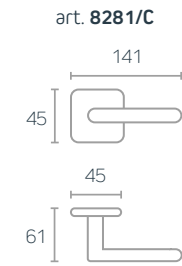
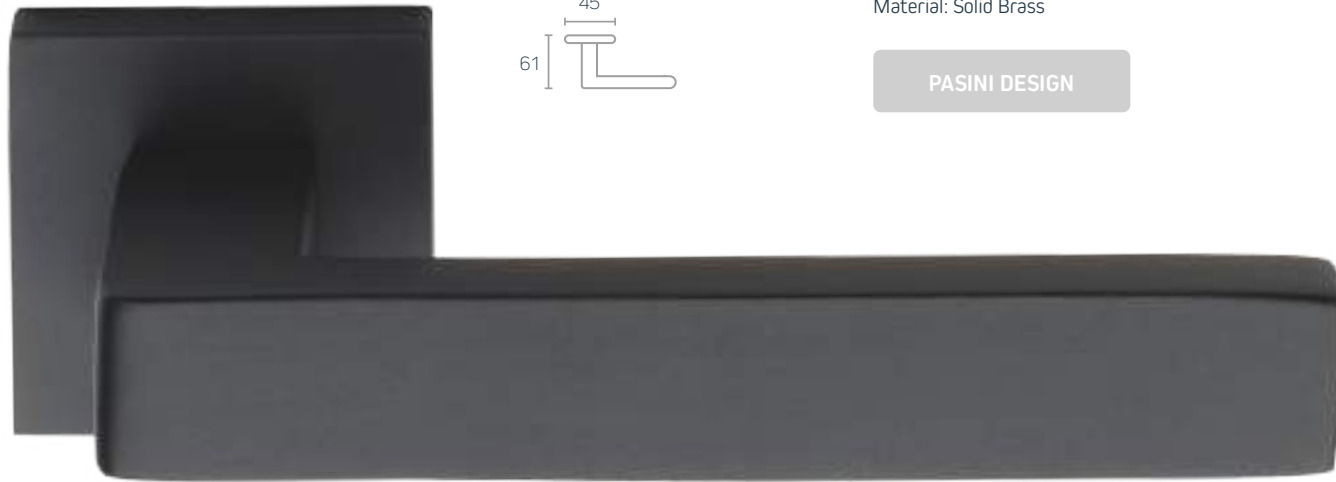

barletta cristal

Material: Solid Brass

PASINI DESIGN

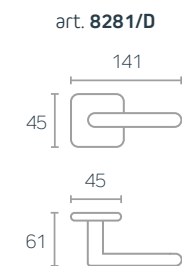
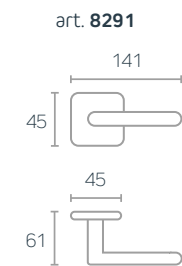
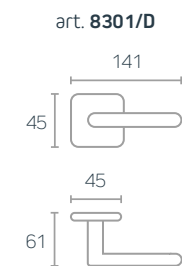
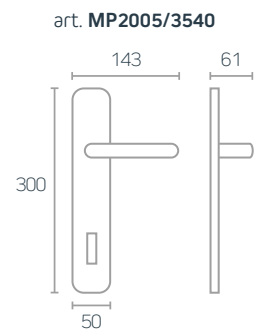
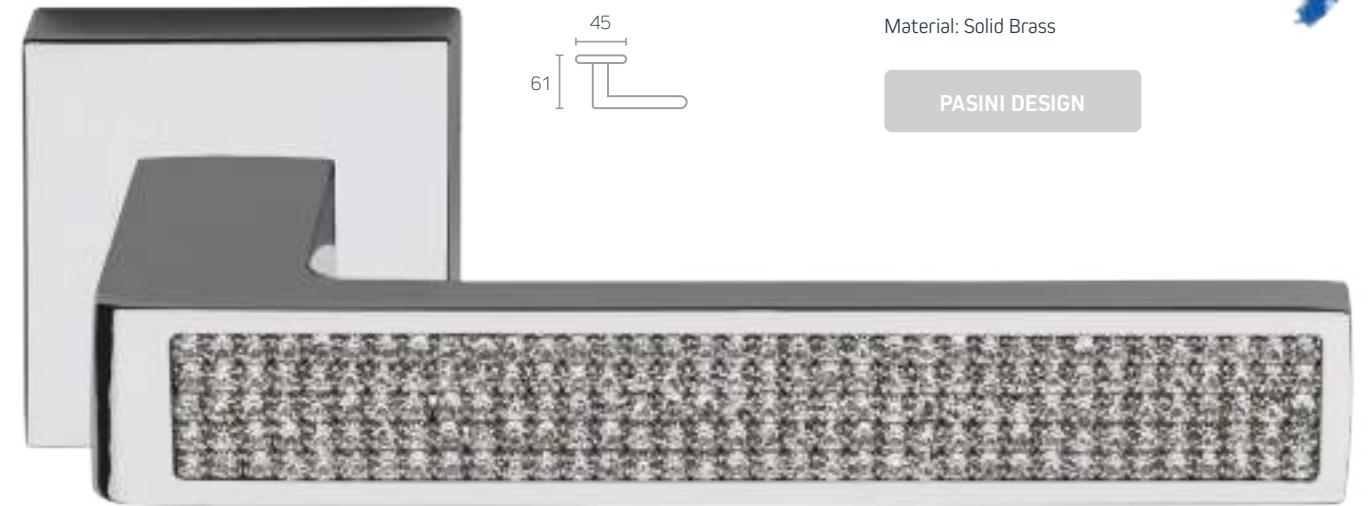

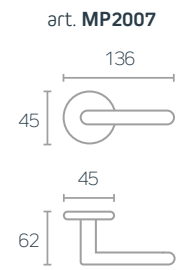

pompei

Material: Solid Brass

PASINI DESIGN

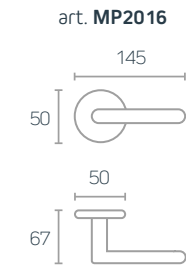
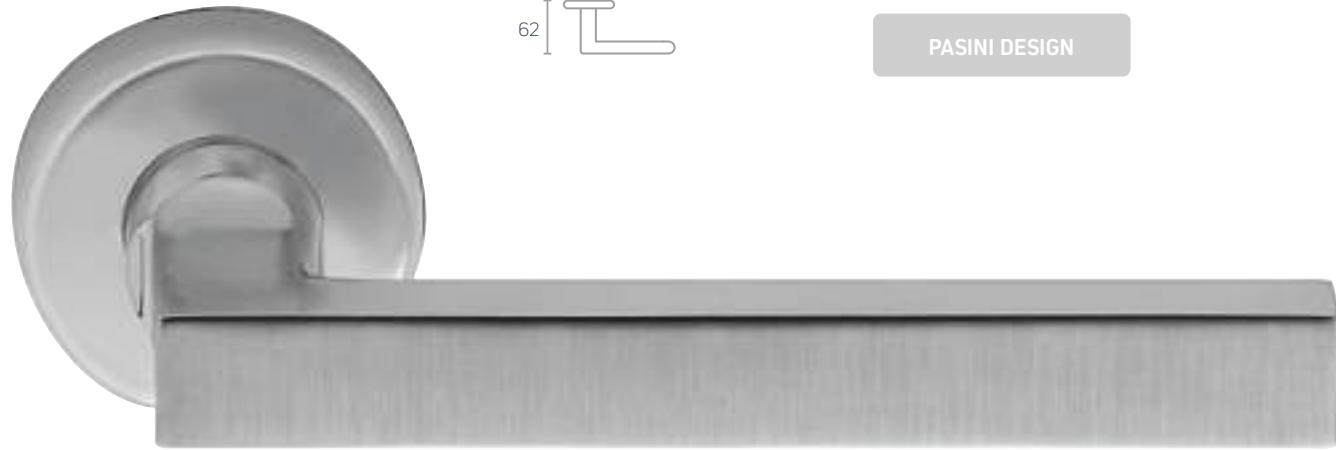

portofino

Material: Solid Brass

PASINI DESIGN

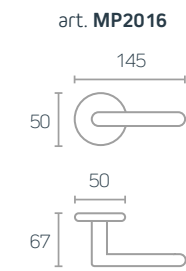
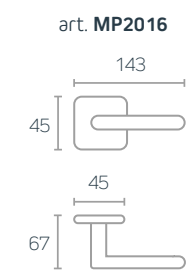
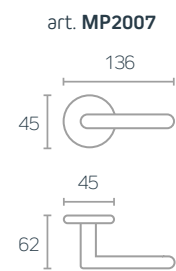
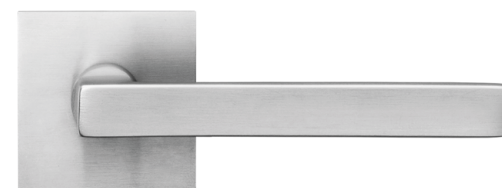
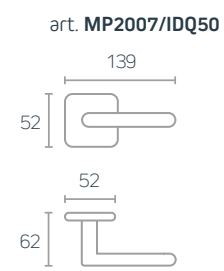
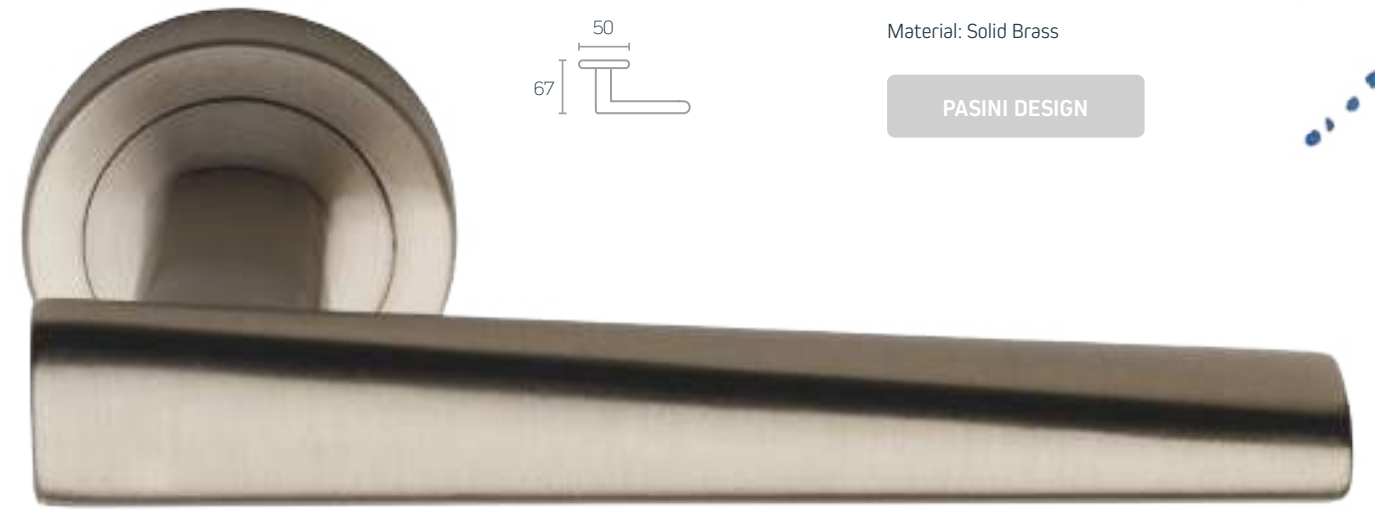



art. **MP2012**

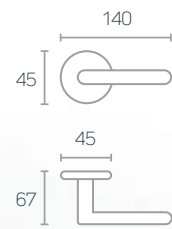

siena

Material: Solid Brass

PASINI DESIGN



art. **3481**



katana

Material: Solid Brass

PASINI DESIGN



art. **MP2012/Q**

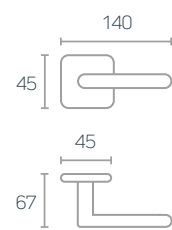

art. **3480**

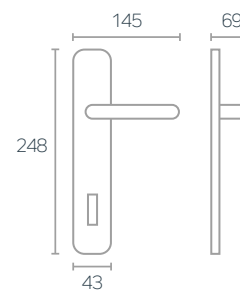

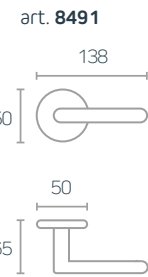

idro

Material: Solid Brass

PASINI DESIGN

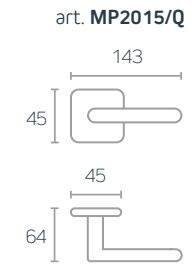
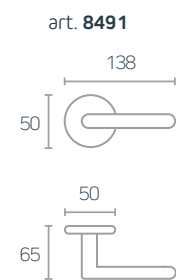
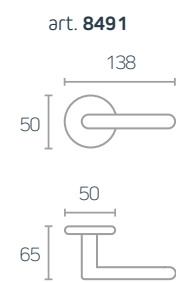

asolo

Material: Solid Brass

PASINI DESIGN

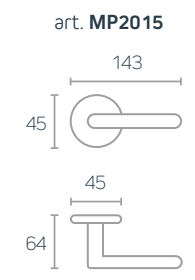



art. MP2003

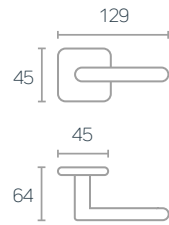

bellagio

Material: Solid Brass

PASINI DESIGN



art. MP2002

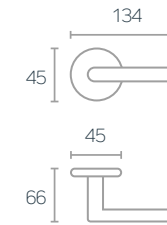

cernobbio

Material: Solid Brass

PASINI DESIGN



art. MP2003

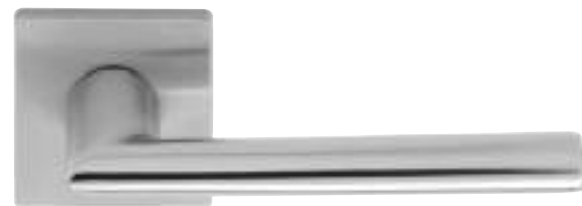
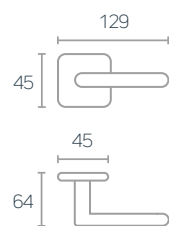

art. MP2002

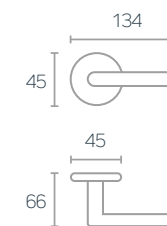

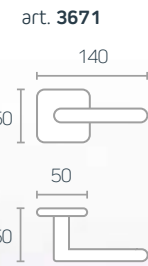

bermuda

Designer: PFS Original Project
Material: Solid Brass

PASINI DESIGN

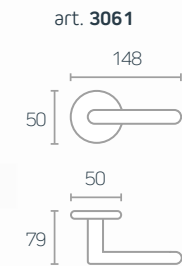

calypso

Designer: Angiolino Dolcetti
Material: Solid Brass

PASINI DESIGN

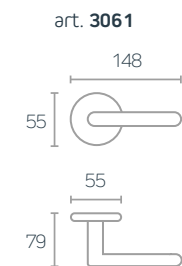
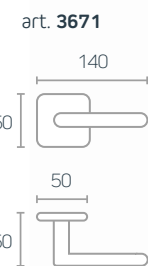
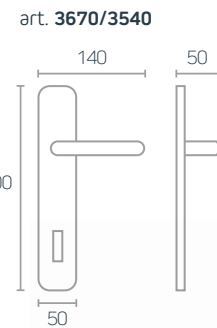

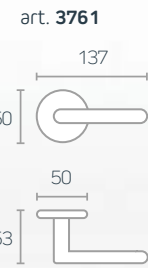

expo

Designer: PFS Original Project
Material: Solid Brass

PASINI DESIGN

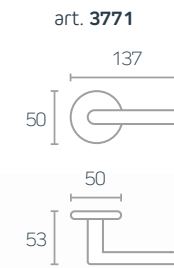
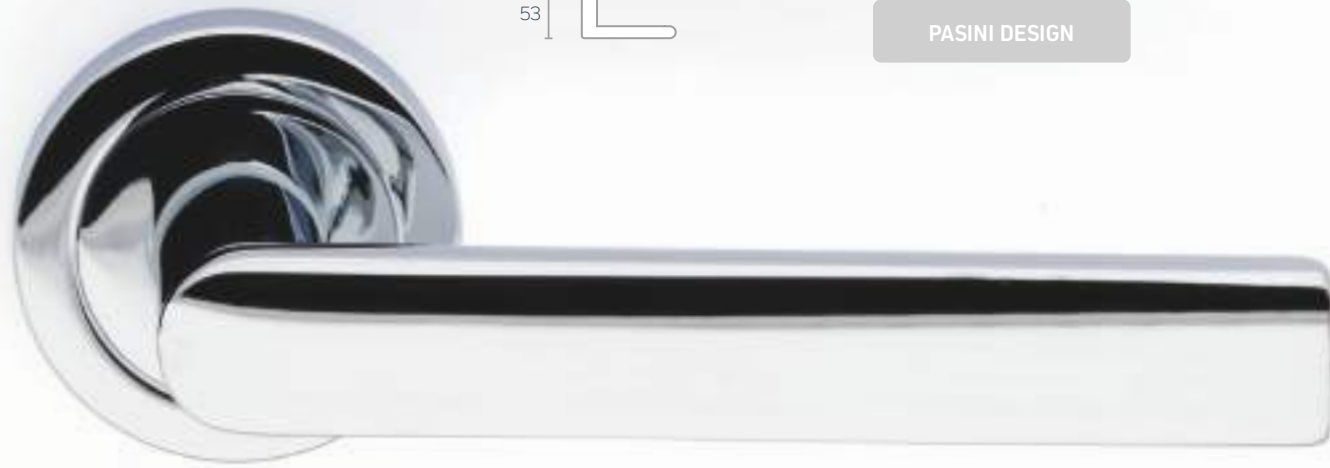

expo2

Designer: PFS Original Project
Material: Solid Brass

PASINI DESIGN

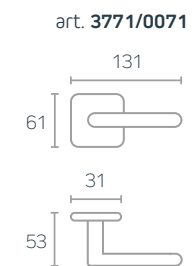
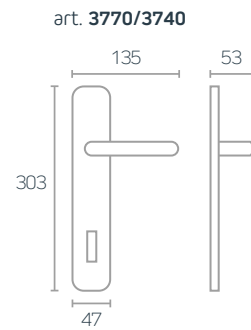
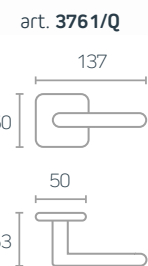
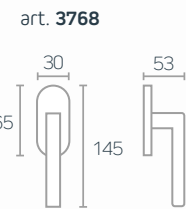

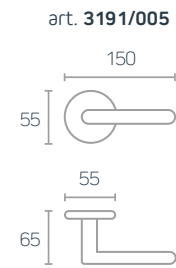

electra

Material: Solid Brass

PASINI DESIGN

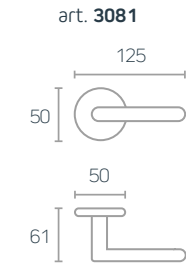
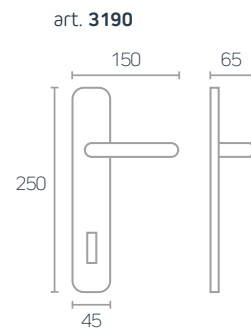
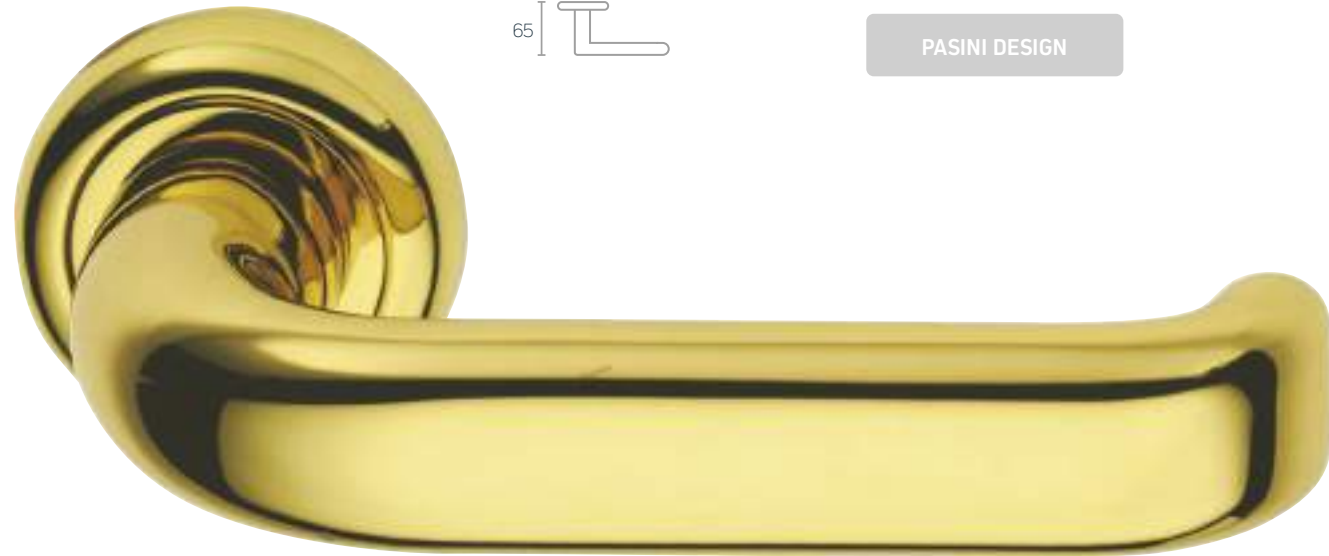

mistral

Material: Solid Brass

PASINI DESIGN

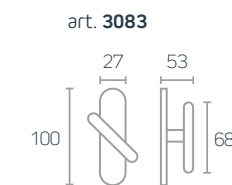
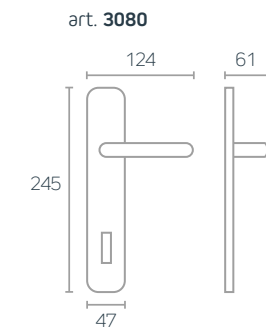

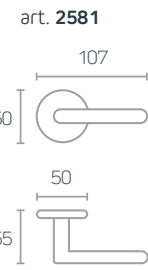

royal

Material: Solid Brass

PASINI DESIGN

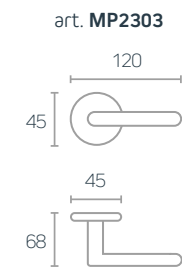

amalfi

Material: Solid Brass

PASINI DESIGN

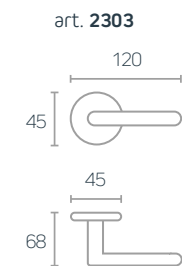
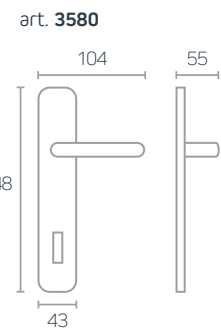

Pasini Essential
La semplicità della
carezza quotidiana.

Pasini Essential
The comfort of
your daily smile.

Pasini Essential

Hai un animo concreto, che ricerca la più pura semplicità delle cose. L'essenzialità è necessaria per tenerti con i piedi ben saldi a terra e sentirti soddisfatto. La linea Pasini Essential ti cattura per la sua naturalezza delle linee, ti affascina per la sua intelligente scelta dei materiali, per diventare parte insostituibile della tua quotidianità.

You have a skilled and concrete soul who search the pure reality of the things. The essentiality of our door hardware makes you feel more practical and satisfied. The Pasini Essential line catches you for its fluid lines, charms you for its smart choice of the materials and became an irreplaceable part of your everyday life.

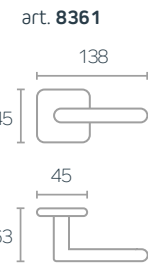

ale

Material: Zamak

PASINI ESSENTIAL

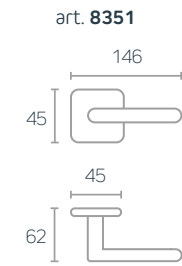

vale

Material: Zamak

PASINI ESSENTIAL

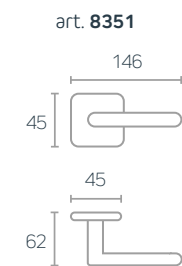
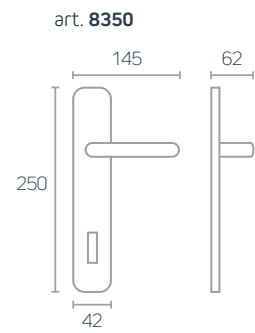
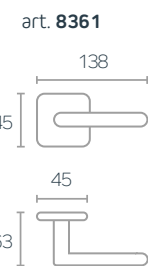
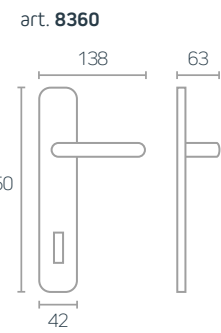
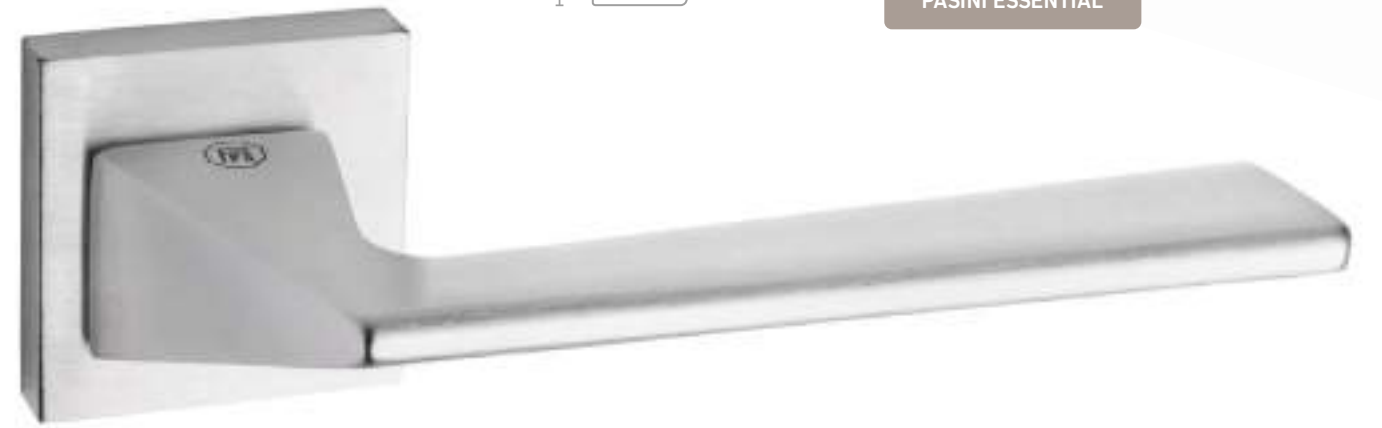

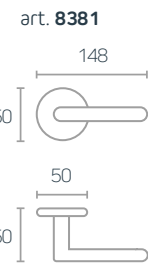

roby

Material: Zamak

PASINI ESSENTIAL

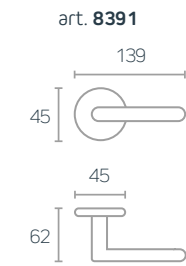

holiday

Material: Zamak

PASINI ESSENTIAL

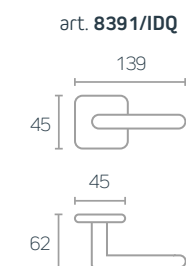
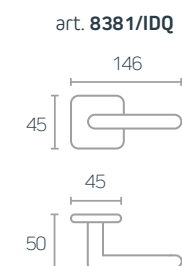
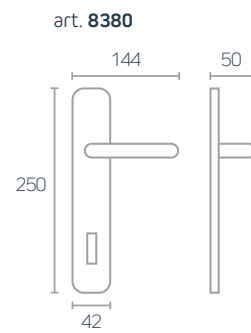



emir emir2

Material: Zamak

PASINI ESSENTIAL

art. 3861

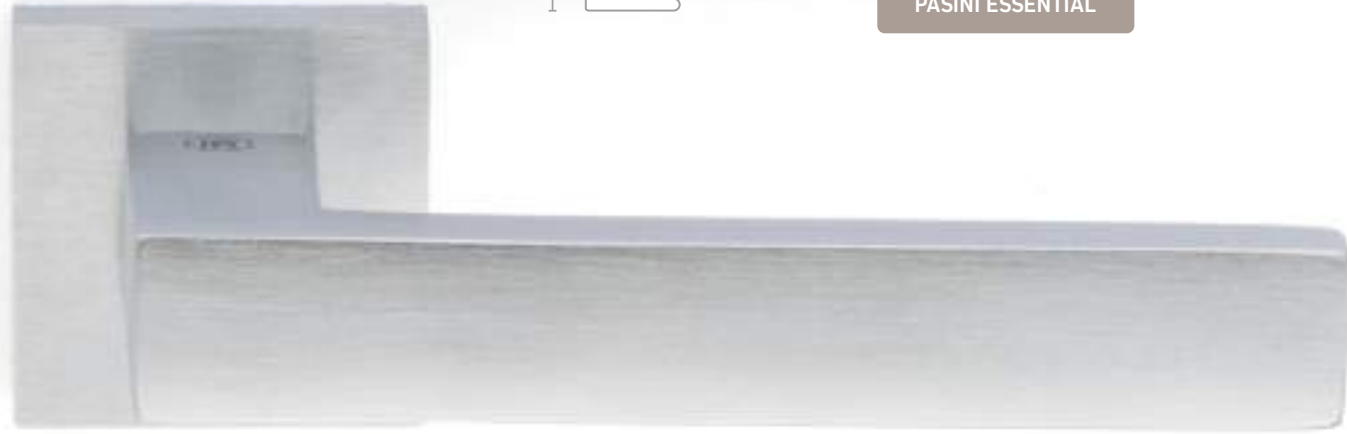
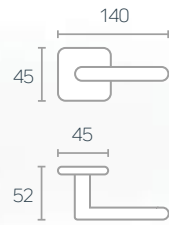

drop

Material: Zamak

PASINI ESSENTIAL

art. 3881

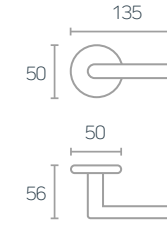

art. 3860

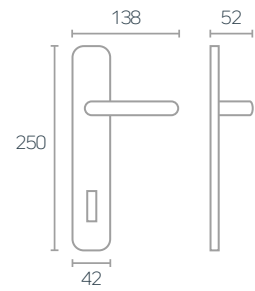

art. 3871

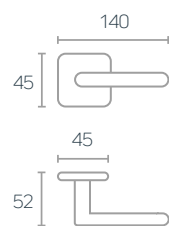

art. 3880

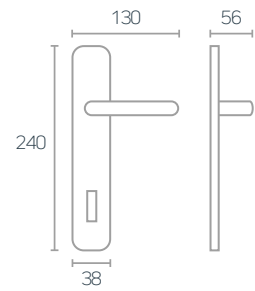

art. 3881

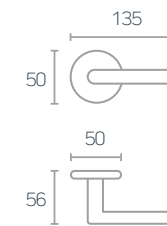

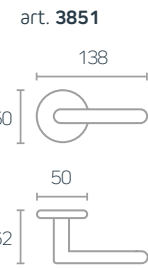

star

Material: Solid Brass

PASINI ESSENTIAL

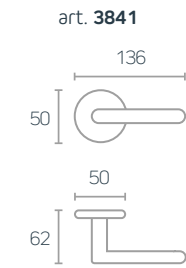
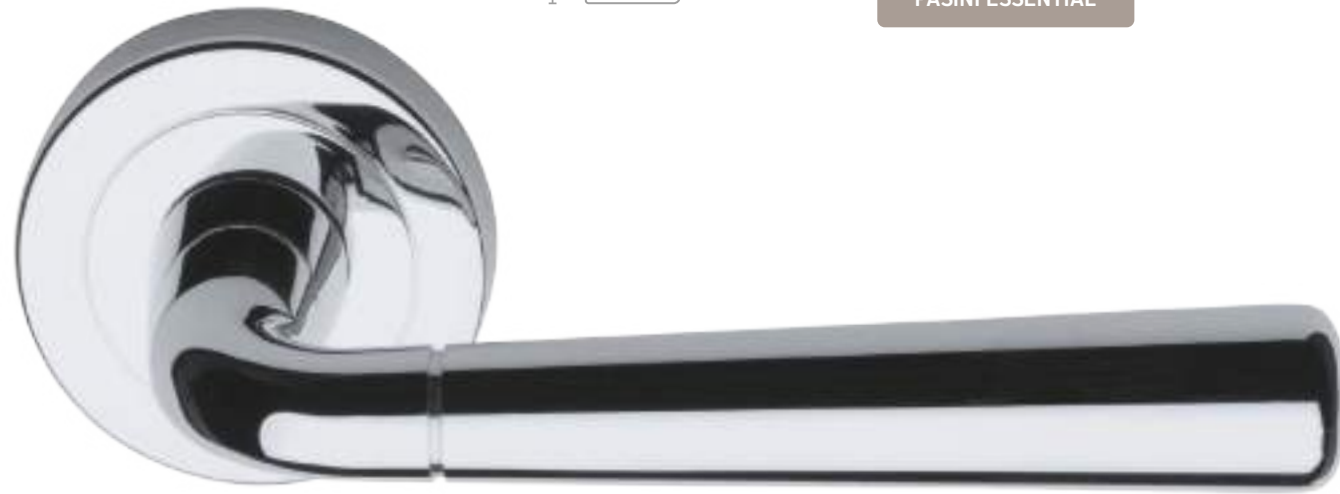

diva

Material: Solid Brass

PASINI ESSENTIAL

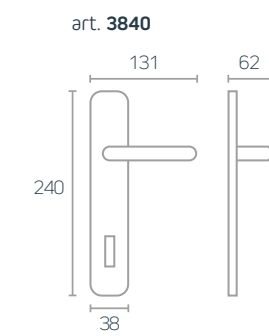
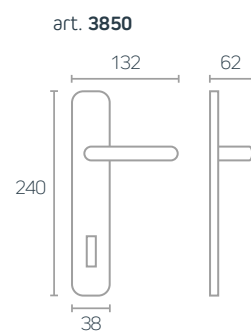

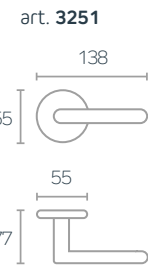

giza

Designer: Angiolino Dolcetti
Material: Solid Brass

PASINI ESSENTIAL

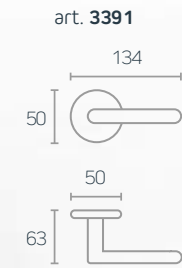
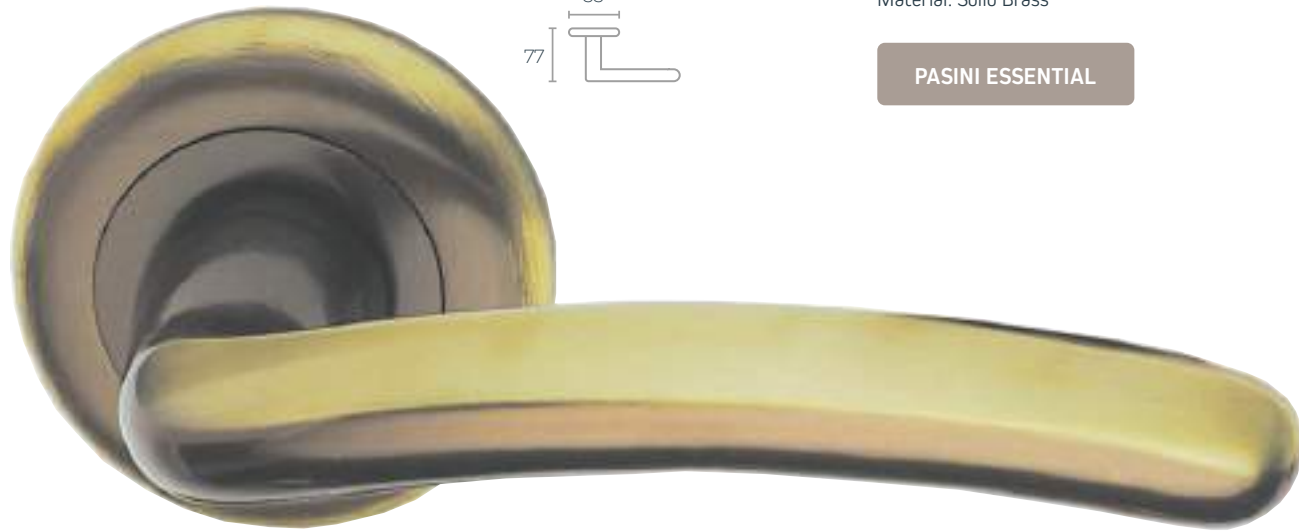

planet

Material: Solid Brass

PASINI ESSENTIAL

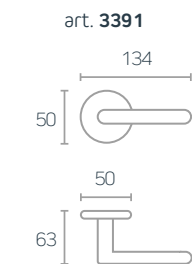
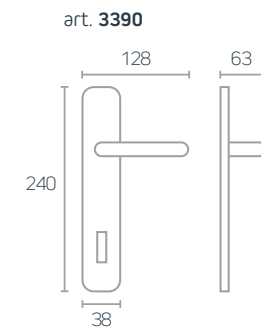
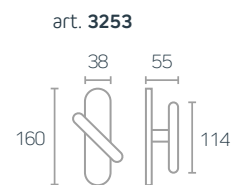
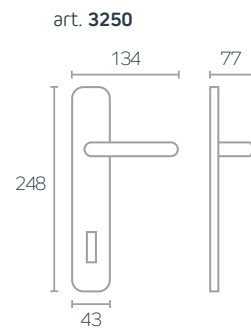

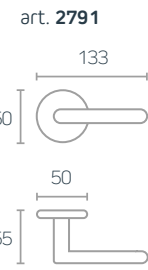

sitia

Material: Solid Brass

PASINI ESSENTIAL

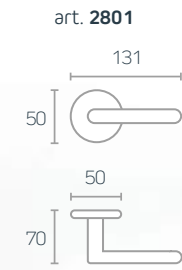

lucy

Material: Solid Brass

PASINI ESSENTIAL

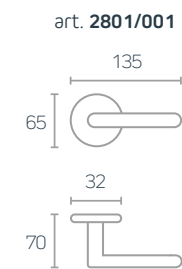
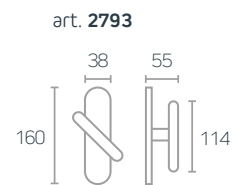
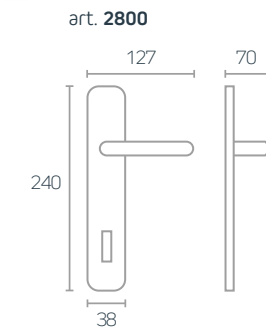
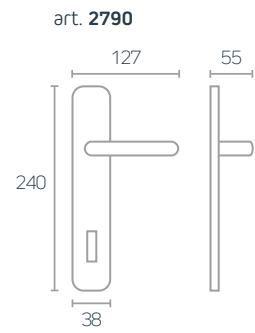



art. 2411

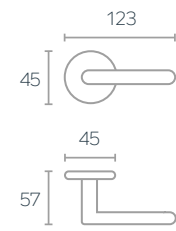

delta

Material: Solid Brass

PASINI ESSENTIAL



art. 1021



maya

Material: Solid Brass - Porcelain

PASINI ESSENTIAL



art. 2410

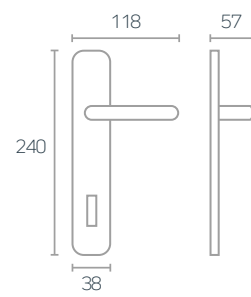

art. 1020

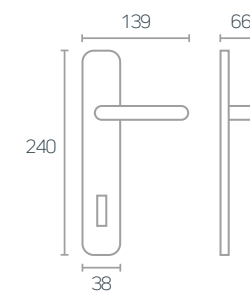

art. 2951

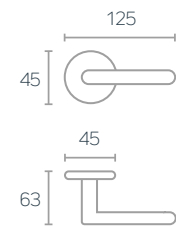

anna

Material: Solid Brass

PASINI ESSENTIAL



art. 0021

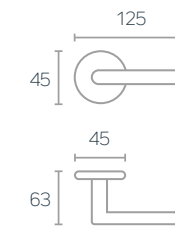

luna

Material: Solid Brass

PASINI ESSENTIAL



art. 2950

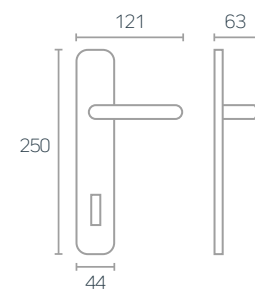

art. 2953

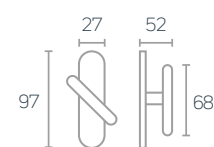

art. 0020

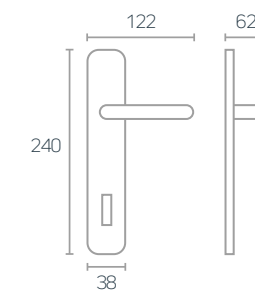

art. 0023

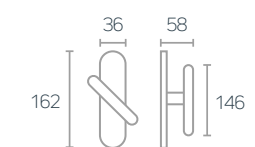

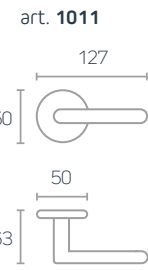

valencia

Material: Solid Brass

PASINI ESSENTIAL

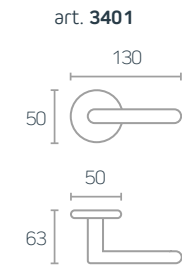

gamma

Material: Solid Brass

PASINI ESSENTIAL

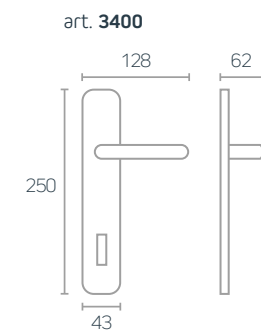
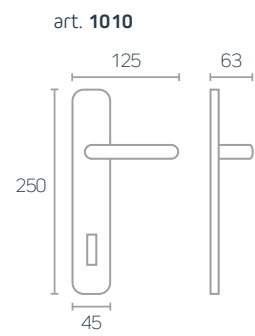

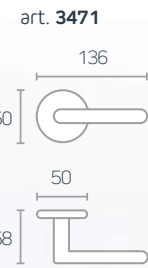

ninfa

Material: Solid Brass

PASINI ESSENTIAL

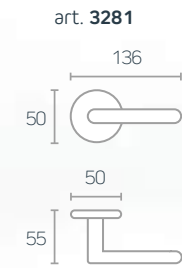

dena dena2

Material: Solid Brass

PASINI ESSENTIAL

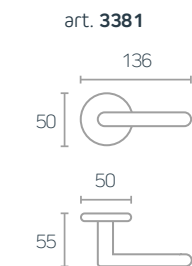
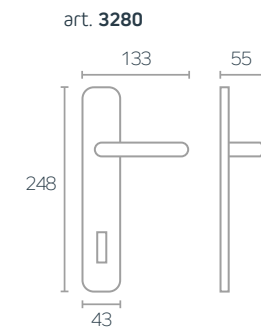
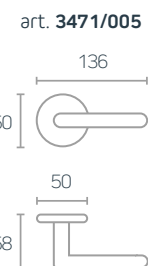
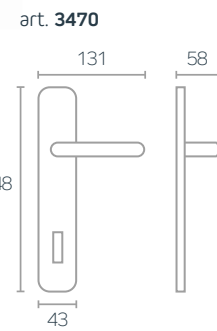



art. 3321

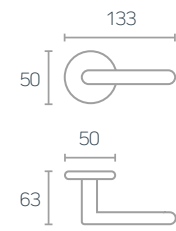

pulsar

Material: Solid Brass

PASINI ESSENTIAL

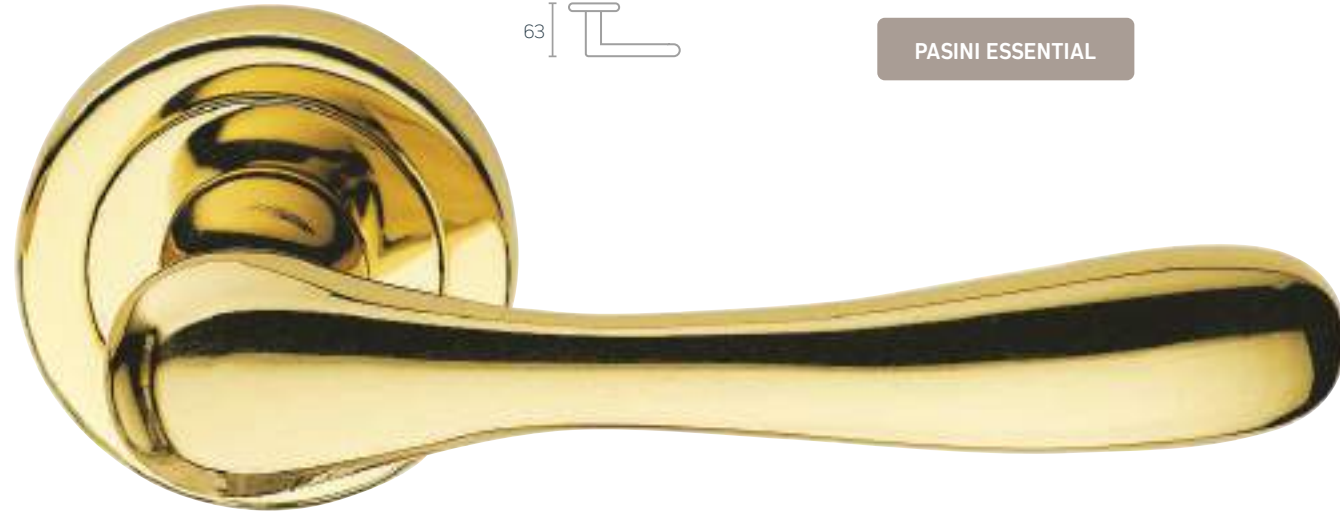

art. 3511

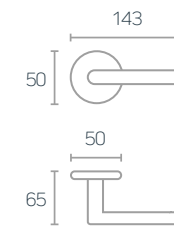

alfa

Material: Solid Brass - Wood

PASINI ESSENTIAL

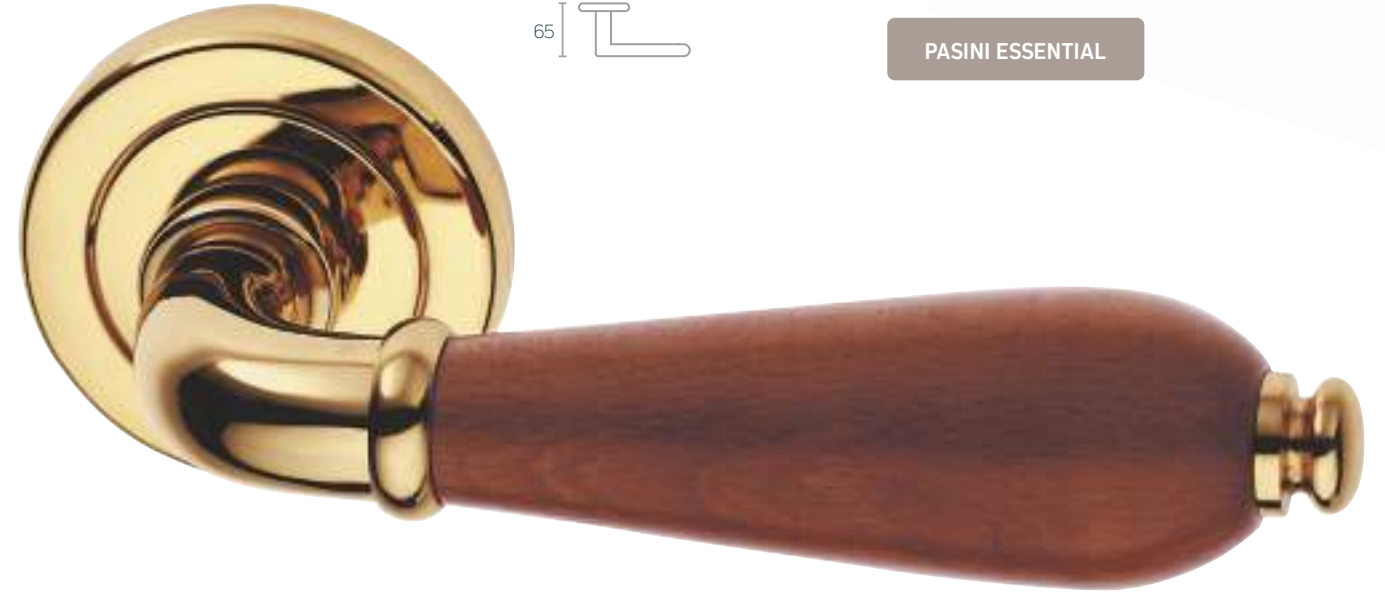

art. 3320

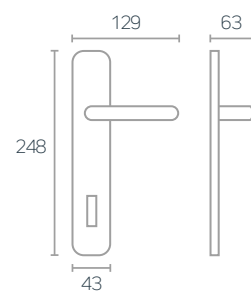

art. 3510

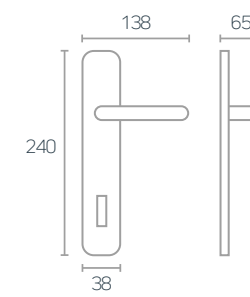



art. 3651

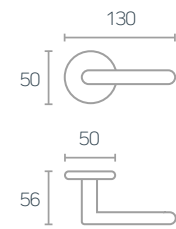

eco

Material: Solid Brass

PASINI ESSENTIAL



art. 3271

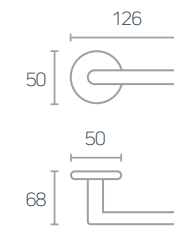

piatta

Material: Solid Brass

PASINI ESSENTIAL



art. 3650

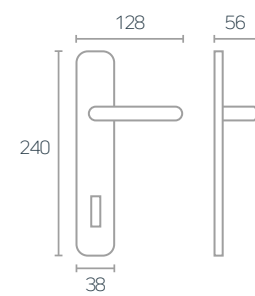

art. 3270

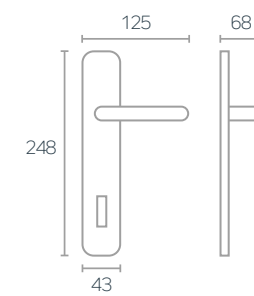

**Maniglioni
Pasini Classic**
Maniglioni che
esprimono lo stile
che ci appassiona
da due generazioni.

**Pasini Classic
pull handles**
Pull handles of the
authentic tradition,
that we express since
two generations.

maniglioni Classic

I maniglioni Classic di Pasini arredano e valorizzano ville, palazzi e dimore storiche in tutto il mondo. Questi oggetti si caratterizzano per uno spiccato senso della tradizione ed un sapiente uso di materiali pregiati e finiture esclusive. Raffinati maniglioni creati per durare nel tempo e diventare prestigiosi oggetti di antiquariato che aprono con eleganza e sicurezza le porte del vostro mondo.

Pasini's Classic pull handles furnish and enhance villas, palaces and historic homes all over the world. These objects are characterized by a marked sense of tradition and a wise use of precious materials and exclusive finishes. Refined pull handles created to last in time and become prestigious antiques objects that open with elegance and safety the doors of your world.

caduceo

Designer: Angiolino Dolcetti
Material: Solid Brass

art. 0138

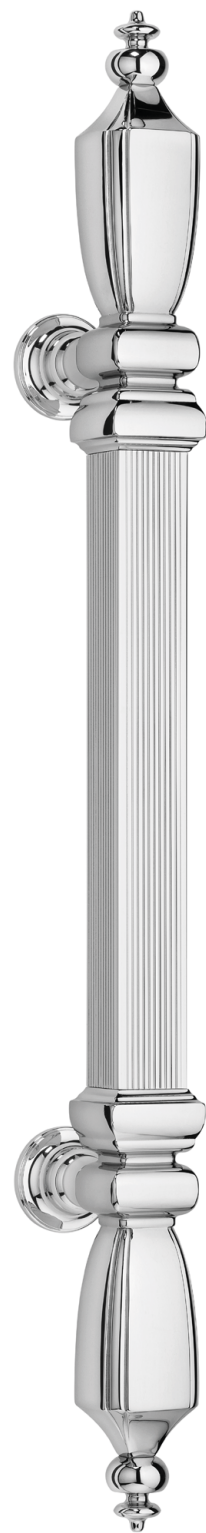
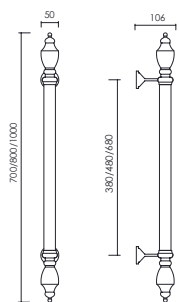

scetto

Designer: Angiolino Dolcetti
Material: Solid Brass

art. 0119

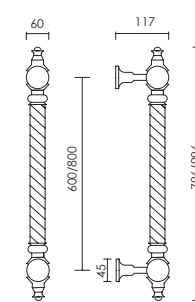

scetto gambo spostato

Designer: Angiolino Dolcetti
Material: Solid Brass

art. 0119S

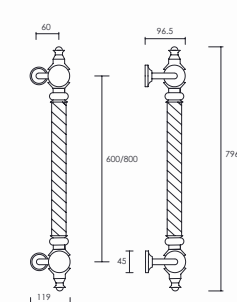

minerva

Designer: Pasini Studio
Material: Solid Brass

art. 0143

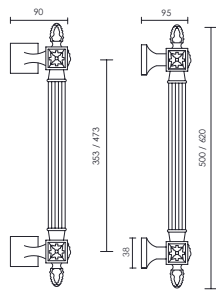

micerino rosetta grande

Designer: Pasini Studio
Material: Solid Brass

art. 0139

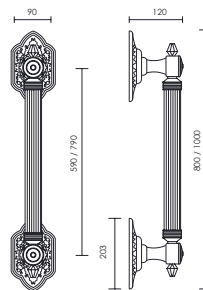

micerino

rosetta piccola

Designer: Pasini Studio
Material: Solid Brass

art. 0140

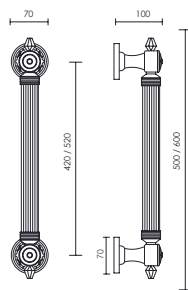

manila

Material: Solid Brass

art. 0200

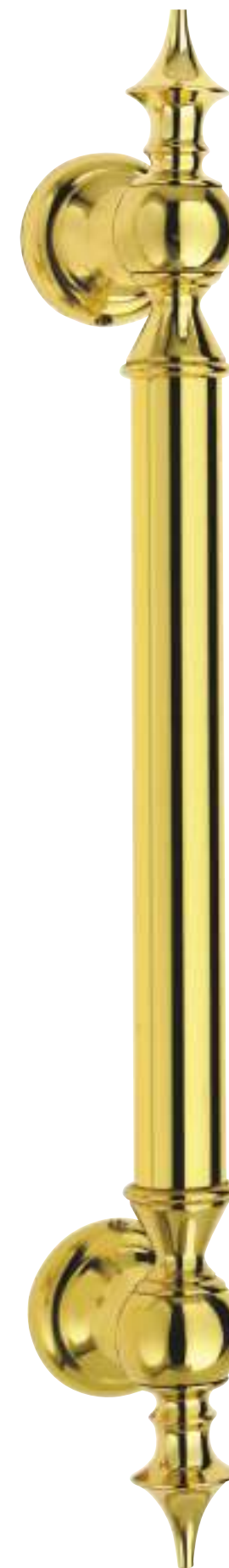
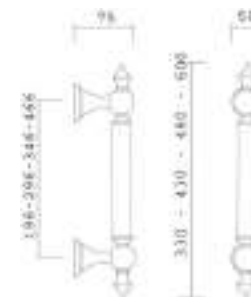



manila

gambo spostato

Material: Solid Brass

art. 0200S

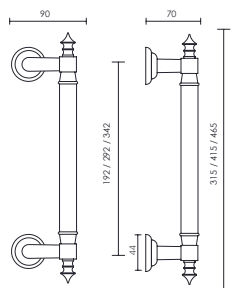

perseo

Material: Solid Brass

art. 0149

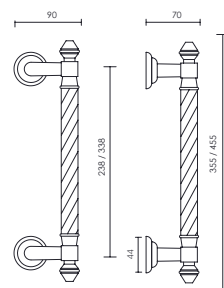

mida

Material: Solid Brass

art. 00151

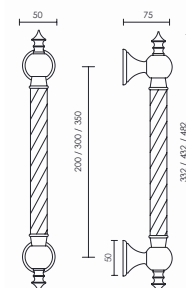

mida

gambo spostato

Material: Solid Brass

art. 0152

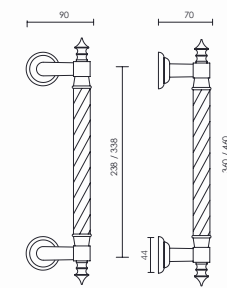

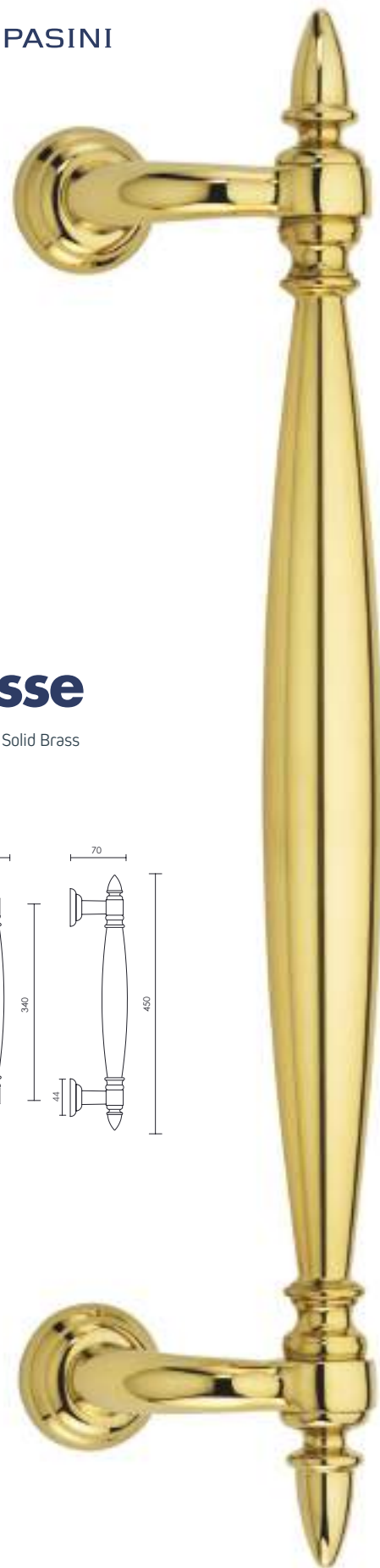

ulisse

Material: Solid Brass

art. 0142

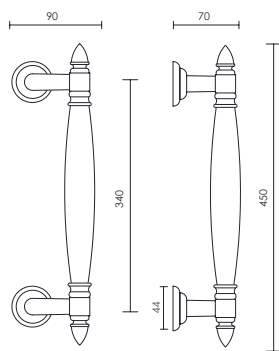

efeso

Material: Solid Brass

art. 0144

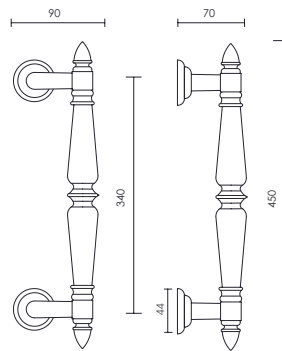

petra

Material: Solid Brass

art. 8215

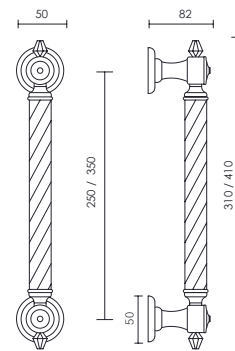

dafne

Material: Solid Brass

art. 0148

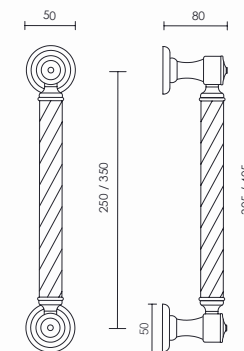



impero

Material: Solid Brass

art. 0220

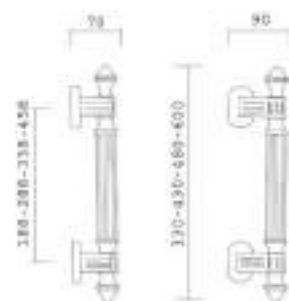

impero gambo rodi

Material: Solid Brass

art. 0223

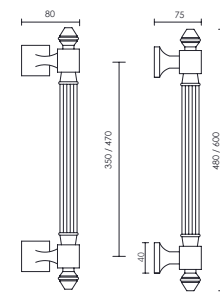

impero
gambo dritto

Material: Solid Brass

art. 0222

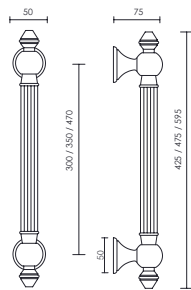

PASINI CLASSIC

davao

Material: Solid Brass

art. 00150

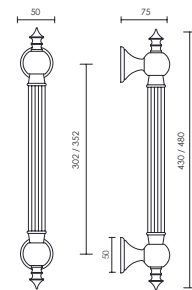

creta

Material: Solid Brass

art. L652/2

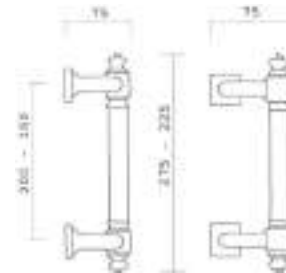

PASINI CLASSIC



pireo
Material: Solid Brass

art. 0210/0211/L210

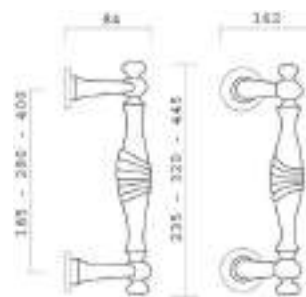

venezia
Material: Solid Brass

art. 0560 / 0560-2 / 0560-3

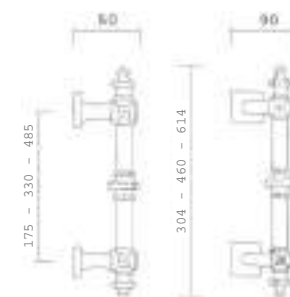

zodiaco lyon

Designer: PFS Original Project
Material: Solid Brass

art. 0256

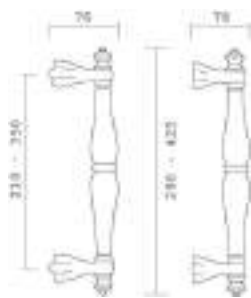

zodiaco virgo

Designer: PFS Original Project
Material: Solid Brass

art. 0255

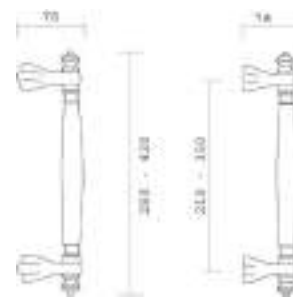



royal righe

Designer: PFS Original Project
Material: Solid Brass

art. 0412

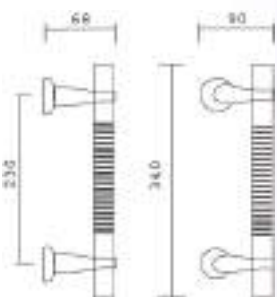

royal liscio

Designer: PFS Original Project
Material: Solid Brass

art. 0411

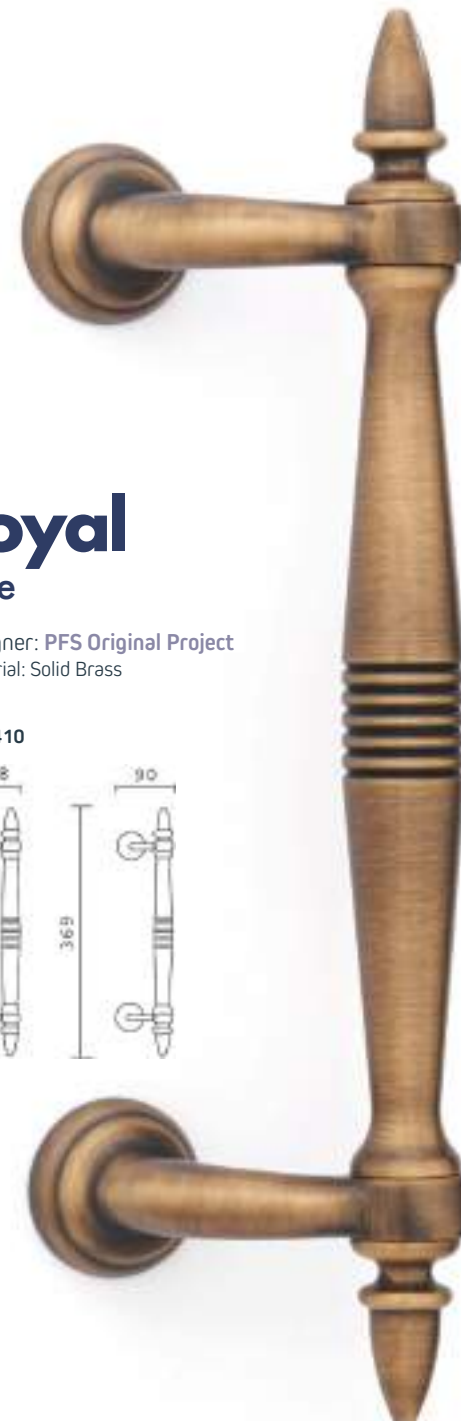
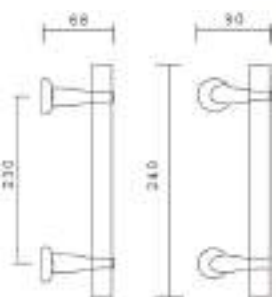

royal style

Designer: PFS Original Project
Material: Solid Brass

art. 0410

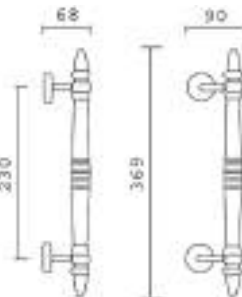

giava gambo royal

Designer: PFS Original Project
Material: Solid Brass

art. 0107/R

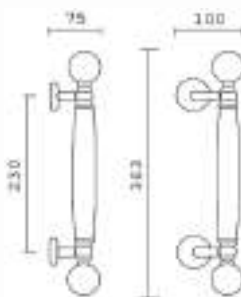

moneta

Material: Solid Brass

art. L650

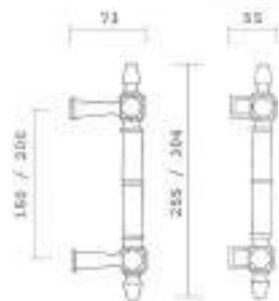

rodi

Material: Solid Brass

art. L651

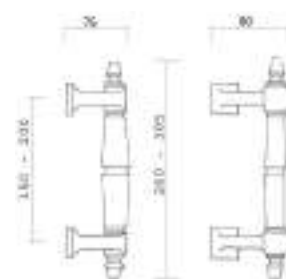

creta gambo tondo

Material: Solid Brass

art. 0656

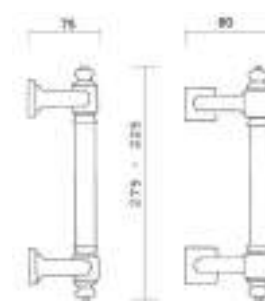

cipro

Material: Solid Brass

art. 0653

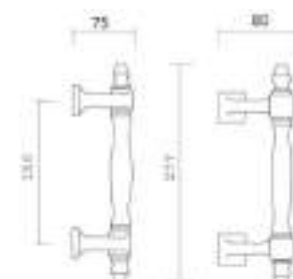

pegaso fondo

Material: Solid Brass

art. 8515

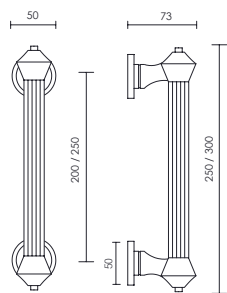

pegaso quadrato

Material: Solid Brass

art. 8515/Q

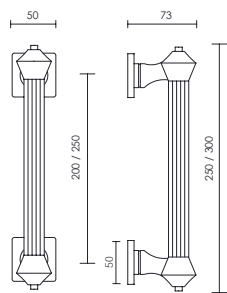

mod.800 dritto

Material: Solid Brass

art. 0035

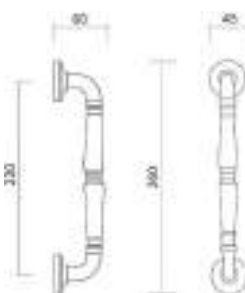

mod.800 spostato

Material: Solid Brass

art. 0035S

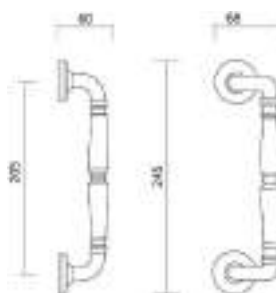



patrizio

Material: Solid Brass

art. 0550

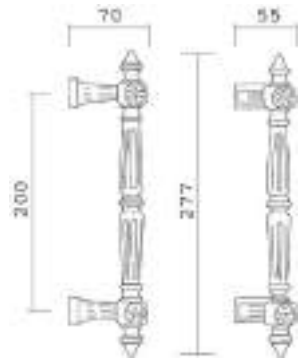

sorriso

Material: Solid Brass

art. 0069

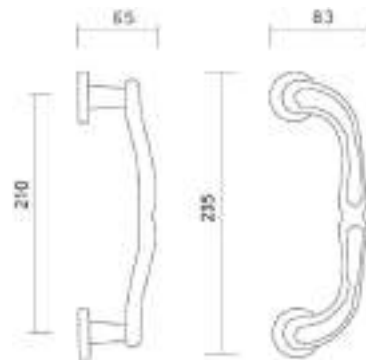

vela

Material: Solid Brass

art. 4020

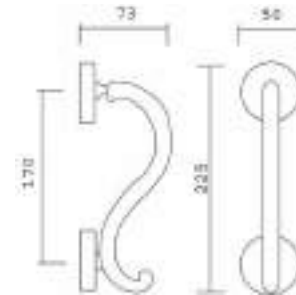

lybra

Designer: Angiolino Dolcetti
Material: Solid Brass

art. 3155

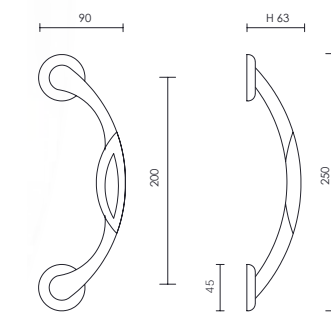

princess

Designer: Angiolino Dolcetti
Material: Solid Brass

art. 3785

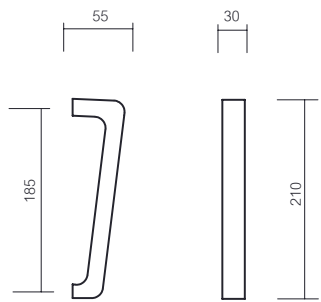

princess su placca

Designer: Angiolino Dolcetti
Material: Solid Brass

art. 3725/P

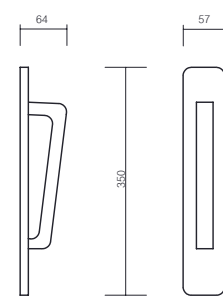

king

Designer: Angiolino Dolcetti
Material: Solid Brass

art. 3725

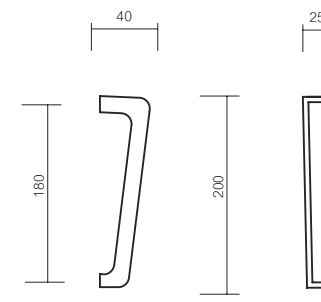

olimpia

Material: Solid Brass

art. 4004



alzante scorrevole

Material: Solid Brass

art. 3547

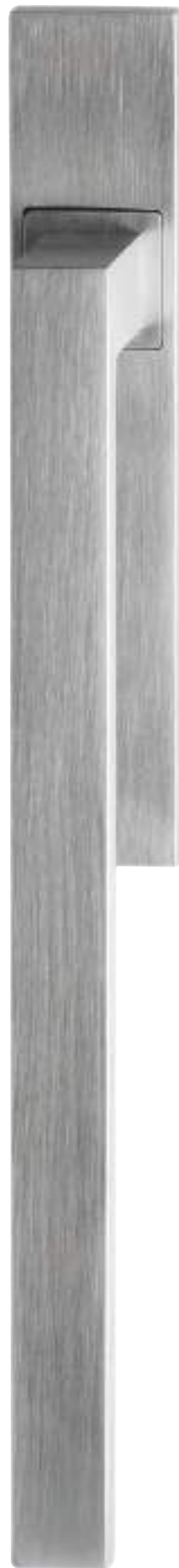
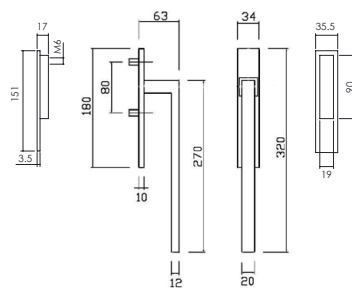

alzante scorrevole ovale

Material: Solid Brass

art. 3546

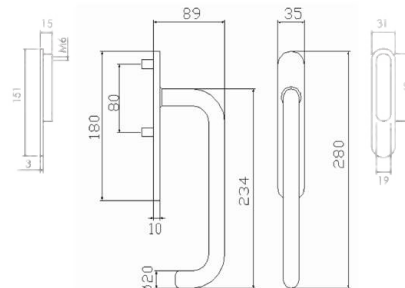

**Maniglioni
Pasini Design**
Maniglioni eleganti
e di classe che
affascinano
ed incantano.

**Pasini Design
pull handles**
Elegant pull handles
that charme and
seduce you.

maniglioni Design

I maniglioni Pasini Design sono ricercati per lo stile contemporaneo, innovativo e originale. Infatti si presentano con caratteristiche uniche che meravigliano. Linee sottili e raffinate, sinuose ed eleganti rappresentano oggi un nuovo standard creativo per i maniglioni. I maniglioni Pasini Design assecondano il tuo desiderio d'innovazione regalando l'aspetto che desideri alle porte d'ingresso nel tuo mondo.

Pasini's Design handles are refined for the contemporary, innovative and original style. In fact, their unique features are amazing. Slender, refined, sinuous and elegant lines today represent a new creative standard for handles. Pasini's Design pull handles satisfy your desire of innovation by giving the look you want to the doors of your world.



PASINI DESIGN

delfino

Designer: Angiolino Dolcetti
Material: Solid Brass

art. 0420

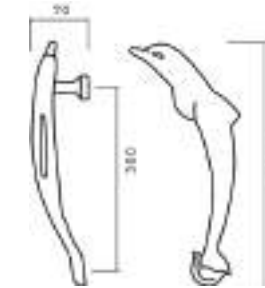

airone

Designer: Angiolino Dolcetti
Material: Solid Brass

art. 0422

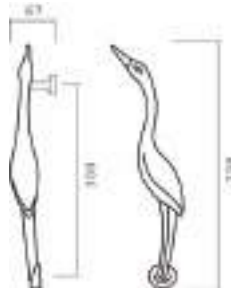

pantera

Designer: Angiolino Dolcetti
Material: Solid Brass

art. 0421

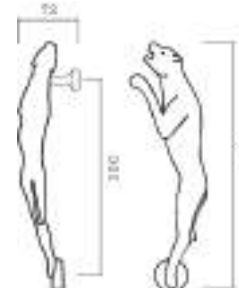

techno

mm. 350 dritto

Designer: Pasini Studio
Material: Solid Brass

art. 4060

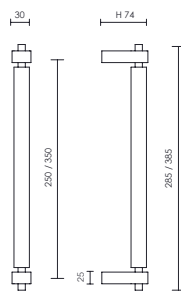

techno

mm. 250 dritto

Designer: Pasini Studio
Material: Solid Brass

art. 4060

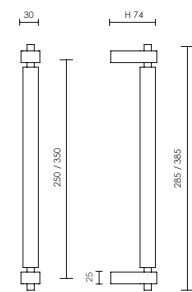

techno

mm. 350 spostato

Designer: Pasini Studio
Material: Solid Brass

art. 4061

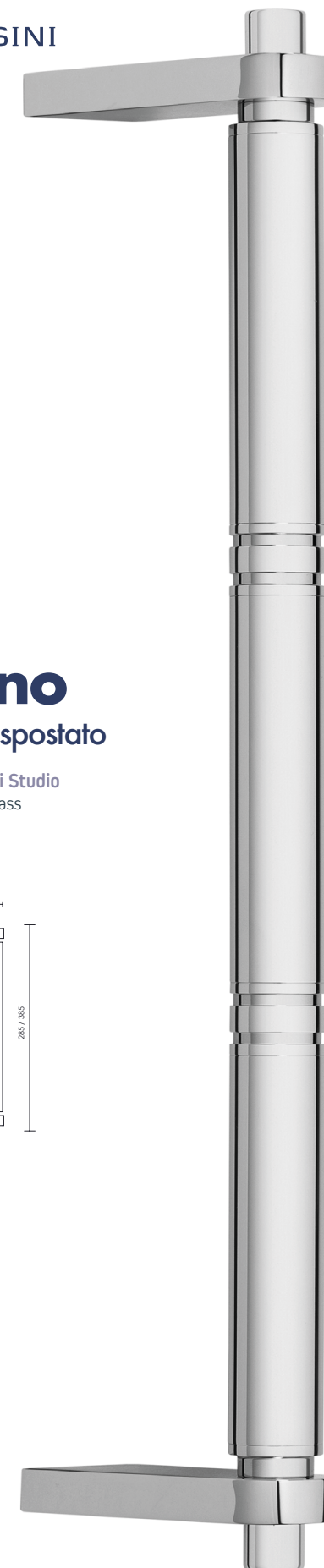
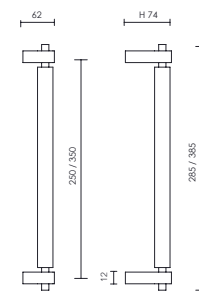

techno

mm. 250 spostato

Designer: Pasini Studio
Material: Solid Brass

art. 4061

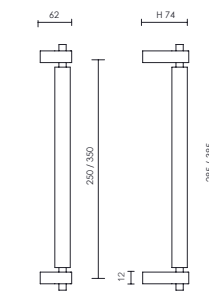

techno
mm. 350 grip

Designer: Pasini Studio
Material: Solid Brass

art. 4070

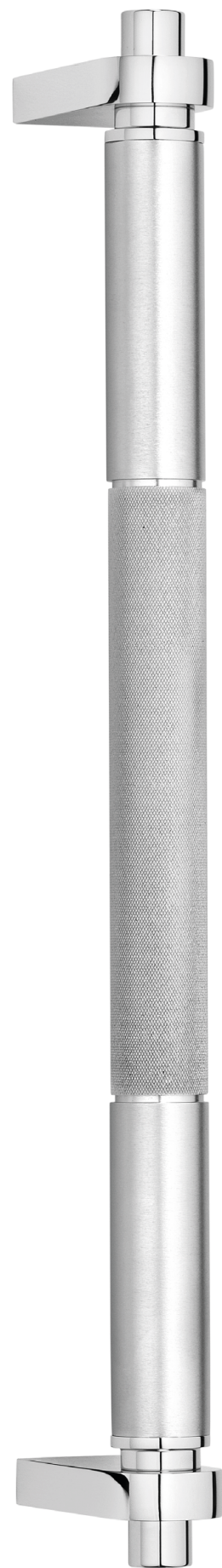
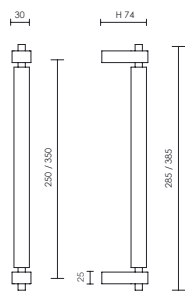

techno
mm. 250 grip

Designer: Pasini Studio
Material: Solid Brass

art. 4070

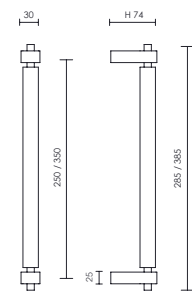

techno
mm. 350 grip spostato

Designer: Pasini Studio
Material: Solid Brass

art. 4071

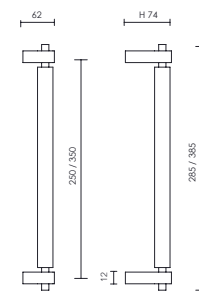

techno
mm. 250 grip spostato

Designer: Pasini Studio
Material: Solid Brass

art. 4071

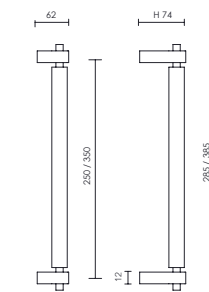



galassia

Material: Solid Brass

art. 3028

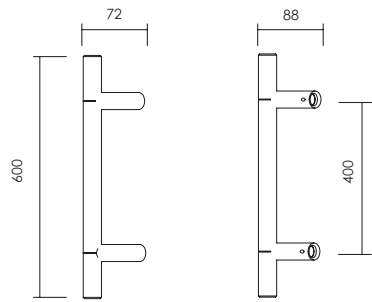

spazio

Designer: PFS Original Project
Material: Stainless Steel

art. 0413

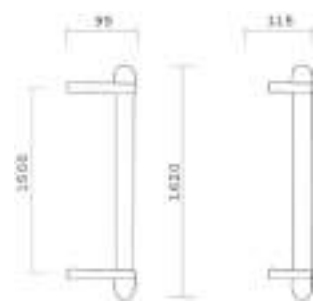

antares quadrato

Material: Aluminium

art. 3037

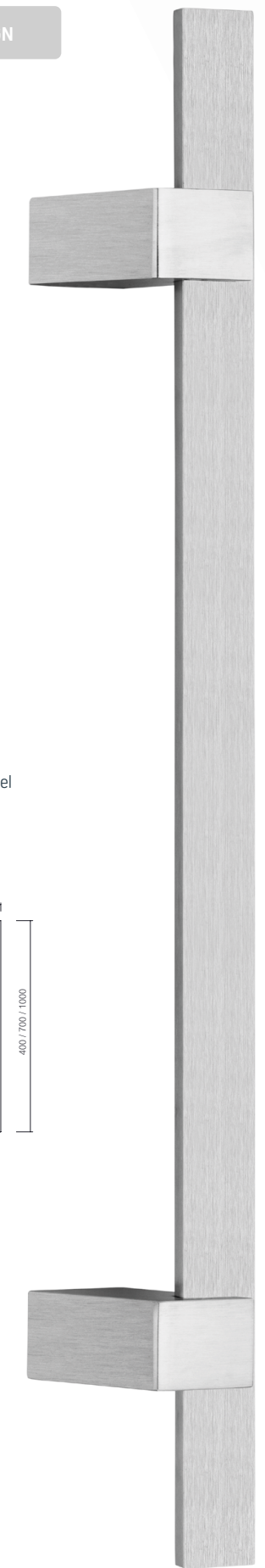
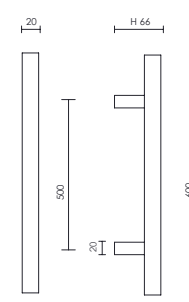

orion inox

Material: Stainless Steel

art. 3036

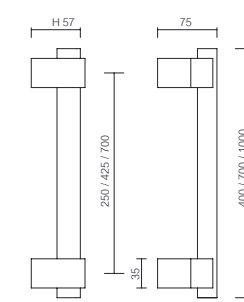

polluce

Material: Aluminium

art. 3038

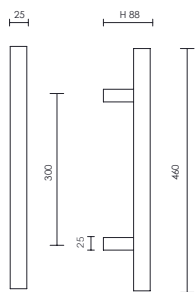

PASINI DESIGN

polluce gambo spostato

Material: Aluminium

art. 3038S

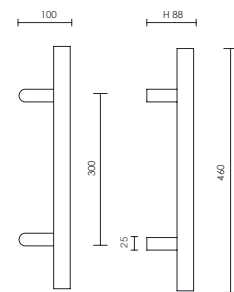

marte

Material: Solid Brass

art. 4050

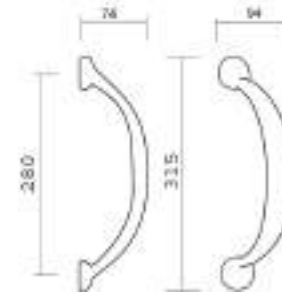

PASINI DESIGN

venere

Designer: Angiolino Dolcetti
Material: Solid Brass

art. 0140

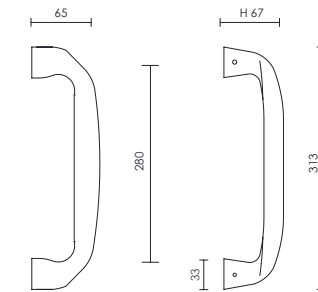

rimira

Designer: Atelier Due
Material: Solid Brass

art. 0118/CI

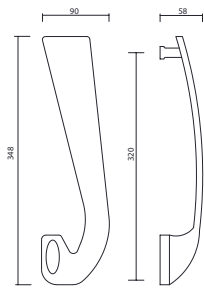

rimira con defender

Designer: Atelier Due
Material: Solid Brass

art. 0118

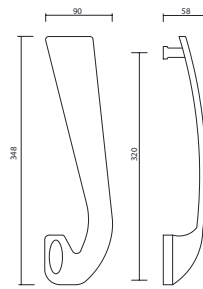

arona

Material: Solid Brass

art. M2602

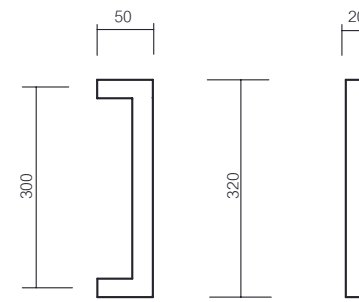

luna

Material: Solid Brass

art. 0111

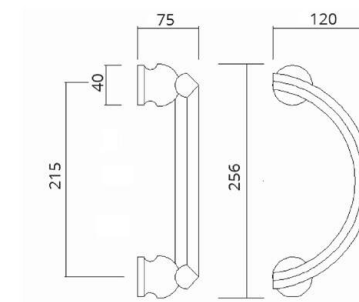



trend

Designer: PFS Original Project
Material: Solid Brass

art. 0315

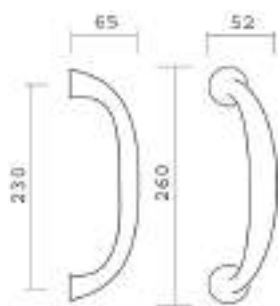

acquarius

Designer: PFS Original Project
Material: Solid Brass

art. 0244

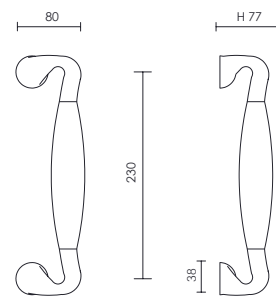

windows arco

Designer: PFS Original Project
Material: Solid Brass

art. 3005/B

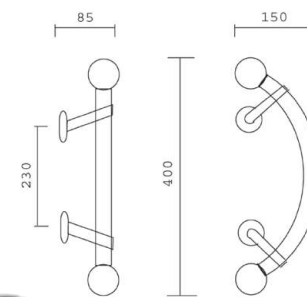

windows dritto

Designer: PFS Original Project
Material: Solid Brass

art. 3000/D

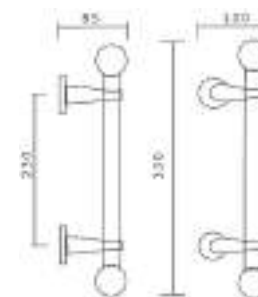



cono

Material: Solid Brass

art. 0109

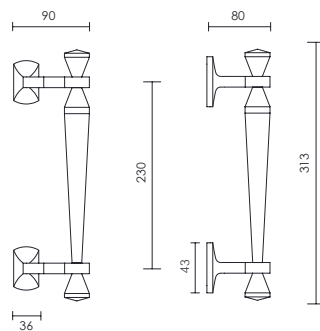

giava

Designer: PFS Original Project
Material: Solid Brass

art. 0107

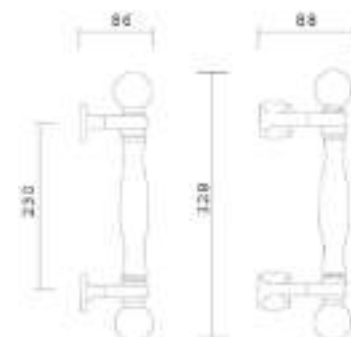

esagonale

Designer: PFS Original Project
Material: Solid Brass

art. 0105

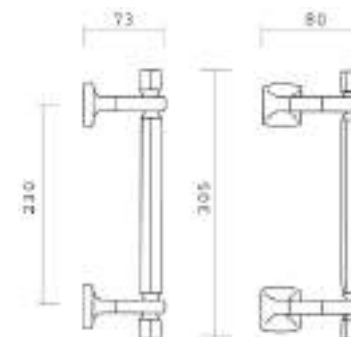

semitondo

Designer: PFS Original Project
Material: Solid Brass

art. 0106

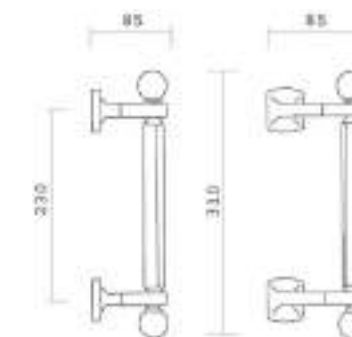



micene

Designer: PFS Original Project
Material: Solid Brass

art. 0108

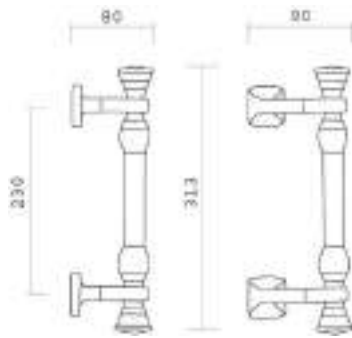

micene gambo dritto

Material: Solid Brass

art. 0108/D

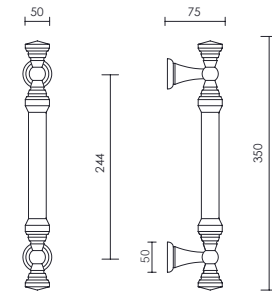

berlino point

Material: Stainless Steel

art. 6106

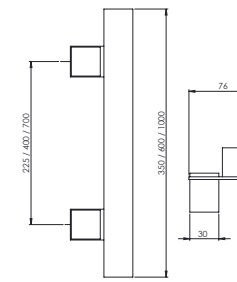

berlino liscio

Material: Stainless Steel

art. 6106L

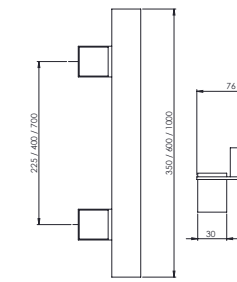



giza

Designer: Angiolino Dolcetti
Material: Solid Brass

art. 3255

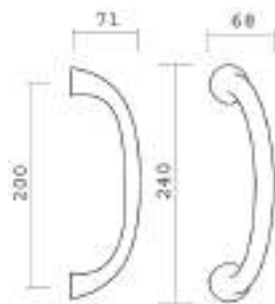

zeta

Material: Solid Brass

art. 0441

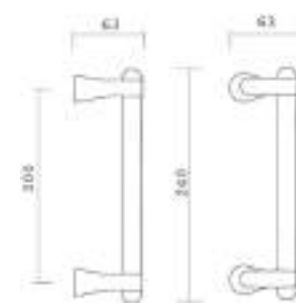

quadrato

Designer: Angiolino Dolcetti
Material: Solid Brass

art. 0117

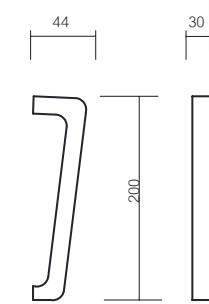

quadrato su placca

Designer: Angiolino Dolcetti
Material: Solid Brass

art. 0117/

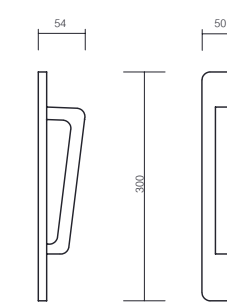



accessori

5030

naos

Material: Solid Brass

art. 5030



0530

quadrato

art. 0530

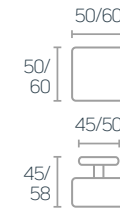

0540

corolla

art. 0540

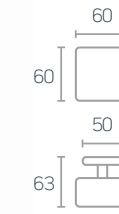

5034

superba

Material: Solid Brass

art. 5034



0310

trend

art. 0310

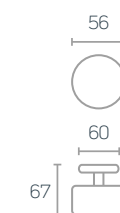

0525

princess

art. 0525



0280

margherita

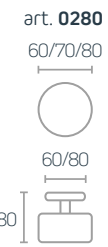

2400

delta



0900

barocco

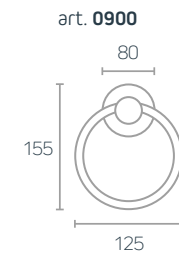

0910

pireo

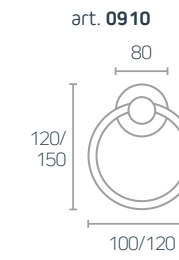

2300

mod.800

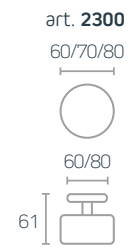

0430

king

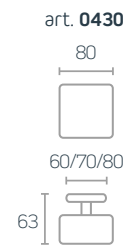

0920

luxor

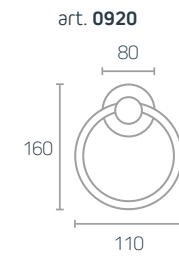

0940

testa di leone

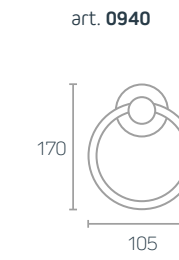

0950

anello

art. 0950

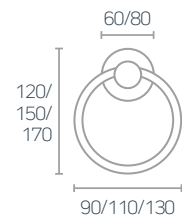

0960

luna

art. 0960

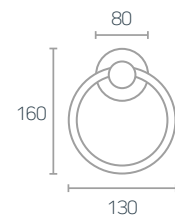

2000

esagono

art. 2000

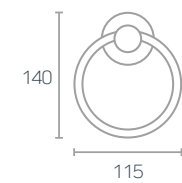

3687

triangolo

art. 3687

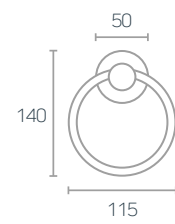

0116

pendente
pl beta



3114

ovale
pl 3114



3114/3522

ovale
pl beta



0096 sorriso

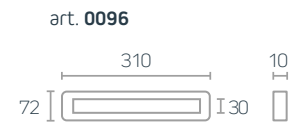

2050 liscia grande fusa



2051 liscia grande stampata



3543/PFC

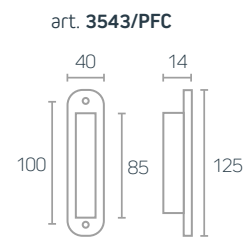

3543/P

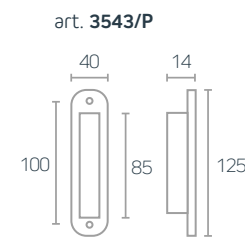

3543/F

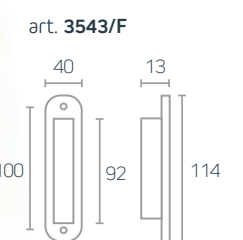

2451

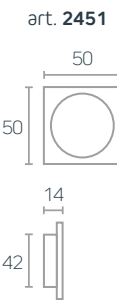
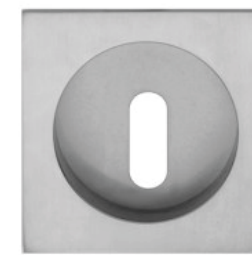

2452

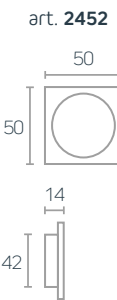
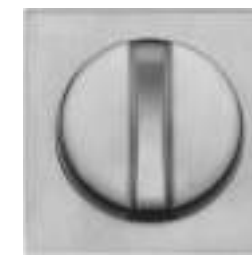

2450

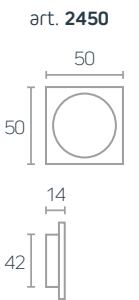
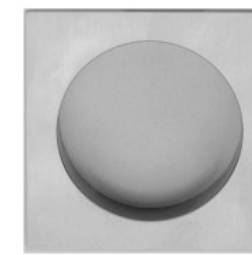

2421



2422

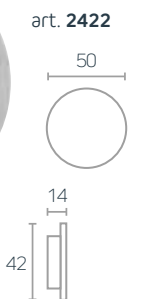

2420

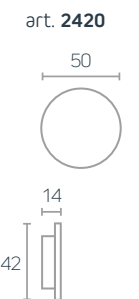
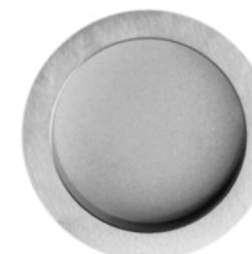

1BFMD **tonda D50**



0496 **foro 8**



9BFY **ovale**



0496 **doppia mappa**



Y0051 **meteor yale**



1BFY **D45**



0496 **doppia mappa**



Y2653 **yale ovale**



8BFY **D50**



0496Y **yale rettangolare**



3BFY **laura**



2BFY **gamma**



191/15 **mm15**
ottone



195/15 **ovale mm15**
ottone



194 **mm10**
esagonale



195/15 **ovale mm15**
inox



192 **mm6**



195 **ovale**



191/15 **rettangolare**
inox



191 **mm10**



10BDEF **mm15**
defender tondo



0011P **artistico**



0010P **liscio**



005P **chiocciola**



0037-0071



0037-3721



0037-8261



008P **cilindro**



0057 **nottolino serrature**



0077 **nottolino doccia 6MA**



0037B



0037R



2657-0091



0087 **nottolino doccia 5MA**



0067 **nottolino a serratura**



2657-3421



2657-3781



2657Q



PS2905



PS2901



PS2900



0132 **queen**
piccola

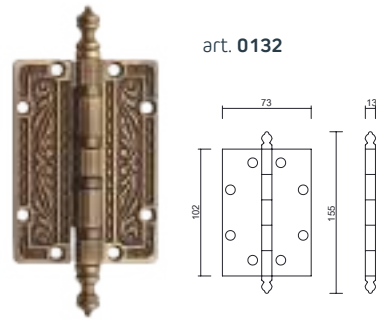

0131 **queen**
grande

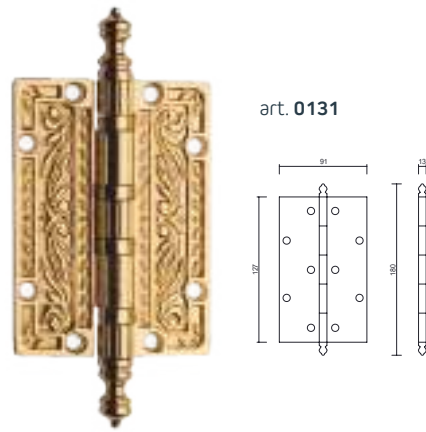

G130 **doppia cristallo**
coppia cerniere



126/3 **piana**

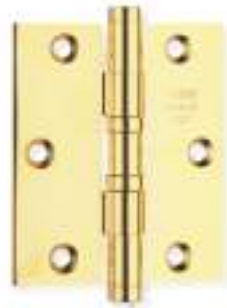

128/4 **piana**



129 **zancata**



0133 **scomparsa**



SER01 **serratura**



CYL01 **cilindro**



0492 **verticale** mm 300 - 400



0493 **catenaccio** mm 150 - 200 - 250



0491 **con incastri** mm 80 - 100 - 120 - 200

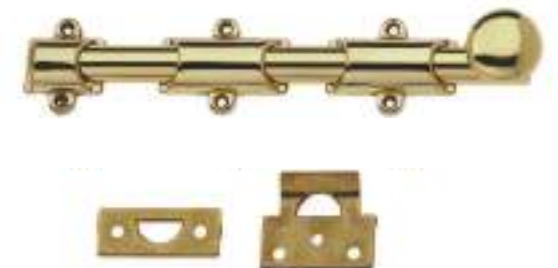

5070 **uomo-donna**
segnalino bagno



5071 **pipa-scarpa**
segnalino bagno



5072 **bagno WC**
segnalino



5073 **toilette**
segnalino



KIT 1 fissaggio singolo passante per porte: legno, alluminio, pvc, blindate



KIT 2 fissaggio singolo passante per porte: vetro

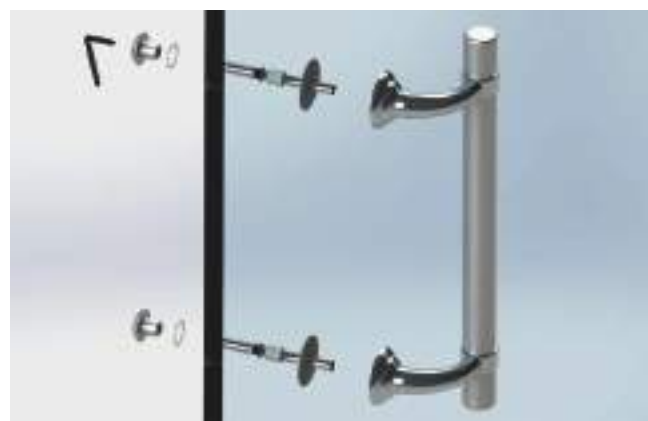

KIT 3 fissaggio coppie per porte: legno, alluminio, pvc, blindate



KIT 4 fissaggio coppie per porte: vetro



KIT 5 fissaggio singolo non passante per porte: legno, alluminio, blindate



KIT 6 fissaggio singolo non passante per porte: alluminio blindate



KIT 7 fissaggio maniglione singolo con boccola



KIT 8 fissaggio maniglioni doppi con boccola



KIT 15 fissaggio maniglione singolo / inox / passante



KIT 16 fissaggio maniglione singolo / inox / non passante



KIT 13 fissaggio alzante scorrevole singolo / con nicchia



KIT 14 fissaggio alzante scorrevole a coppia



KIT 11 fissaggio battente passante



KIT 12 fissaggio battente non passante



KIT 9 fissaggio pomolo passante



KIT 10 fissaggio pomolo non passante



istruzioni di montaggio maniglia su rosetta



sensi di apertura porta

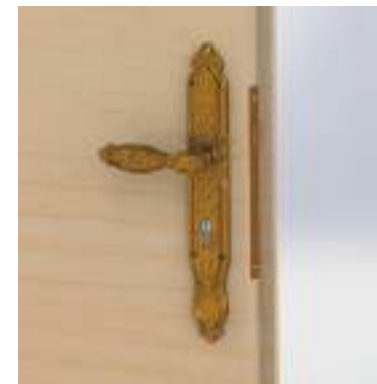

LEFT SIDE

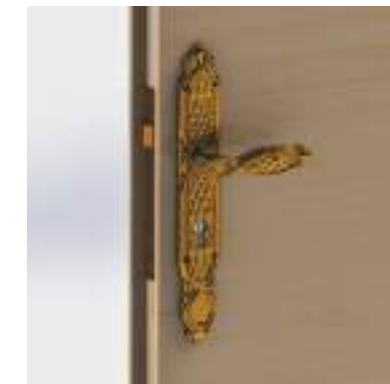

RIGHT SIDE

istruzioni di montaggio bocchette di sicurezza



PASSAGGIO 1



PASSAGGIO 2



PASSAGGIO 3

gioco Gratz
con boccole



gioco Gratz
con boccole +q.7x35



gioco Gratz
senza boccole



gioco Gratz
con perni



gioco MP
per ante esterne



movimento DK
q.7



movimento DK
con boccole



movimento DK
in plastica



Ferri per maniglie e maniglioni
Spindles for handles and pull handles

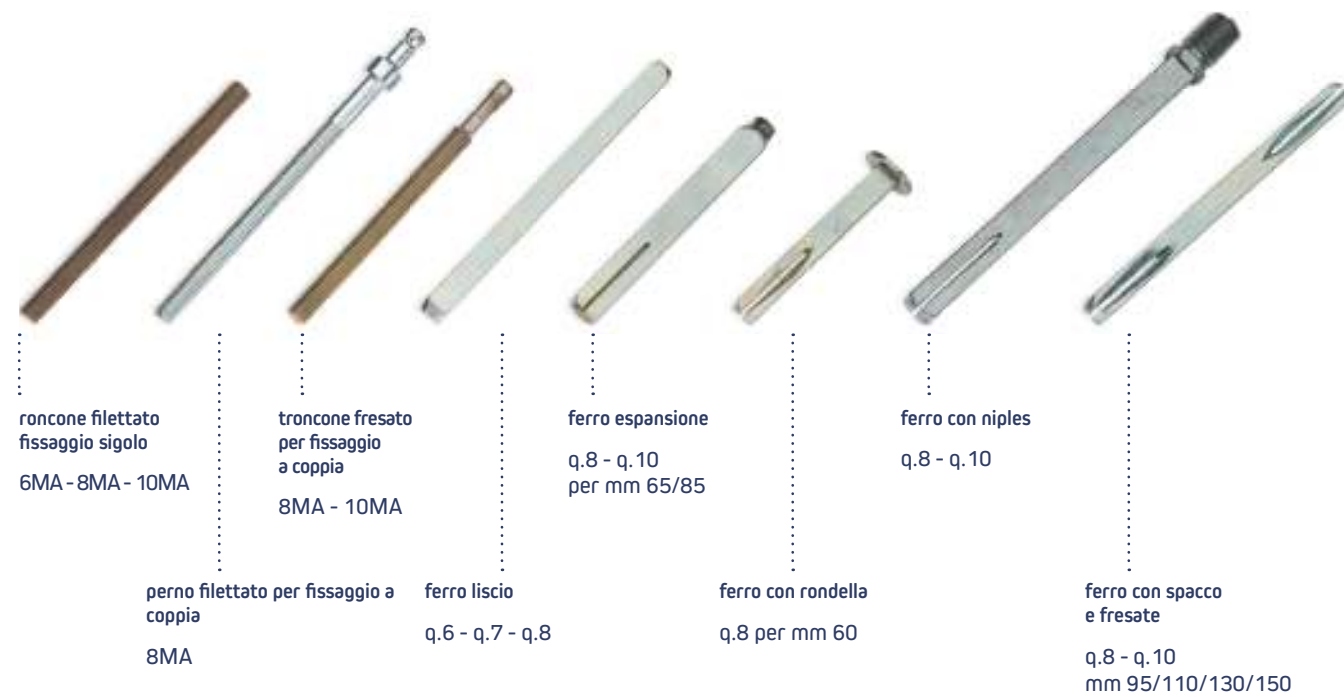

roncone filettato
fissaggio sigolo
6MA - 8MA - 10MA

troncone fresato
per fissaggio
a coppia
8MA - 10MA

ferro espansione
q.8 - q.10
per mm 65/85

ferro con nipples
q.8 - q.10

perno filettato per fissaggio a
coppia
8MA

ferro liscio
q.6 - q.7 - q.8

ferro con rondella
q.8 per mm 60

ferro con spacco
e fresate
q.8 - q.10
mm 95/110/130/150

F12 AVP8

perni fissaggio
singolo non passante m.8



F12 AVPF

perni fissaggio
singolo non passante



B0210

piastrine
fissaggio maniglioni



Piastra 25 q.8

piastrine con quadro
fissaggio pomoli e maniglie non
passanti



17 / 74 / 28 8MA

piastrine con filetto
fissaggio pomoli e battenti
non passante



D8 - DNB - DBB

dadi ciechi
in ottone



M4 - M5 - M6

molla ambidestra



P3720 YDM

king



P3780 YDM

princess

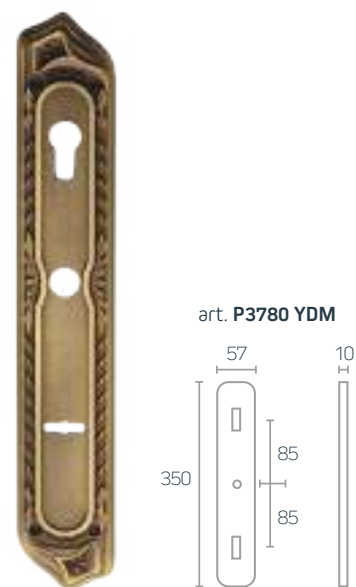

P3540 YDM

quadrata

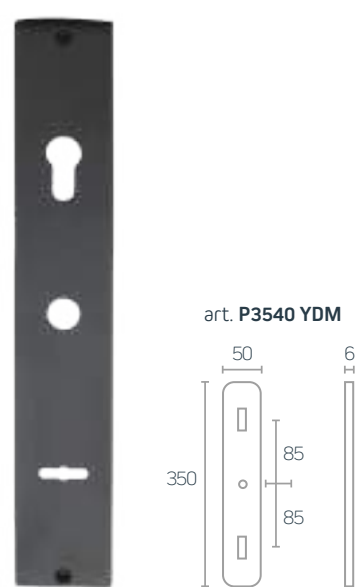

P0050

luna stretta

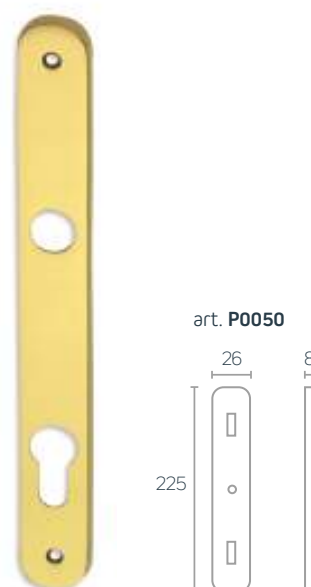

P0030 SM

mod.800

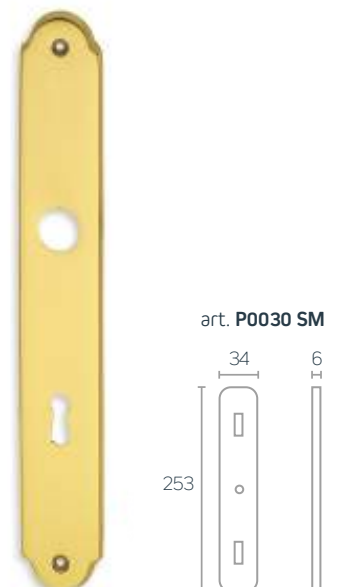

P3440

zar doppia mappa wc

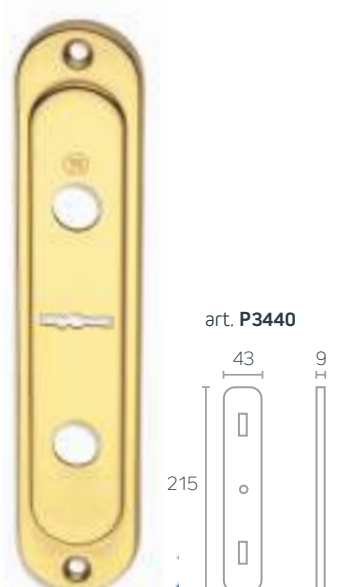

quality and guarantees

Stainless Steel Test



Finitura in PVD Rivestimento metallico sottovuoto in zirconio denominato PVD (Physical Vapor Deposition). Incrementa notevolmente la resistenza all'usura e all'abrasione assicurando una più lunga durata del prodotto e il mantenimento di brillantezza e stabilità del colore nel tempo.

PVD Finishing Metallic zirconium vacuum coating named PVD (Physical Vapor Deposition) increases the resistance to wear, abrasion and rubbing action, granting a longer life, better brightness and colour stability to our products.

Consigli di manutenzione La pulizia ordinaria dei nostri accessori deve essere effettuata ogni 4-6 settimane utilizzando un panno morbido. Per la pulizia ed il mantenimento delle superfici in PVD suggeriamo utilizzo di un panno morbido inumidito con alcool.

Maintenance Tips The ordinary cleaning of our accessories must be effectuated every 4-6 weeks using a smooth cloth. For cleaning and maintenance of PVD surfaces we suggest you to use a smooth cloth with alcohol.

PVD Finish Test

Resistenza all'abrasione | La prova di sfregamento comparata è eseguita con detersivi comuni applicati su un panno strofinando sulla superficie metallica fino ad usura della stessa.

Rubbing Resistance | Comparative rubbing test made with common domestic usage detergent on a cloth which has been rubbed on metallic treated surface until spoiling it.

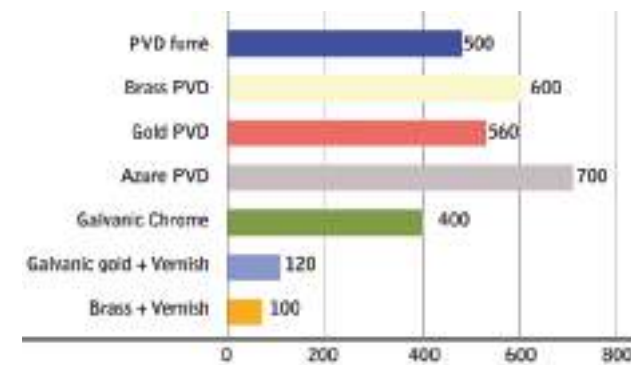

Pasini Metals Productions S.a.S. Condizioni generali di vendita

- Gli ordini diretti oppure assunti dai nostri agenti o rappresentanti sono subordinati alla nostra approvazione.
- I prezzi si intendono IVA esclusa e FRANCO FABBRICA.
- La merce viaggia sempre a rischio e pericolo del compratore anche se venduta franco destino. In mancanza di particolari accordi la spedizione verrà effettuata con mezzi a scelta della venditrice e senza responsabilità alcuna da parte di questa. Le eventuali assicurazioni concernenti i trasporti devono essere assunte dal compratore e gli oneri relativi saranno a carico dello stesso, salvo diversa pattuizione.
- Decorsi otto giorni dal ricevimento della merce, il compratore decadrà da qualsiasi diritto di reclamo per vizio o mancanza di qualità o di peso delle cose compravendute. In caso di tempestivo reclamo, le merci dovranno essere tenute integralmente a disposizione della venditrice per eventuali controlli; la compratrice non potrà farne uso o manometterle, neppure in minima parte, sotto pena di decadenza del diritto di reclamo. Ove la venditrice riconosca fondato il reclamo, la stessa non avrà altro obbligo che quello di sostituire le merci, le quali dovranno essere preventivamente restituite nell'originale stato di presentazione. Ogni ammanco od avaria saranno ad esclusivo carico del compratore. Le misure dei nostri articoli, espresse in millimetri, devono intendersi approssimative e pertanto la venditrice declina ogni responsabilità in ordine alla loro esattezza per eventuali contestazioni.
- Pagamento: Il pagamento delle fatture deve essere effettuato direttamente alla nostra sede in Sabbio Chiese, Via dei Montini 1 entro la scadenza stabilita. In caso di ritardato pagamento verranno applicati gli interessi di mora. La merce rimane di proprietà della Pasini Metals Productions S.a.S. fino al completo pagamento.
- Ci riserviamo il diritto di modificare le caratteristiche dei nostri articoli o di correggere eventuali difetti in ogni momento senza preavviso ai clienti.
- Per qualunque contestazione resta espressamente convenuta la competenza esclusiva del Foro di Brescia.
- Il committente, sottoscrivendo ordinazione, dichiara di conoscere ed accettare integralmente tutte le condizioni suesposte, come pure quelle manoscritte o dattiloscritte sul contratto.

Pasini Metals Productions S.a.S. General Sales Conditions

- All direct orders and those placed by our agents, are subject to our approval.
Prices are intended ex-works and V.A.T. excluded.
- Goods are forwarded at the buyer's own risk, even when the sale is carriage free. Unless otherwise stated, the means of transport for the forwarding will be chosen by the seller without any responsibility whatsoever on his part. Unless otherwise agreed, all possible insurance regarding transport must be contracted by the buyer and all expenses deriving from it will be at the buyer's own charge.
- Eight days after receipt of the goods, the buyer will decline every right to any claims for defects, shortcomings in quality or in weight of the object of the sale. In the event of claims promptly placed, the goods will have to be kept at the seller's complete disposal for any checks that may be required. The buyer is not entitled to make use of or tamper with these goods - not even slightly - as this may cause invalidation of any right of claims or complaints.
In the event of the seller recognizing the validity of the claim, he will be obliged to replace the goods, and these will have to be returned in their original state and condition. Any expenses deriving from damage (e.g. battering, denting, etc.) found in the goods will be at the buyer's entire charge. In the event of any contention arising for possible inexactness in the measures of our items, which are expressed in millimetres, the seller declines every responsibility as these must be intended only as approximate.
- Payment: payment of invoices must be effected directly to our registered office in Sabbio Chiese, Via dei Montini, 1 within the established deadline. Delayed payments will involve the application of interests. Until payment has been effected in full, property of the goods will lie with Pasini Metals Productions S.a.S.
- We reserve the right to alter the features of our items or of correcting possible defects at any moment and without any prior notice.
- In case of contentions that might arise, it is expressly established that the competent authority is that of the Court of Brescia.
- By placing orders, the buyer declares that he knows and completely accepts all the above conditions as well as those handwritten or typed in the order(s).



PASINI
ITALIAN LUXURY HANDLES



PASINI
ITALIAN LUXURY HANDLES

**PASINI METALS PRODUCTIONS
DI ICARO E PIERGIACOMO S.A.S.**

Via dei Montini, 1
25070 Sabbio Chiese (Brescia) Italy
Tel (+39) 0365.85142 Fax (+39) 0365.895615
www.pasini.it pasini@pasini.it